



# *Celebrate the Seasons*

Cherry Guidry

Instruction booklet  
& full-size patterns

4 Holiday Quilts | Easy Fusible Appliqué



# *Celebrate the Seasons*

Cherry Guidry

Instruction booklet  
& full-size patterns

4 Holiday Quilts | Easy Fusible Appliqué

Publisher: Amy Marson

Creative Director: Gailen Runge

Art Director: Kristy Zacharias

Editor: Monica Gyulai

Technical Editor: Helen Frost

Cover/Book Designer: Kerry Graham

Production Coordinator: Jenny Davis

Production Editor: Alice Mace Nakanishi

Illustrators: Jessica Jenkins and Cherry Guidry

Photo Assistant: Mary Peyton Peppo

Instructional photography by Diane Pedersen, unless otherwise noted

Published by C&T Publishing, Inc., P.O. Box 1456, Lafayette, CA 94549

# General Instructions

*All four Celebrate the Seasons holiday quilts share the same pieced background layout and borders. Refer to this section for all directions.*

## **FABRIC**

I recommend that you prewash and press all your fabrics before sewing—this way you won't be caught by surprise with fabrics that shrink at different rates or colors that bleed.

Fabric requirements and cutting instructions are based on fabric that is at least 40" wide and allow for both shrinkage from prewashing and some errors when cutting. The fabric amounts for the pieced blocks include some extra that can be used for the appliqués. WOF is an abbreviation for *width of fabric*.

Specific yardage and color requirements are included with each project.

## **SEWING**

All seam allowances are  $\frac{1}{4}$ ". Be as accurate as possible when piecing. The sashing is part of the construction of each block, and accuracy will determine how well your pieced borders will fit.

To keep the batting from migrating through, use a shorter-than-usual stitch length for seams that are pressed open.

## **APPLIQUÉS**

These instructions are for appliqués attached using paper-backed fusible web and machine stitching. Use the layout diagrams in the pattern sheets (P1–P12) when preparing the

appliqué pieces. The patterns are reversed and numbered in appliqué sequence. Choose your favorite fusible web and follow the manufacturer's directions.

## TIP

---

I recommend using Silicone Release Paper (by C&T Publishing) or a translucent nonstick pressing sheet to preassemble the appliqués before fusing them onto the background fabric. Trace, fuse, and cut out the appliqué shapes. Pin the release paper or pressing sheet on top of the pattern page. Assemble and fuse the appliqué pieces right onto the nonstick sheet, remove the assembly from the sheet, and fuse it onto the background fabric.

## Prepare the Appliqués

1. Trace the patterns onto the paper side of the fusible web and write the number on each shape. The numbers indicate the appliqué sequence. Trace 1 of each pattern piece unless otherwise noted.
2. Cut out the traced patterns, leaving about a ¼" margin around each piece, and fuse them to the wrong side of the corresponding fabric.
3. Cut out the appliqué pieces on the traced lines.

## FUSE AND STITCH THE APPLIQUÉD BLOCKS

1. Follow the layout diagrams for Blocks A, B, C, and D, and fuse the appliqué pieces onto the background fabric following the manufacturer's instructions.

## TIP

---

It's a good idea to stabilize your background fabric before adding

appliqués. Cut the background fabric about 1" larger than indicated and spray with starch, saturating the fabric so that when pressed dry, it is as stiff as paper. Fuse and stitch around the appliqué pieces; then cut the background block to the size in the project directions.

2. Stitch around the fused appliqués using a blanket, satin, or zigzag stitch. Use the needle-down feature on your machine if available.

## TIP

---

Test different stitch lengths and widths to get the look you want on the edges of your appliqués. I love to use machine embroidery thread because of its light weight and sheen.

## HAND EMBROIDERY

Some of the quilts require a bit of hand embroidery. Tape the layout diagram to a lightbox or window and place the corresponding appliquéd block on top. Trace the embroidery designs onto the right side of the fabric with a fine-tip pen, such as Micron, in the same color as the floss.

Use two strands of embroidery floss and either a stem stitch or backstitch. Take small, even stitches without pulling too tightly. Your stitching will cover up the fine marker lines.

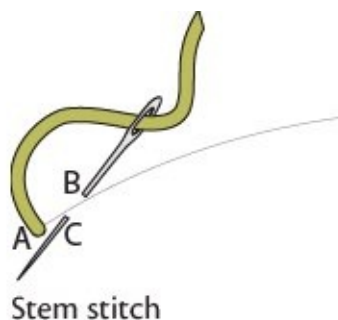

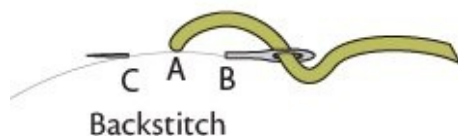

## PIECE THE BACKGROUND BLOCKS

*Cut the fabric as directed in the charts with each project.*

### Blocks A and D

#### Materials

- **Blocks A and D with appliqué:** 2 blocks  $12\frac{1}{2}'' \times 25\frac{1}{2}''$
- **Fabric #2:** 2 strips  $1\frac{1}{2}'' \times 12\frac{1}{2}''$  for sashing

#### Instructions

Sew a sashing strip to the  $12\frac{1}{2}''$  edges: the right edge of Block A and the left edge of Block D. Press the seams toward the sashing.

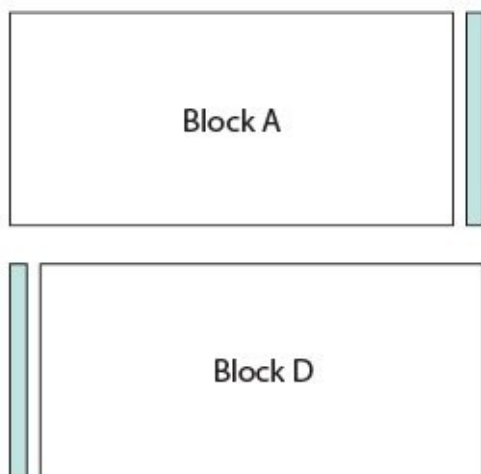

### Block B

#### Materials

- **Block B with appliqué:**  $20\frac{1}{2}'' \times 22\frac{1}{2}''$

- **Fabric #2:** 2 strips  $1\frac{1}{2}'' \times 22\frac{1}{2}''$  for sashing

### Instructions

Sew the sashing strips to the  $22\frac{1}{2}''$  edges of Block B. Press the seams toward the sashing.

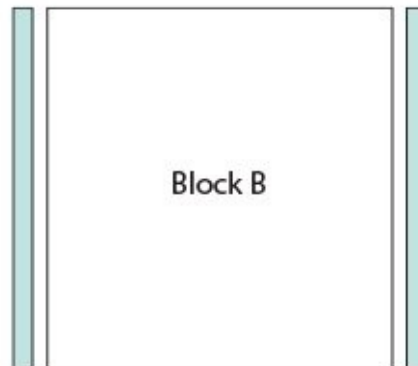

## Block C

### Materials

- **Block C with appliqué:** 2 blocks  $8\frac{1}{2}'' \times 13\frac{1}{2}''$
- **Fabric #2:** 2 strips  $1\frac{1}{2}'' \times 8\frac{1}{2}''$  for sashing

### Instructions

Sew a sashing strip to the  $8\frac{1}{2}''$  edges: the top edge of one Block C and the bottom edge of the other Block C. Press the seams toward the sashing.

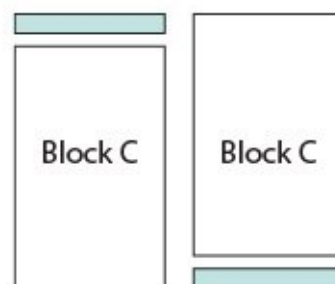



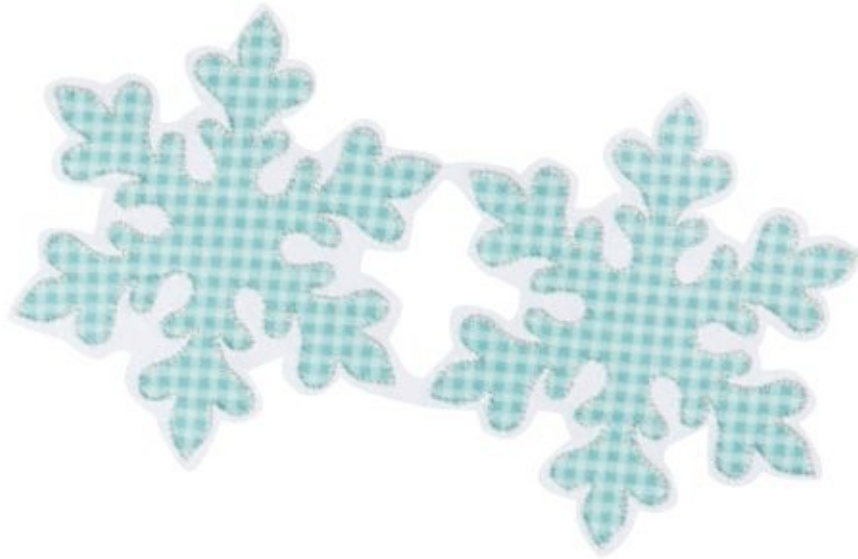

## MAKING THE PIECED BLOCKS

*Note: Use a shorter-than-usual stitch length for better seams and no batting migration.*

### Block E—Pieced Border

#### Materials

- **Background fabric:** 8 strips  $2\frac{1}{2}$ "  $\times$  WOF
  - **Fabric #1:** 4 strips  $2\frac{5}{8}$ "  $\times$  WOF
  - **Fabric #3:** 4 strips  $2\frac{5}{8}$ "  $\times$  WOF
1. Arrange 2 background strips and 1 strip each of Fabrics #1 and #3, with Fabrics #1 and #3 in the middle and the background strips on either side. Sew together to make a strip set. Press all seams open. Repeat for a total of 4 strip sets.
  2. Align the  $45^\circ$  line of a  $5\frac{1}{2}$ " square ruler on the center seam of the pieced strips and cut a  $5\frac{1}{2}$ " square block to make Block E. Repeat to make a total of 20 E blocks.
  3. Join 10 E blocks, alternating the direction of the seams, for

each of the 2 pieced borders.

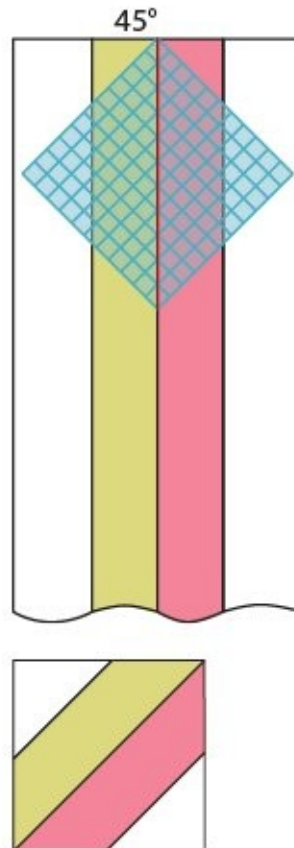
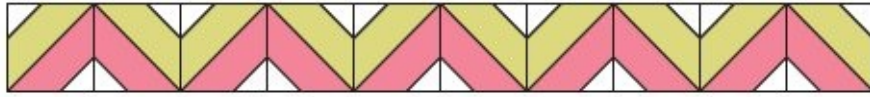

## Block F

### Materials

- **Background fabric:** 6 strips  $2\frac{5}{8}$ "  $\times$  WOF
  - **Fabric #1:** 2 strips  $2\frac{5}{8}$ "  $\times$  WOF
  - **Fabric #3:** 2 strips  $2\frac{5}{8}$ "  $\times$  WOF
1. Arrange 3 background strips and 1 strip each of Fabrics #1 and #3. Sew together, offsetting the top of each strip 2" as shown. Press all seams open.

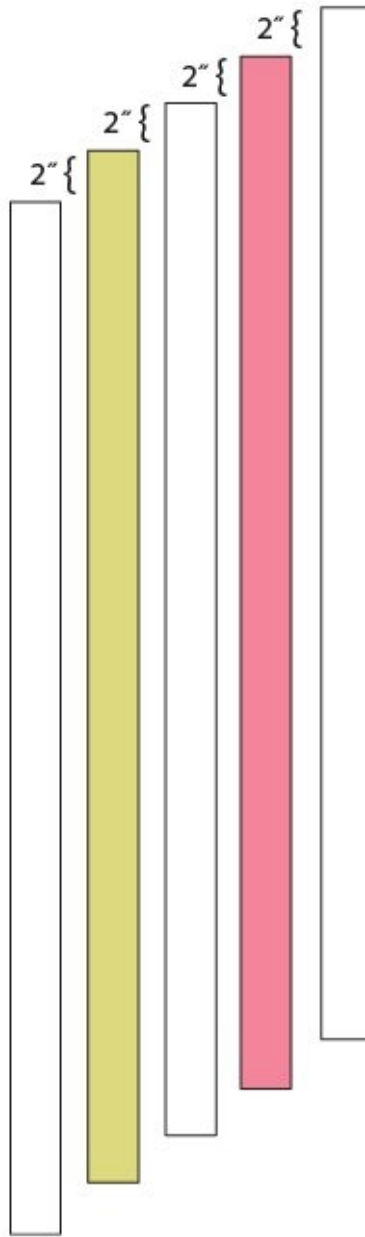

2. Sew a second strip set, staggering the strips in the opposite direction.

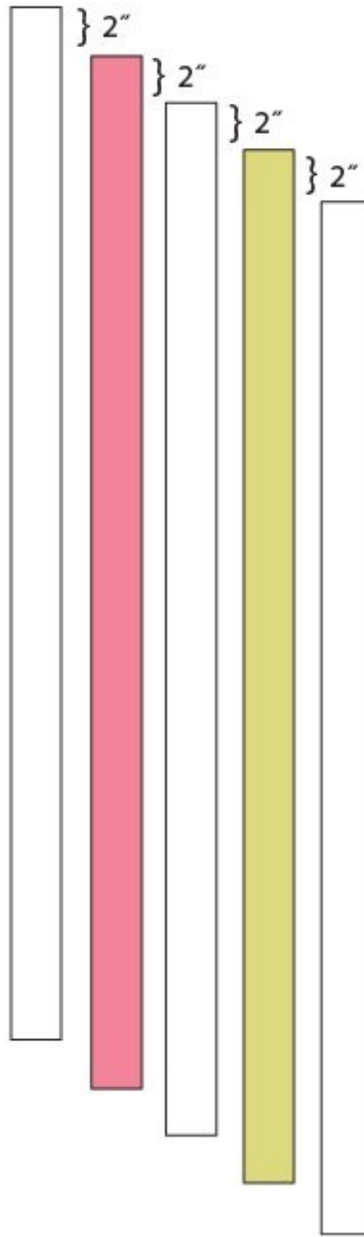

3. With Fabric #1 toward the top, align the 45° line of a 6" × 24" ruler on the top edge of the first strip set. Trim the end at an angle and cut 4 sections 3½" wide.

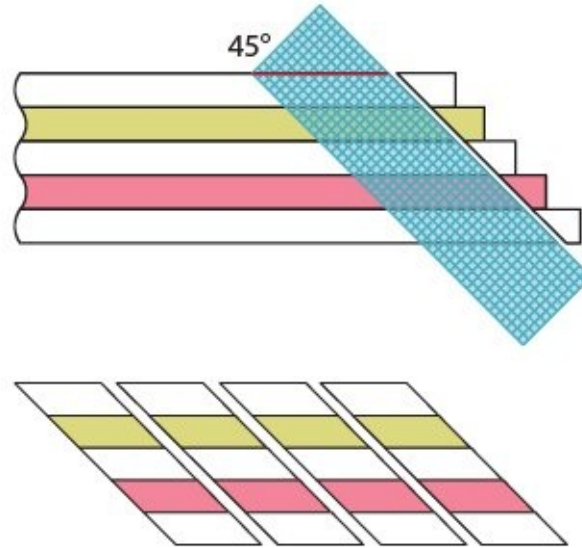

4. With Fabric #1 toward the top, align the 45° line of a 6" × 24" ruler on the bottom edge of the second strip set. Trim the end at an angle and cut 4 sections 3½" wide.

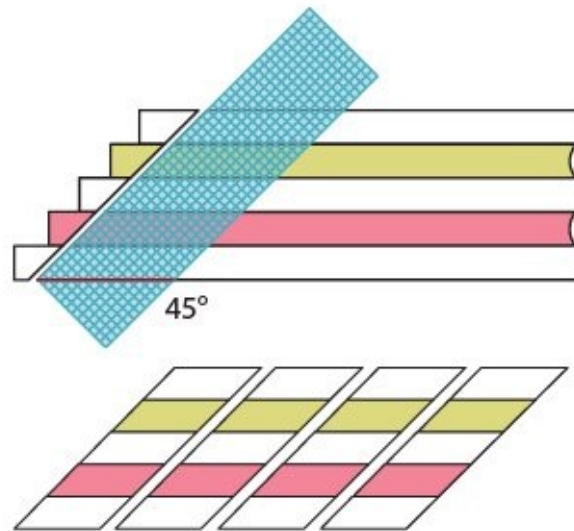

5. Arrange and sew together 4 sections to make Block F.

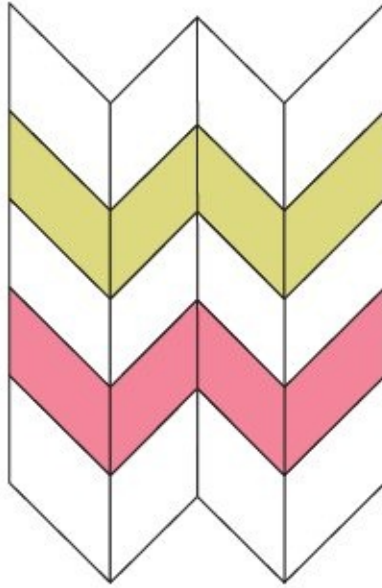

6. Trim the block into a  $12\frac{1}{2}$ " square, leaving a  $\frac{1}{4}$ " seam allowance beyond the points of Fabrics #1 and #2. Make 2 F blocks.

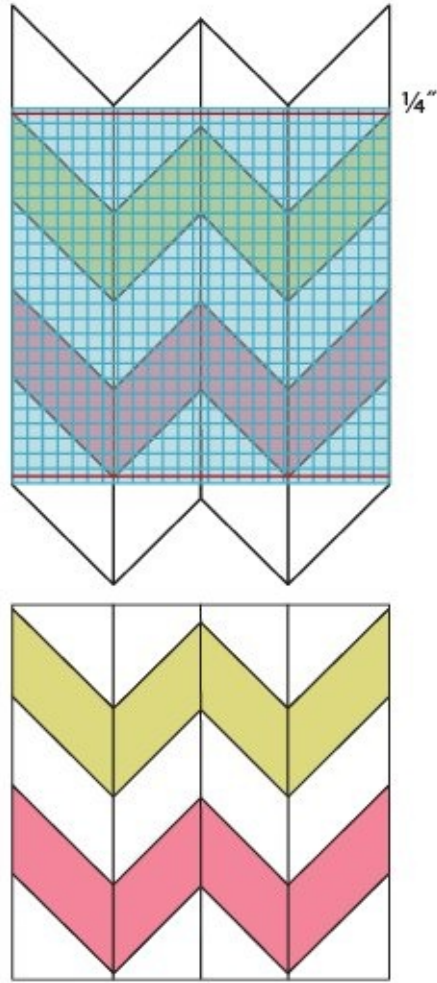

## Block G

### Materials

- **Background fabric:** 4 strips  $2\frac{1}{2}'' \times \text{WOF}$
- **Fabric #1:** 2 strips  $2\frac{3}{8}'' \times \text{WOF}$
- **Fabric #3:** 2 strips  $2\frac{3}{8}'' \times \text{WOF}$

Refer to [Block F illustrations](#) for extra guidance.

1. Arrange 2 background strips and 1 strip each of Fabrics #1 and #3, with Fabrics #1 and #3 in the middle and the background strips on either side. Sew together, offsetting the

- top of each strip 2". Press all seams open.
2. Sew a second strip set, staggering the strips in the opposite direction.
  3. With Fabric #1 toward the top, align the 45° line of a 6" × 24" ruler on the top edge of the first strip set. Trim the end at an angle and cut 4 sections 3¼" wide.
  4. With Fabric #1 toward the top, align the 45° line of a 6" × 24" ruler on the bottom edge of the second strip set. Trim the end at an angle and cut 2 sections 3¼" wide.
  5. Arrange and sew together 3 sections to make Block G.

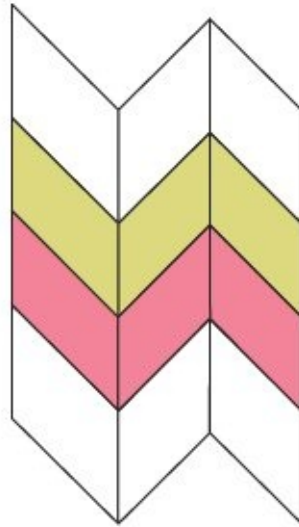

6. Trim the block into an 8½" square, leaving a ¼" seam allowance beyond the points of Fabrics #1 and #2. Make 2 G blocks, either the same or mirror images.



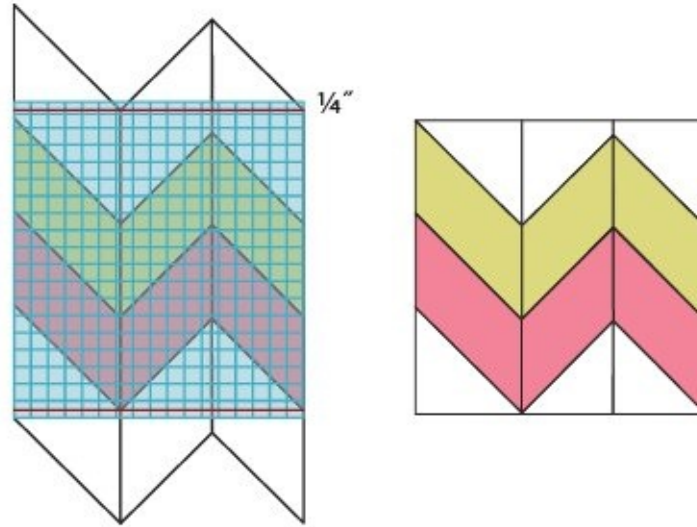

## Border #1

### Materials

■ **Background fabric:** 3 strips  $5\frac{1}{2}'' \times \text{WOF}$

■ **Fabric #3:** 4 squares  $3\frac{1}{2}'' \times 3\frac{1}{2}''$

1. Make 2 Border #1 pieces by first sewing together 3 background strips end to end. Cut 2 pieces, each  $50\frac{1}{2}''$  long.
2. Draw a diagonal line on the wrong side of the 4 squares of Fabric #3.
3. Following the diagram, sew the squares to 2 corners of each of the Border #1 pieces with right sides facing.
4. Press the triangles toward the corner and trim the excess fabric underneath the triangle, leaving a  $\frac{1}{4}''$  seam allowance.

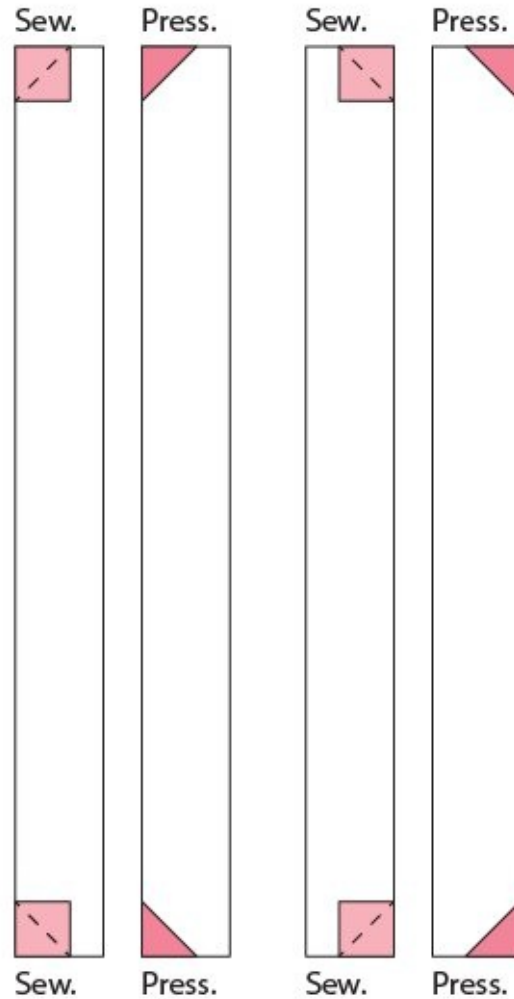

## ASSEMBLE THE QUILT TOP

*Note: Press all seams toward the sashing fabric unless otherwise noted.*

### Quilt Center

1. Sew Block A to the left edge of a Block F.
2. Sew a Block G to the top edge of a Block C.
3. Sew a Block C to the top edge of a Block G.
4. Sew the GC unit from Step 2 to the left edge of Block B.

5. Sew the CG unit from Step 3 to the right edge of Block B.
6. Sew a Block F to the left edge of Block D.

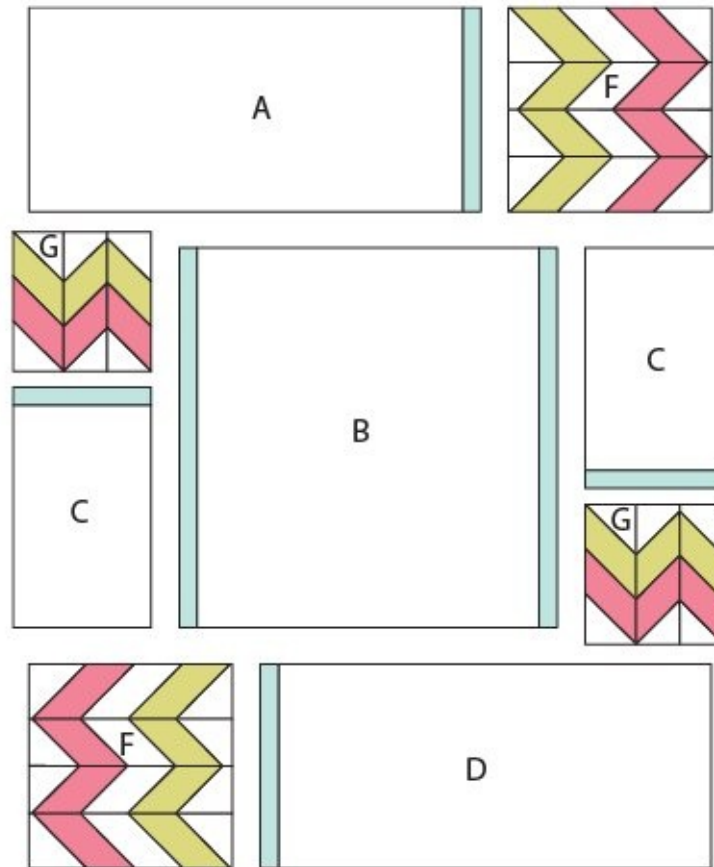

Quilt center assembly

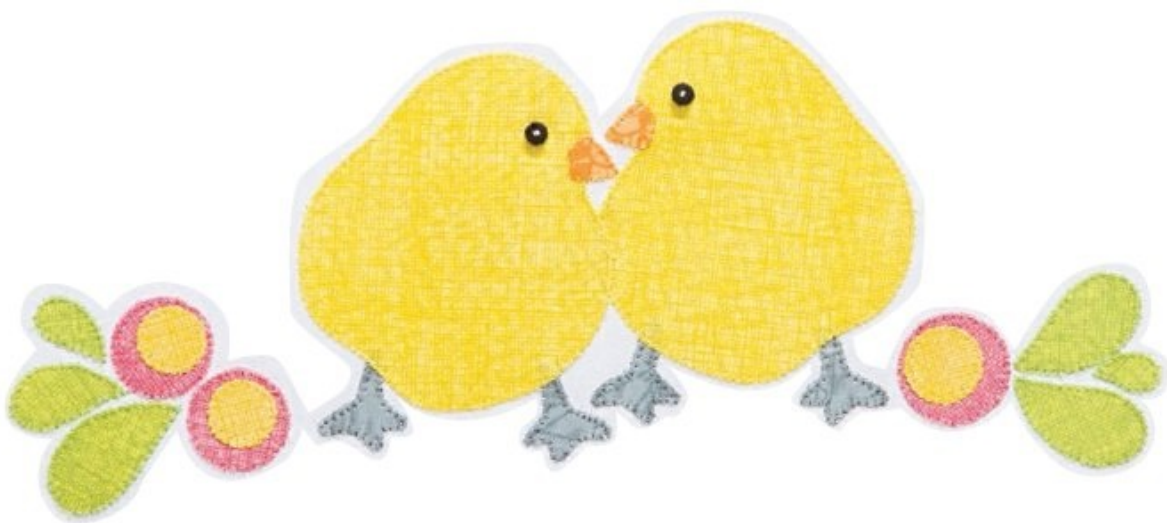

## Sashing and Borders

### Materials

- **Background fabric:** 3 strips  $2\frac{1}{2}$ "  $\times$  WOF for Border #4
- **Fabric #1:** 3 strips 3"  $\times$  WOF for Border #2 and 3 strips 1"  $\times$  WOF for Border #3
- **Fabric #2:** 7 strips  $1\frac{1}{2}$ "  $\times$  WOF for sashing
- **Large print:** 3 strips 5"  $\times$  WOF for Border #5
- **Border #1:** 2
- **Pieced border:** 2
  1. Make 2 sashing A pieces by trimming 2 Fabric #2 strips to  $38\frac{1}{2}$ " long. Sew to the top and bottom edges of the GC-B-CG center unit.
  2. Sew the AF unit to the top edge of the center unit.
  3. Sew the FD unit to the bottom edge of the center unit.
  4. Make 2 sashing B pieces by first sewing together 3 Fabric #2 strips end to end. Cut 2 pieces, each  $48\frac{1}{2}$ " long. Sew to the side edges of the quilt center.
  5. Make 2 sashing C pieces by trimming 2 Fabric #2 strips to  $40\frac{1}{2}$ " long. Sew to the top and bottom edges of the quilt center.
  6. Sew the Border #1 pieces to the side edges of the quilt center.
  7. Sew the pieced borders to the top and bottom edges of the quilt center.
  8. Make 2 Border #2 pieces by first sewing together 3 Fabric #1 strips 3" wide end to end. Cut 2 pieces, each  $60\frac{1}{2}$ " long. Sew to the side edges of the quilt center; press

toward Border #2.

- 9.** Make 2 Border #3 pieces by first sewing together 3 Fabric #1 strips 1" wide end to end. Cut 2 pieces, each 55½" long. Sew to the top and bottom edges of the quilt center; press toward Border #3.
- 10.** Make 2 Border #4 pieces by first sewing 3 background strips end to end. Cut 2 pieces, each 55½" long. Sew to the top and bottom edges of the quilt center; press toward Border #3.
- 11.** Make 2 Border #5 pieces by first sewing together 3 large-print border strips end to end. Cut 2 strips, each 55½" long. Sew to the top and bottom edges of the quilt center; press toward Border #5.

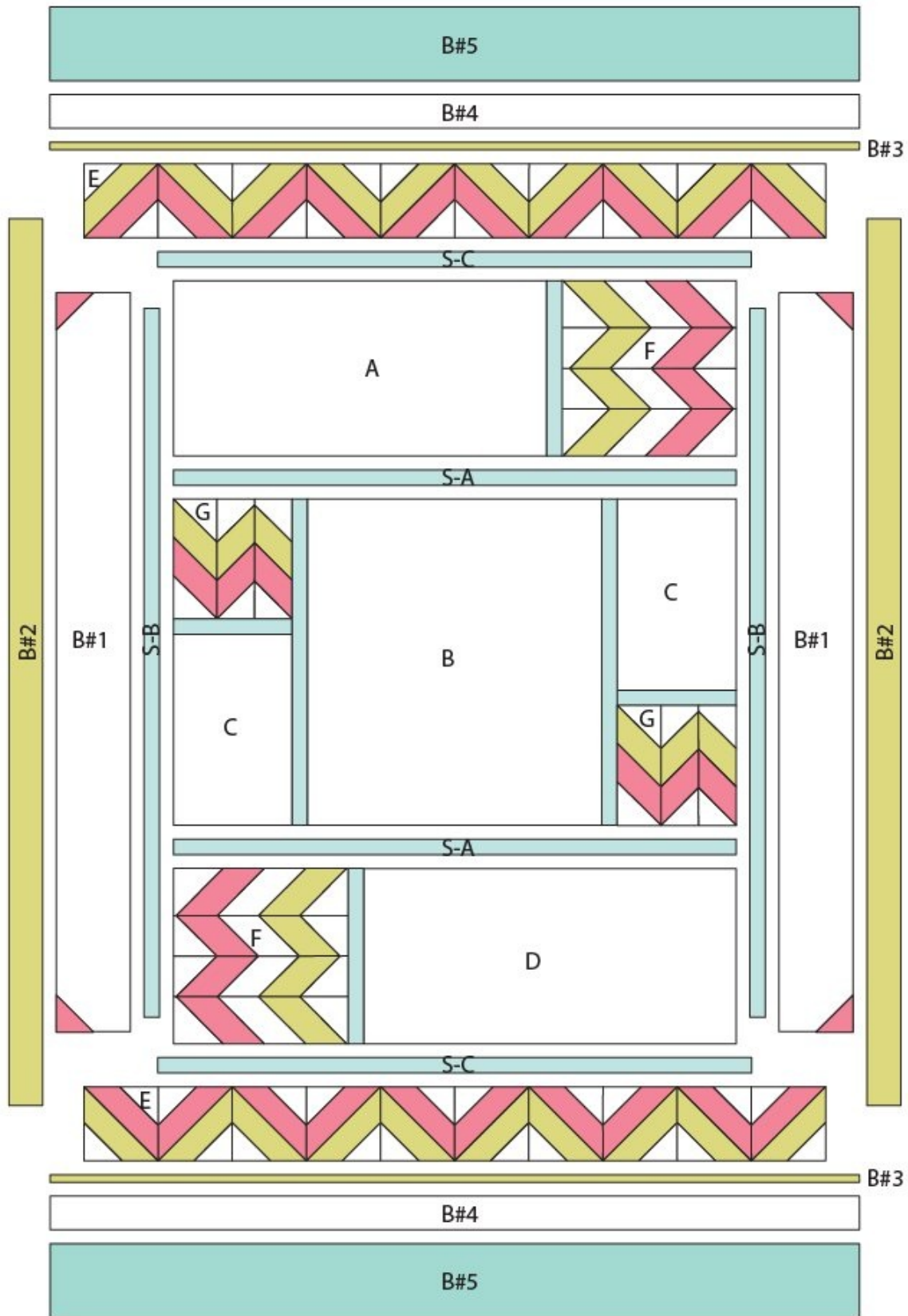

Refer to this diagram when assembling all the quilts.

## **FINISHING**

- 1.** Place the backing fabric right side down. Place the batting over the backing and center the quilt top on top of the batting.
- 2.** Baste or pin together and quilt as desired.
- 3.** Trim the excess batting and backing.
- 4.** Sew together the binding strips and attach to the quilt using your preferred method.
- 5.** Label your quilt and enjoy!

*Spring*



**SPRING BASKET**



## FINISHED QUILT: 55½" × 74½"

### Materials and Cutting

SUPPLIES	YARDAGE	CUT
Appliqué fabrics	Scraps to total 1 yard	A variety of large scraps in spring colors: 2 pinks, 2 greens, aqua, yellow, orange, gray, various prints for eggs
Background fabric (white)	3¾ yards	8 strips 2½" × WOF for Block E 6 strips 2¾" × WOF for Block F 4 strips 2½" × WOF for Block G 2 strips 12½" × WOF; subcut into 2 pieces 12½" × 25½" for Blocks A and D 1 strip 20½" × WOF; subcut into 1 piece 20½" × 22½" for Block B 1 strip 8½" × WOF; subcut into 2 pieces 8½" × 13½" for Block C 3 strips 5½" × WOF for Border #1 3 strips 2½" × WOF for Border #4
Fabric #1 (green)	1¼ yards	4 strips 2¾" × WOF for Block E 2 strips 2¾" × WOF for Block F 2 strips 2¾" × WOF for Block G 3 strips 3" × WOF for Border #2 3 strips 1" × WOF for Border #3
Fabric #2 (small aqua / pink print)	½ yard	10 strips 1½" × WOF for sashing; subcut 3 of these strips into • 2 pieces 1½" × 12½" for Blocks A and D • 2 pieces 1½" × 22½" for Block B • 2 pieces 1½" × 8½" for Block C
Fabric #3 (pink)	1 yard	4 strips 2¾" × WOF for Block E 2 strips 2¾" × WOF for Block F 2 strips 2¾" × WOF for Block G 1 strip 3½" × WOF; subcut into 4 squares 3½" for Border #1
Large print	¾ yard	3 strips 5" × WOF for Border #5
Binding (stripe)	½ yard (or ¾ yard for bias)	7 strips 2¼" × WOF
Backing	4 yards	62" × 81" (pieced crosswise)
Batting	Twin size	
Fusible (17" wide)	2½ yards	
Additional supplies	Thread to match appliqués, 2 buttons ¼" for chick eyes	

## MAKING THE QUILT

1. Gather your supplies and cut fabric as directed in the chart.
2. Use the *Spring Basket* reversed appliqué patterns as follows:
  - BLOCK A:** pattern sheet
  - BLOCK B:** pattern sheet
  - BLOCK C:** pattern sheet (Make 2 of these blocks.)
  - BLOCK D:** pattern sheet
3. Refer to [General Instructions](#) to prepare the appliqués, piece the blocks, assemble the quilt top, and finish.



*Summer*



**LIBERTY**

## FINISHED QUILT: 55½" × 74½"

### Materials and Cutting

SUPPLIES	YARDAGE	CUT
Appliqué fabrics	Scraps to total 1 yard	A variety of large scraps in patriotic colors: red, white, blue
Background fabric (white)	3¾ yards	<p>8 strips 2½" × WOF for Block E</p> <p>6 strips 2¾" × WOF for Block F</p> <p>4 strips 2½" × WOF for Block G</p> <p>2 strips 12½" × WOF; subcut into 2 pieces 12½" × 25½" for Blocks A and D</p> <p>1 strip 20½" × WOF; subcut into 1 piece 20½" × 22½" for Block B</p> <p>1 strip 8½" × WOF; subcut into 2 pieces 8½" × 13½" for Block C</p> <p>3 strips 5½" × WOF for Border #1</p> <p>3 strips 2½" × WOF for Border #4</p>
Fabric #1 (dark blue)	1¼ yards	<p>4 strips 2¾" × WOF for Block E</p> <p>2 strips 2¾" × WOF for Block F</p> <p>2 strips 2¾" × WOF for Block G</p> <p>3 strips 3" × WOF for Border #2</p> <p>3 strips 1" × WOF for Border #3</p>
Fabric #2 (medium blue)	½ yard	<p>10 strips 1½" × WOF for sashing; subcut 3 of these strips into</p> <ul style="list-style-type: none"> <li>• 2 pieces 1½" × 12½" for Blocks A and D</li> <li>• 2 pieces 1½" × 22½" for Block B</li> <li>• 2 pieces 1½" × 8½" for Block C</li> </ul>
Fabric #3 (red)	1 yard	<p>4 strips 2¾" × WOF for Block E</p> <p>2 strips 2¾" × WOF for Block F</p> <p>2 strips 2¾" × WOF for Block G</p> <p>1 strip 3½" × WOF; subcut into 4 squares 3½" for Border #1</p>
Large print	¾ yard (1 yard to also use for appliqués)	3 strips 5" × WOF for Border #5
Binding (red)	½ yard (or ¾ yard for bias)	7 strips 2¼" × WOF
Backing	4 yards	62" × 81" (pieced crosswise)
Batting	Twin size	
Fusible (17" wide)	2½ yards	
Additional supplies	Thread to match appliqués	13 small ½" star buttons for map

## MAKING THE QUILT

1. Gather your supplies and cut fabric as directed in the chart.

2. Use the *Liberty* reversed appliqué patterns as follows:

**BLOCK A:** pattern sheet

**BLOCK B:** pattern sheet

**BLOCK C:** pattern sheet (Make 2 of these blocks.)

**BLOCK D:** pattern sheet

3. Refer to [General Instructions](#) to prepare the appliqués, piece the blocks, assemble the quilt top, and finish.

Fall



THANKFUL

## FINISHED QUILT: 55½" × 74½"

### Materials and Cutting

SUPPLIES	YARDAGE	CUT
Appliqué fabrics	Scraps to total 1 yard	A variety of large scraps in fall colors: 3 greens, brown, 4 oranges, 2 reds, purple, 3 yellows, 2 teals
Background fabric (white)	3¾ yards	8 strips 2½" × WOF for Block E 6 strips 2¾" × WOF for Block F 4 strips 2½" × WOF for Block G 2 strips 12½" × WOF; subcut into 2 pieces 12½" × 25½" for Blocks A and D 1 strip 20½" × WOF; subcut into 1 piece 20½" × 22½" for Block B 1 strip 8½" × WOF; subcut into 2 pieces 8½" × 13½" for Block C 3 strips 5½" × WOF for Border #1 3 strips 2½" × WOF for Border #4
Fabric #1 (orange)	1¼ yards	4 strips 2¾" × WOF for Block E 2 strips 2¾" × WOF for Block F 2 strips 2¾" × WOF for Block G 3 strips 3" × WOF for Border #2 3 strips 1" × WOF for Border #3
Fabric #2 (orange dot)	½ yard	10 strips 1½" × WOF for sashing; subcut 3 of these strips into • 2 pieces 1½" × 12½" for Blocks A and D • 2 pieces 1½" × 22½" for Block B • 2 pieces 1½" × 8½" for Block C
Fabric #3 (yellow)	1 yard	4 strips 2¾" × WOF for Block E 2 strips 2¾" × WOF for Block F 2 strips 2¾" × WOF for Block G 1 strip 3½" × WOF; subcut into 4 squares 3½" for Border #1
Large print	⅝ yard	3 strips 5" × WOF for Border #5
Binding (multicolor or same as large print)	½ yard (⅜ yard for bias)	7 strips 2¼" × WOF
Backing	4 yards	62" × 81" (pieced crosswise)
Batting	Twin size	
Fusible (17" wide)	2½ yards	
Additional supplies		Thread to match appliqués Green embroidery floss 2 mini buttons for bird eyes



## MAKING THE QUILT

1. Gather your supplies and cut fabric as directed in the chart.

2. Use the *Thankful* reversed appliqué patterns as follows:

**BLOCK A:** pattern sheet

**BLOCK B:** pattern sheet

**BLOCK C:** pattern sheet (Make 2 of these blocks.)

**BLOCK D:** pattern sheet

3. Refer to [General Instructions](#) to prepare the appliqués, piece the blocks, assemble the quilt top, and finish.

*Winter*



**MERRY and BRIGHT**

## FINISHED QUILT: 55½" × 74½"

### Materials and Cutting

SUPPLIES	YARDAGE	CUT
Appliqué fabrics	Scraps to total 1 yard	A variety of large scraps in winter colors: 3 reds, 4 greens, aqua, gray, teal, white, orange, black
Background fabric (white)	3¼ yards	8 strips 2½" × WOF for Block E 6 strips 2¾" × WOF for Block F 4 strips 2½" × WOF for Block G 2 strips 12½" × WOF; subcut into 2 pieces 12½" × 25½" for Blocks A and D 1 strip 8½" × WOF; subcut into 2 pieces 8½" × 13½" for Block C 3 strips 5½" × WOF for Border #1 3 strips 2½" × WOF for Border #4
Fabric #1 (green)	1¼ yards	4 strips 2¾" × WOF for Block E 2 strips 2¾" × WOF for Block F 2 strips 2¾" × WOF for Block G 3 strips 3" × WOF for Border #2 3 strips 1" × WOF for Border #3
Fabric #2 (red dot)	½ yard	10 strips 1½" × WOF for sashing; subcut 3 of these strips into • 2 pieces 1½" × 12½" for Blocks A and D • 2 pieces 1½" × 22½" for Block B • 2 pieces 1½" × 8½" for Block C
Fabric #3 (aqua)	1¾ yards	1 strip 20½" × WOF; subcut into 1 piece 20½" × 22½" for Block B 4 strips 2¾" × WOF for Block E 2 strips 2¾" × WOF for Block F 2 strips 2¾" × WOF for Block G 1 strip 3½" × WOF; subcut into 4 squares 3½" for Border #1
Large print	¾ yard	3 strips 5" × WOF for Border #5
Binding (red stripe)	½ yard (¾ yard for bias)	7 strips 2¼" × WOF
Backing	4 yards	62" × 81" (pieced crosswise)
Batting	Twin size	
Fusible (17" wide)	2½ yards	
Additional supplies	Thread to match appliqués Green embroidery floss	

## MAKING THE QUILT

1. Gather your supplies and cut fabric as directed in the chart.
2. Use the *Merry and Bright* reversed appliqué patterns as follows:

**BLOCK A:** pattern sheet

**BLOCK B:** pattern sheet

**BLOCK C:** pattern sheet (Make 2 of these blocks.)

**BLOCK D:** pattern sheet

3. Refer to [General Instructions](#) to prepare the appliqués, piece the blocks, assemble the quilt top, and finish.

## About the Author

---



Cherry's love affair with fabric and sewing began at age four when her mom taught her to sew clothes for her dolls, and she has been an avid quilter since taking her first quilting class in 2004. She now markets her own patterns under the Cherry Blossoms label and designs fabric for Benartex.

Cherry lives with her family in Louisiana.

For more information on Cherry Blossoms patterns, please visit [cherryblossomsquilting.com](http://cherryblossomsquilting.com).

If you love quilting, sewing, fiber arts & more—join our email list for updates, special offers and discounts, author news, and the latest links to great freebies and giveaways! (Don't worry, we won't share your info with anyone.)

[http://www.ctpub.com/client/client\\_pages/newsletterB2C.cfm](http://www.ctpub.com/client/client_pages/newsletterB2C.cfm)

## More Inspiration

---



This little pillow was made with the leftover strips from Block F.



Fun and easy tea towels



Quick runner made with the appliques  
from Block A in *Thankful*

## Spring Basket: block A

Note: Patterns are also printed in reverse for fusible appliqué.

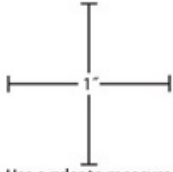

Use a ruler to measure these inch marks to verify that printout is correctly sized.

To make complete pattern, join the following pages, following the diagram for reference.

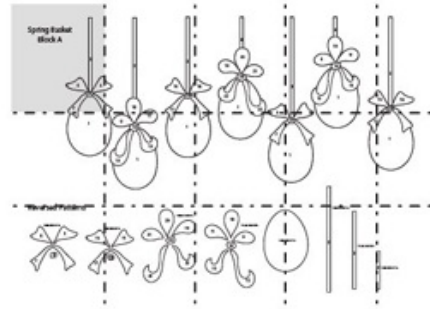

# Spring Basket Block A

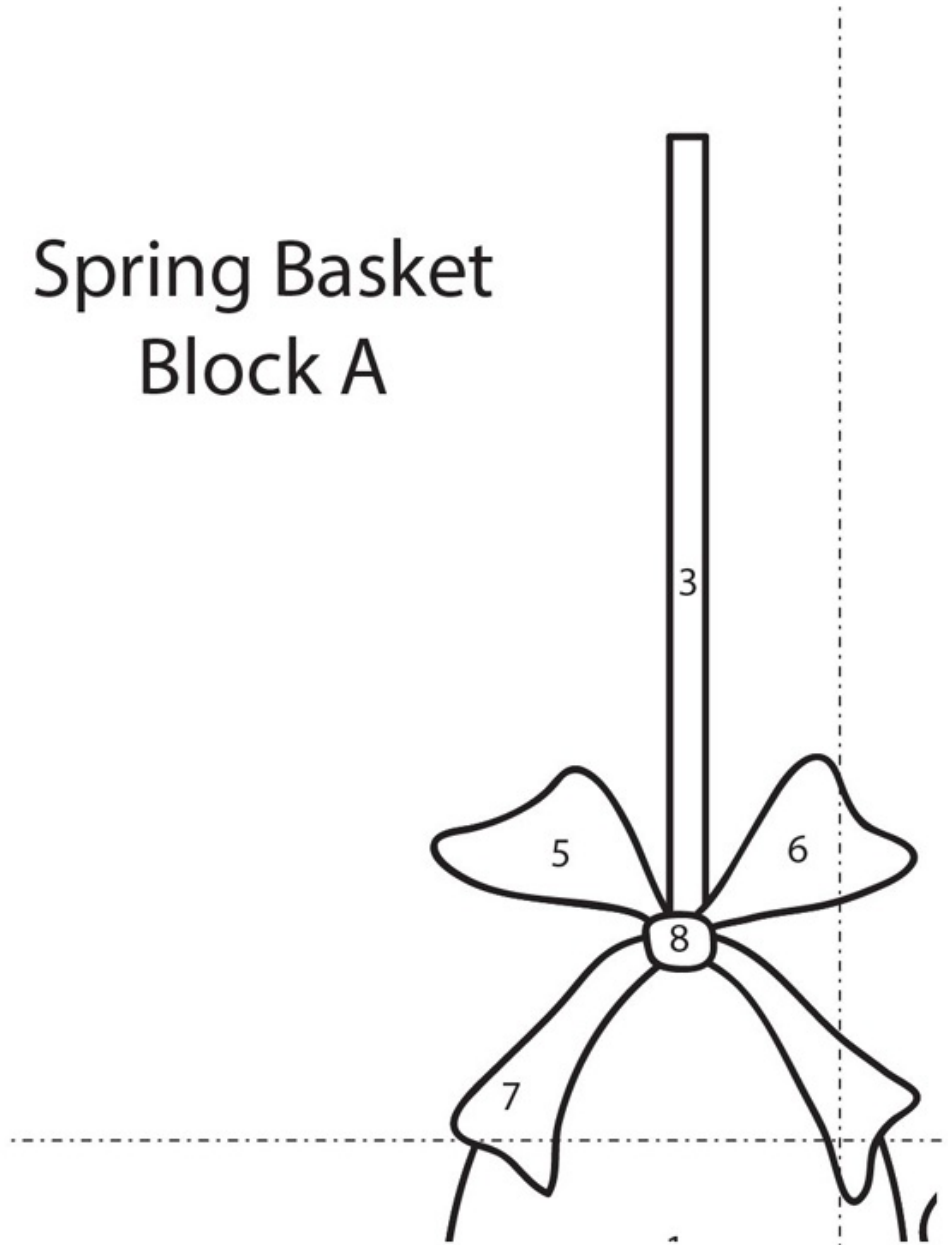



For all printable patterns or digital content: <http://tinyurl.com/11106-patterns-download>

# Spring Basket: block A

Note: Patterns are also printed in reverse for fusible appliqué.

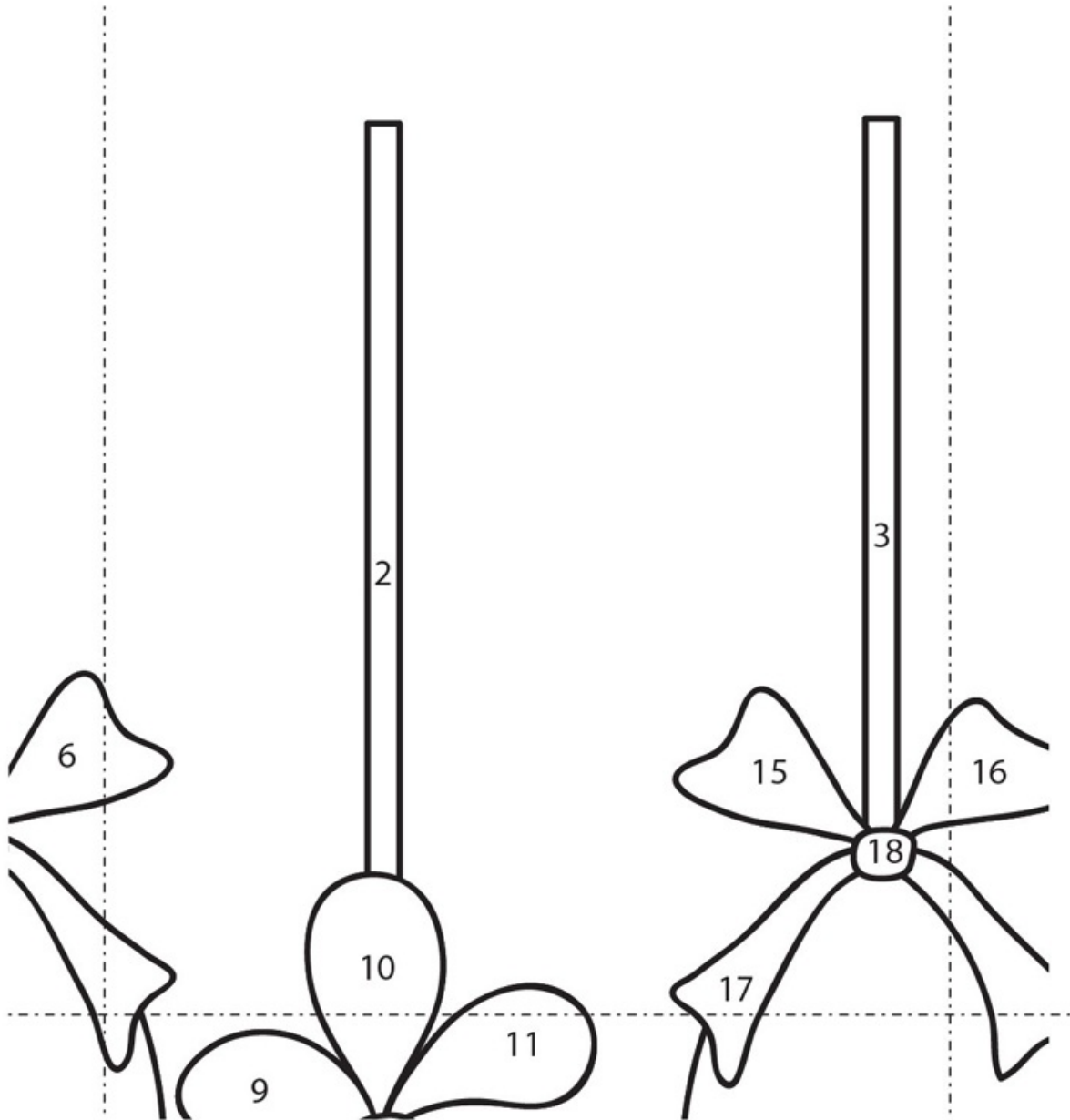
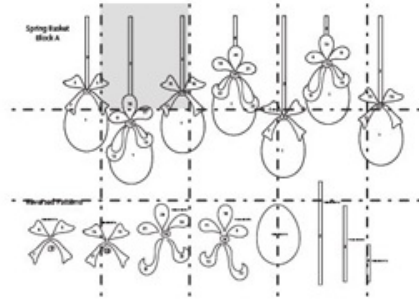
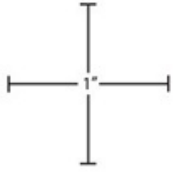

For all printable patterns or digital content: <http://tinyurl.com/11106->

### Spring Basket: block A

Note: Patterns are also printed in reverse for fusible appliqué.

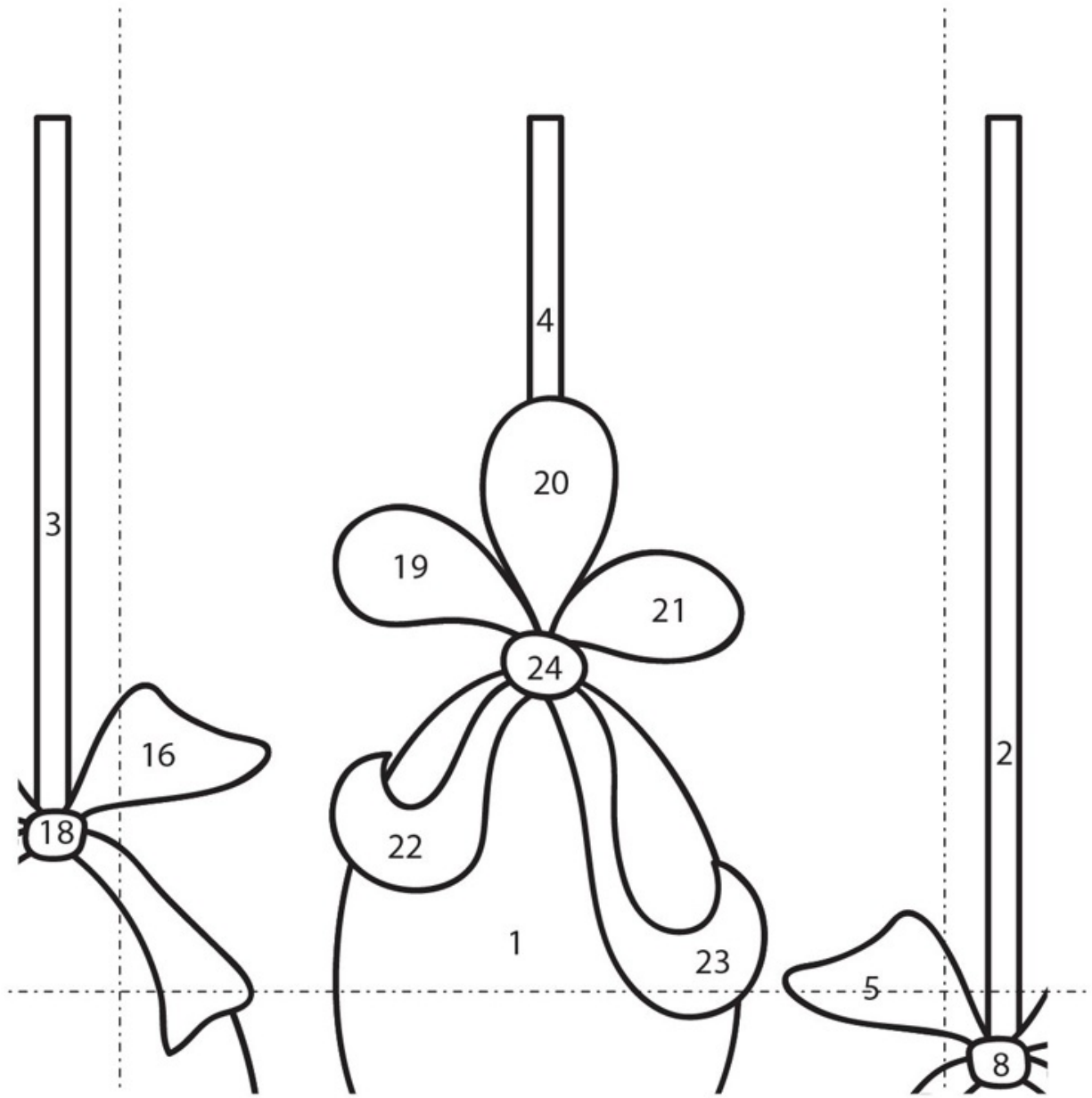
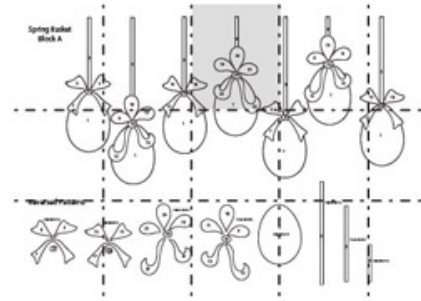
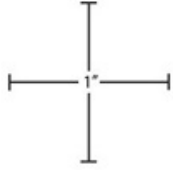

For all printable patterns or digital content: <http://tinyurl.com/11106-patterns-download>

## Spring Basket: block A

Note: Patterns are also printed in reverse for fusible appliqué.

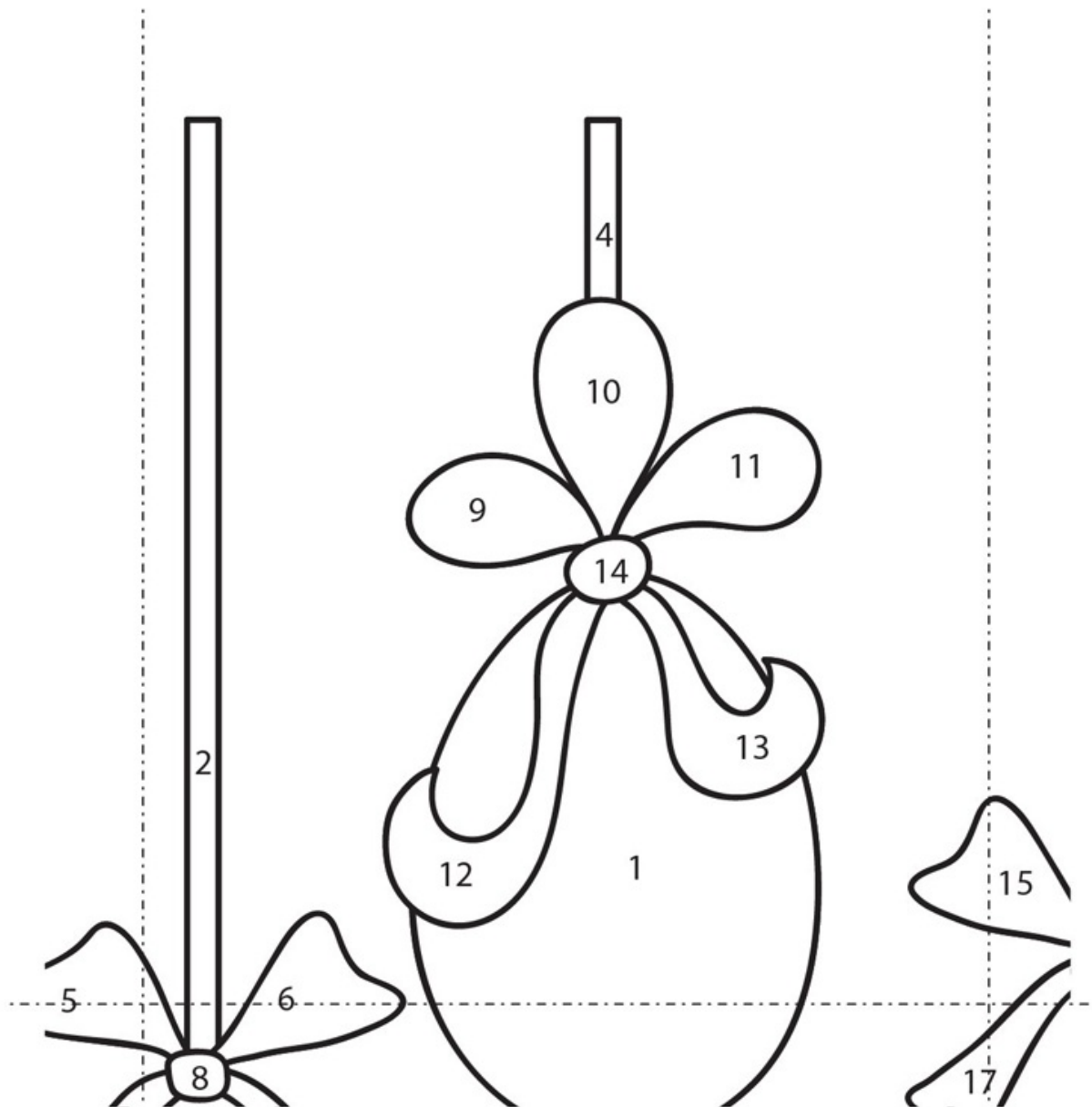
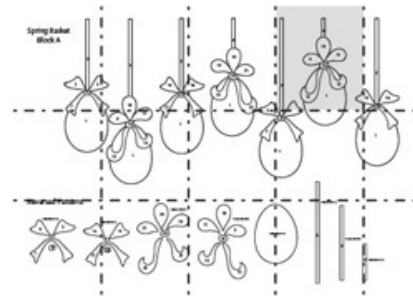
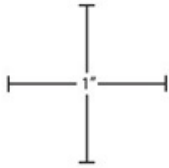

For all printable patterns or digital content: <http://tinyurl.com/11106->

patterns-download

# Spring Basket: block A

Note: Patterns are also printed in reverse for fusible appliqué.

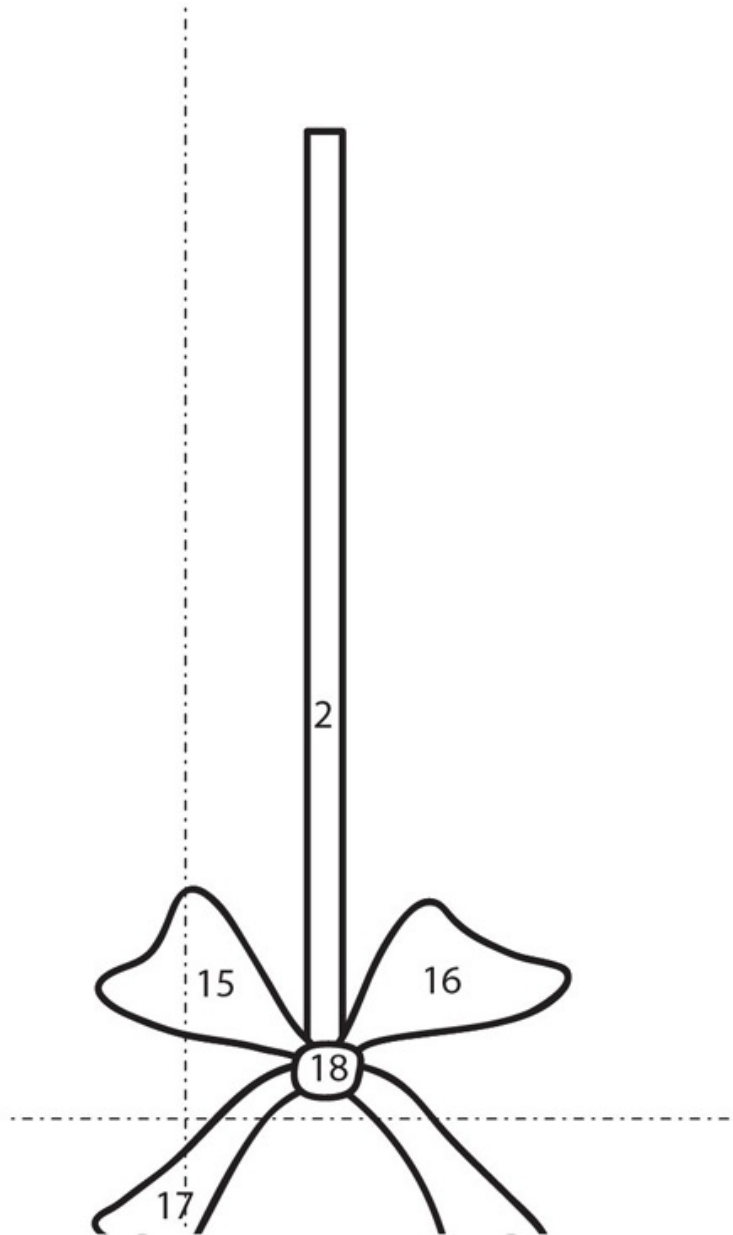
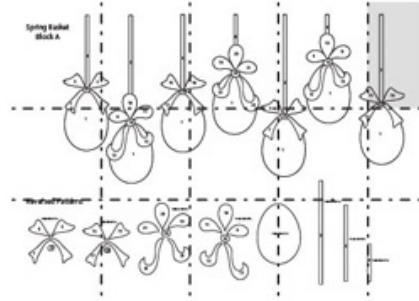
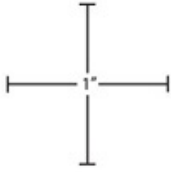

For all printable patterns or digital content: <http://tinyurl.com/11106-patterns-download>



## Spring Basket: block A

Note: Patterns are also printed in reverse for fusible appliqué.

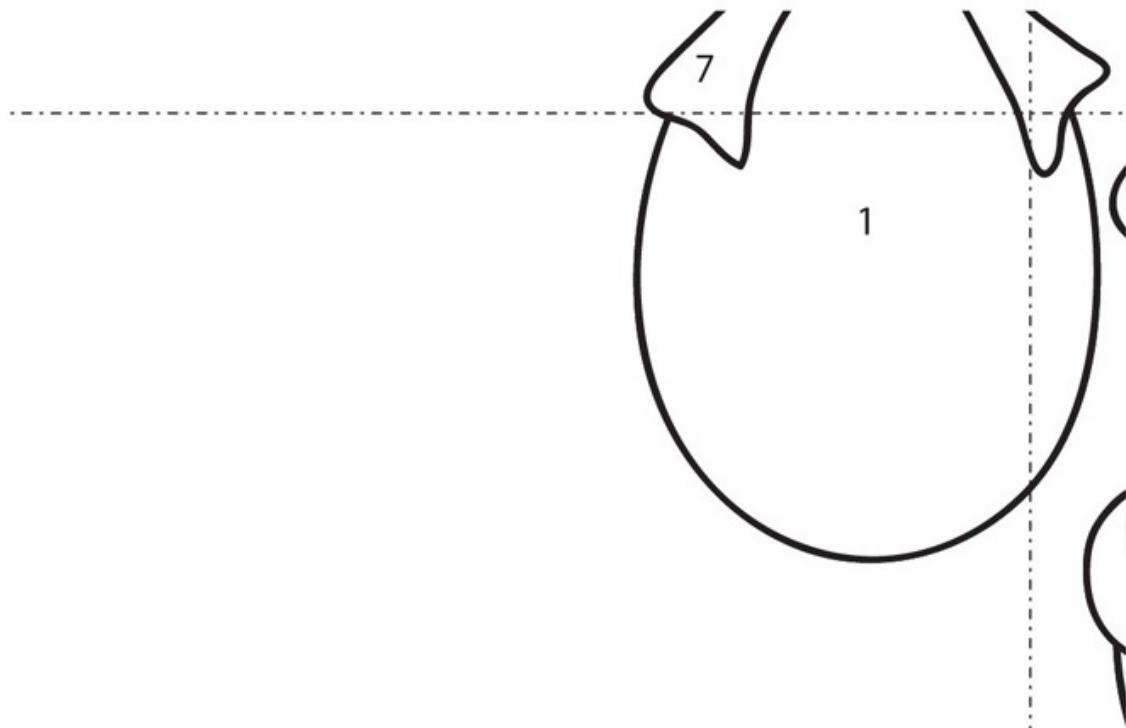
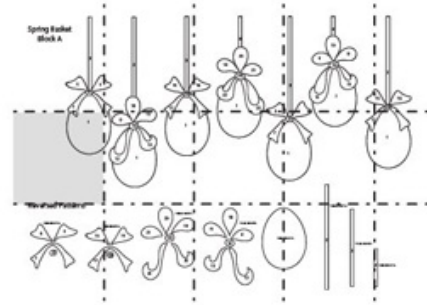
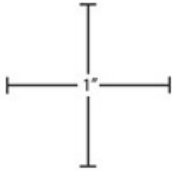

Reversed Patterns

For all printable patterns or digital content: <http://tinyurl.com/11106-patterns-download>

# Spring Basket: block A

Note: Patterns are also printed in reverse for fusible appliqué.

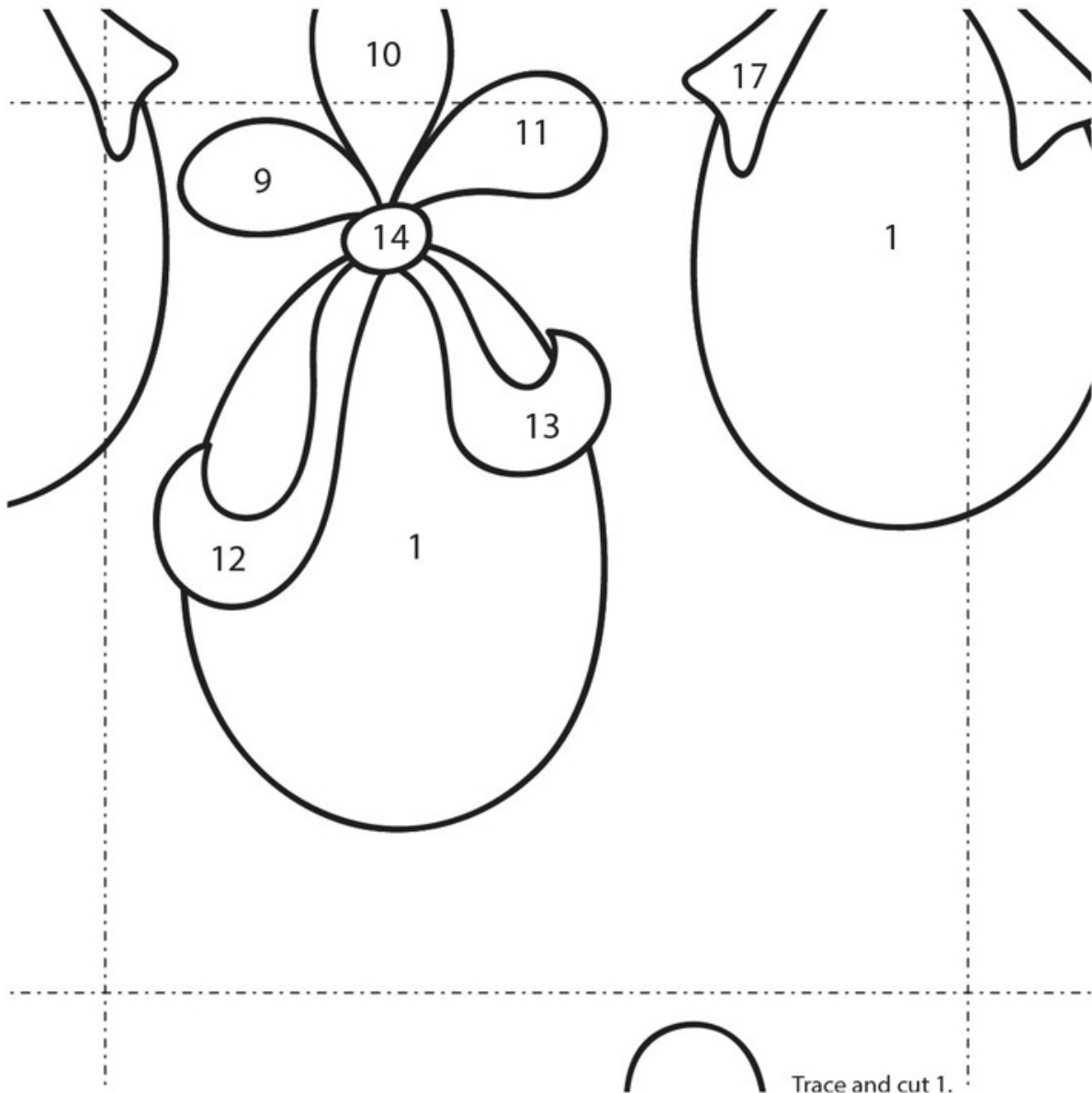
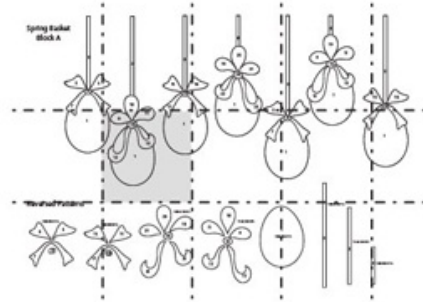
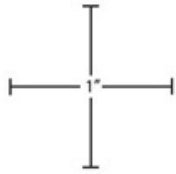

For all printable patterns or digital content: <http://tinyurl.com/11106->

patterns-download

Spring Basket: block A

Note: Patterns are also printed in reverse for fusible appliqué.

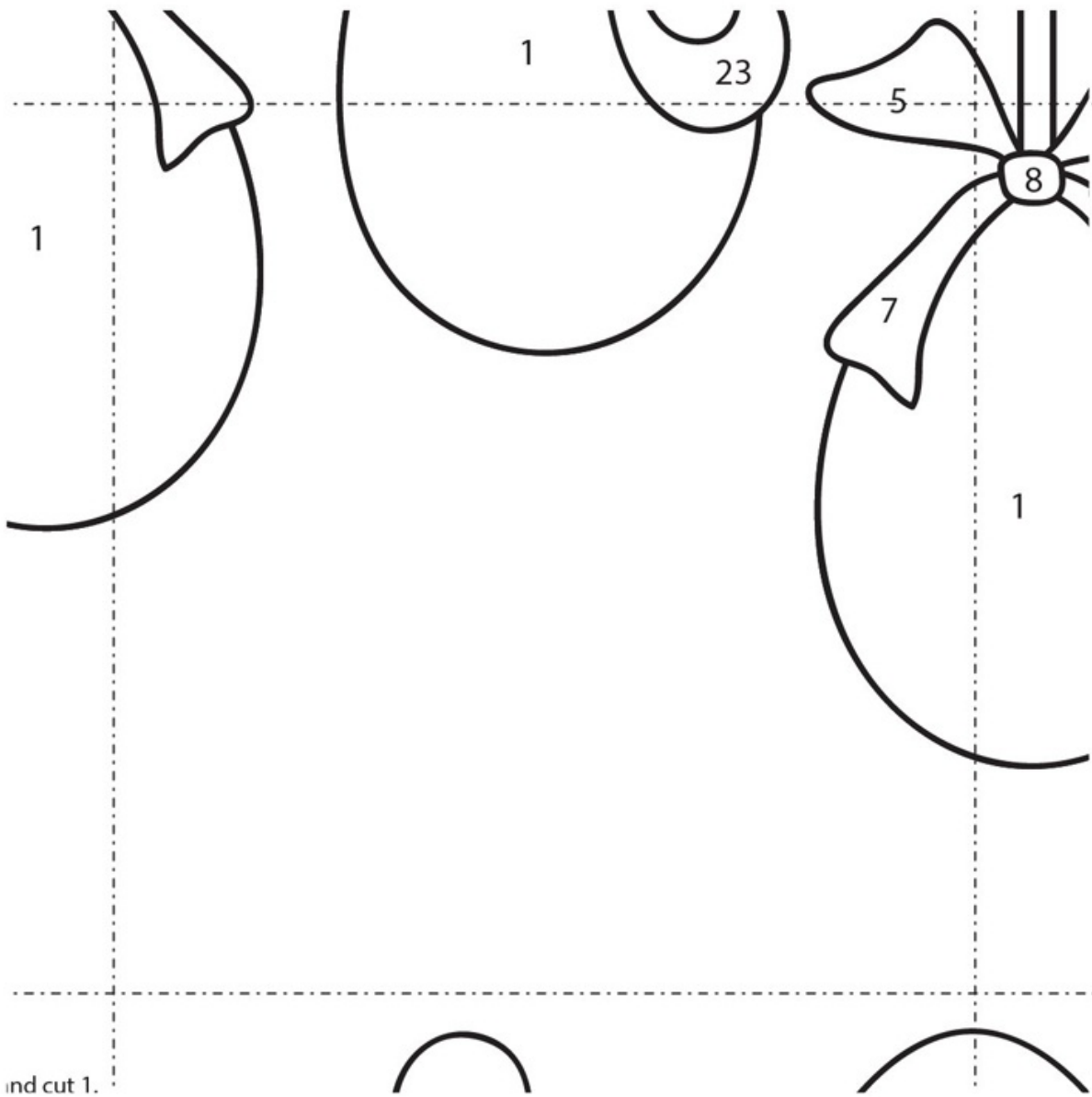
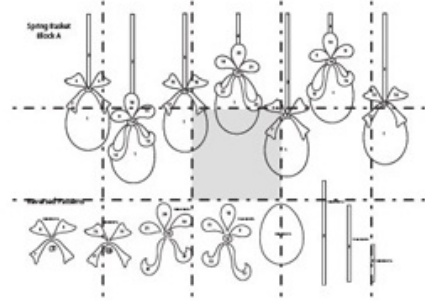
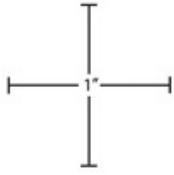

For all printable patterns or digital content: <http://tinyurl.com/11106-patterns-download>

# Spring Basket: block A

Note: Patterns are also printed in reverse for fusible appliqué.

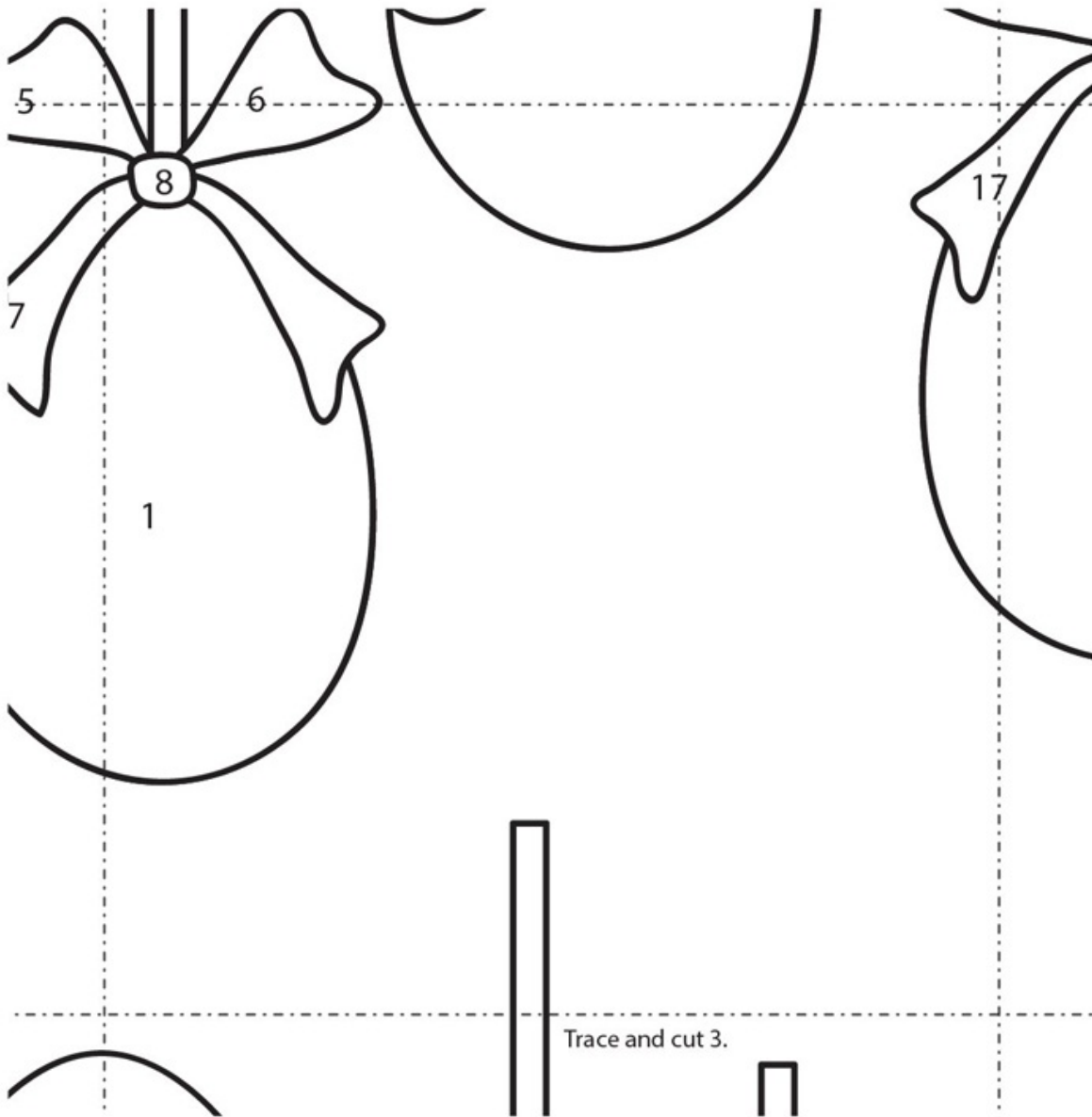
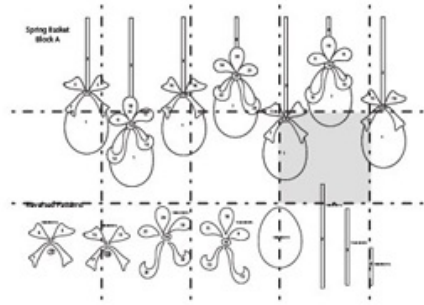
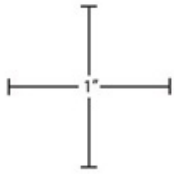

For all printable patterns or digital content: <http://tinyurl.com/11106->

patterns-download

## Spring Basket: block A

Note: Patterns are also printed in reverse for fusible appliqué.

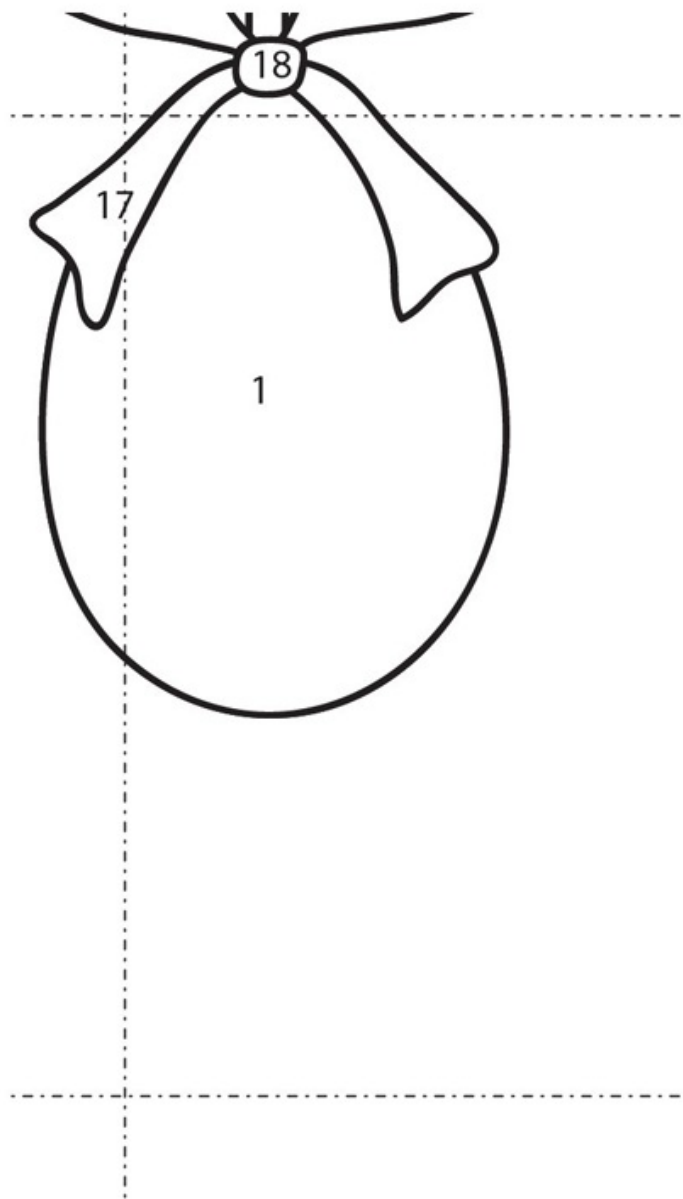
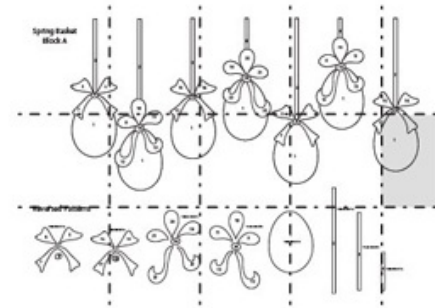
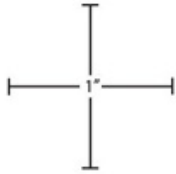



For all printable patterns or digital content: <http://tinyurl.com/11106-patterns-download>

## Spring Basket: block A

Note: Patterns are also printed in reverse for fusible appliqué.

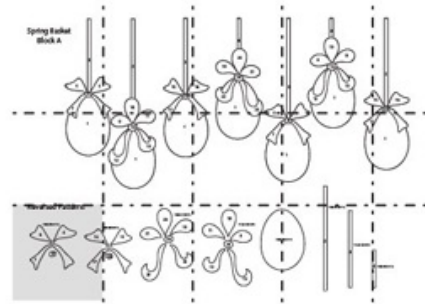
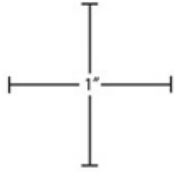

## Reversed Patterns

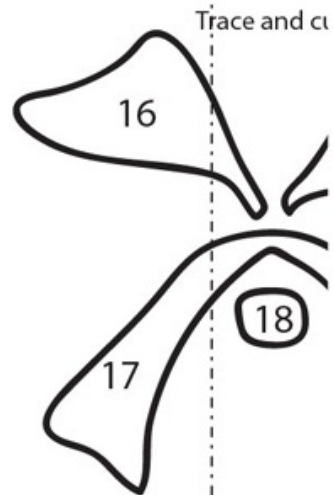
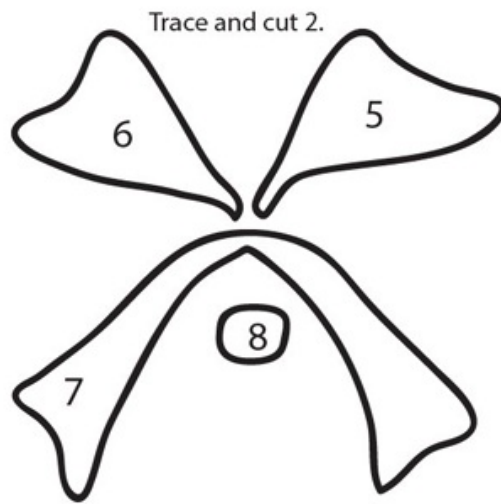

For all printable patterns or digital content: <http://tinyurl.com/11106-patterns-download>

# Spring Basket: block A

Note: Patterns are also printed in reverse for fusible appliqué.

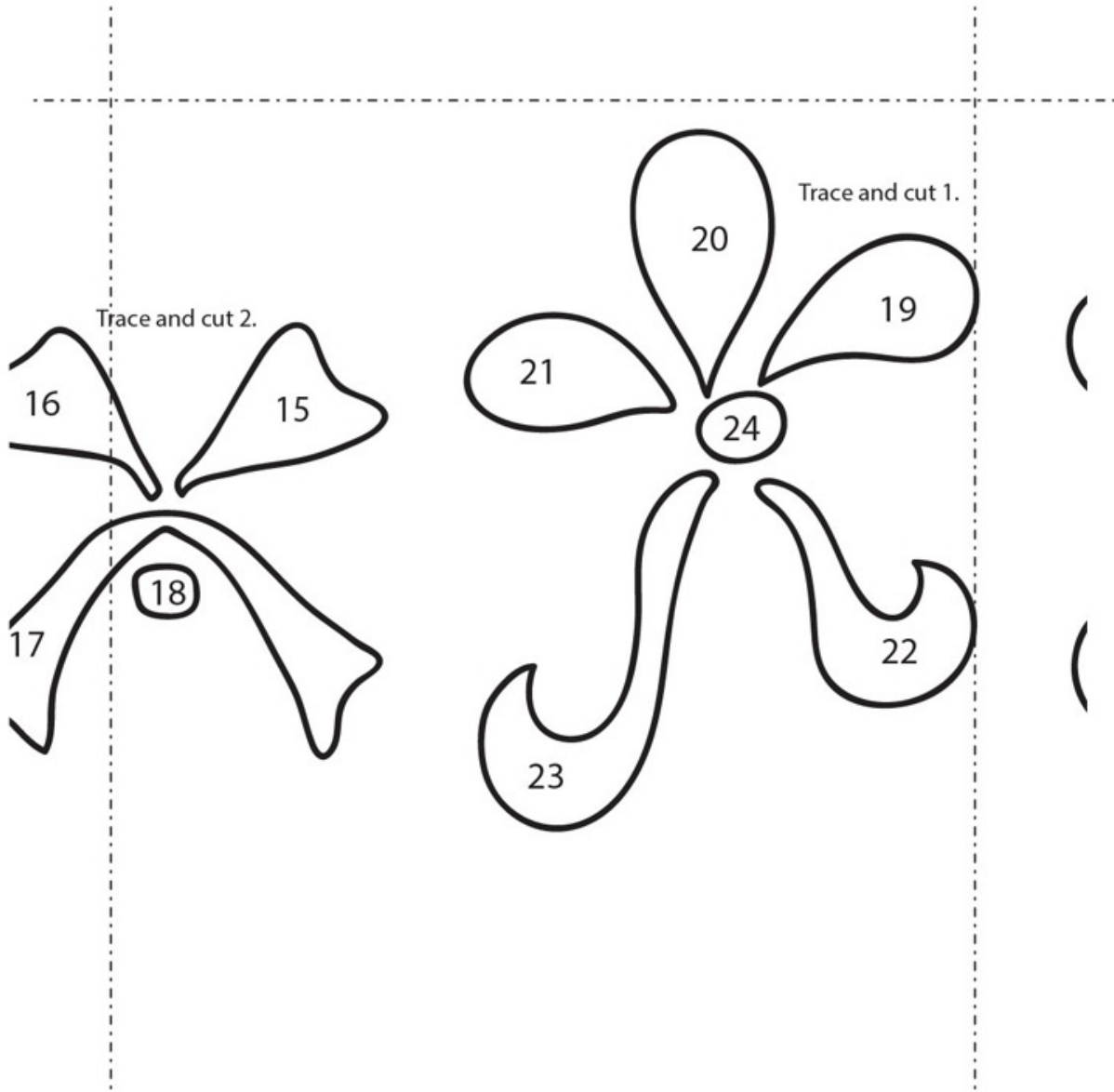
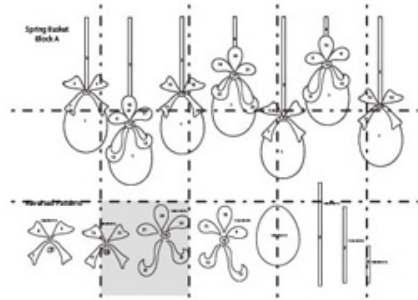
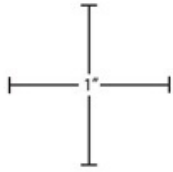

patterns-download

# Spring Basket: block A

Note: Patterns are also printed in reverse for fusible appliqué.

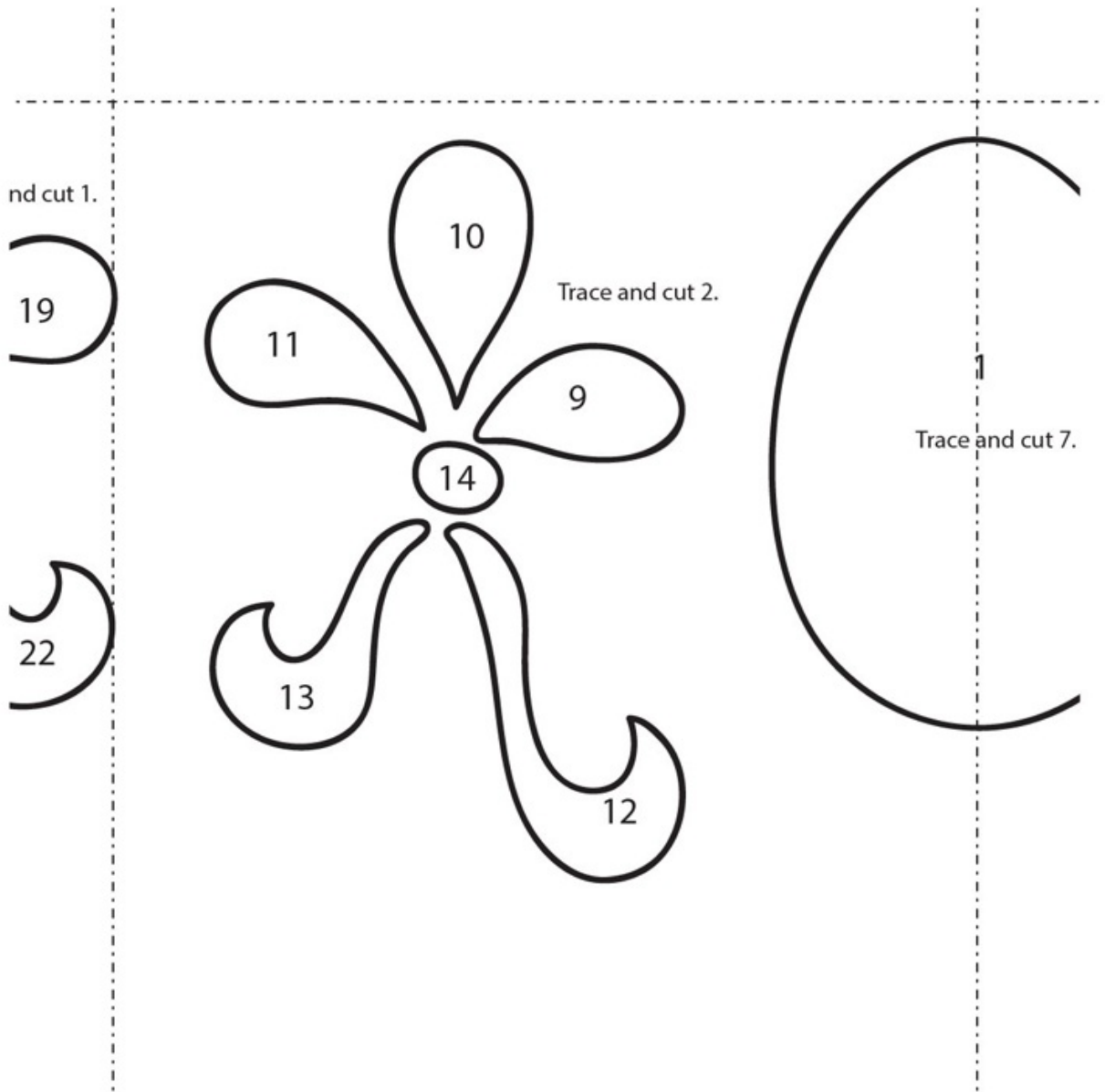
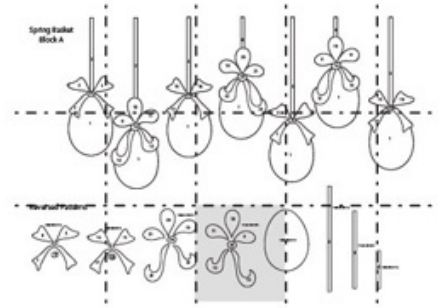
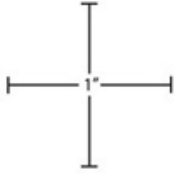

For all printable patterns or digital content: <http://tinyurl.com/11106-patterns-download>

## Spring Basket: block A

Note: Patterns are also printed in reverse for fusible appliqué.

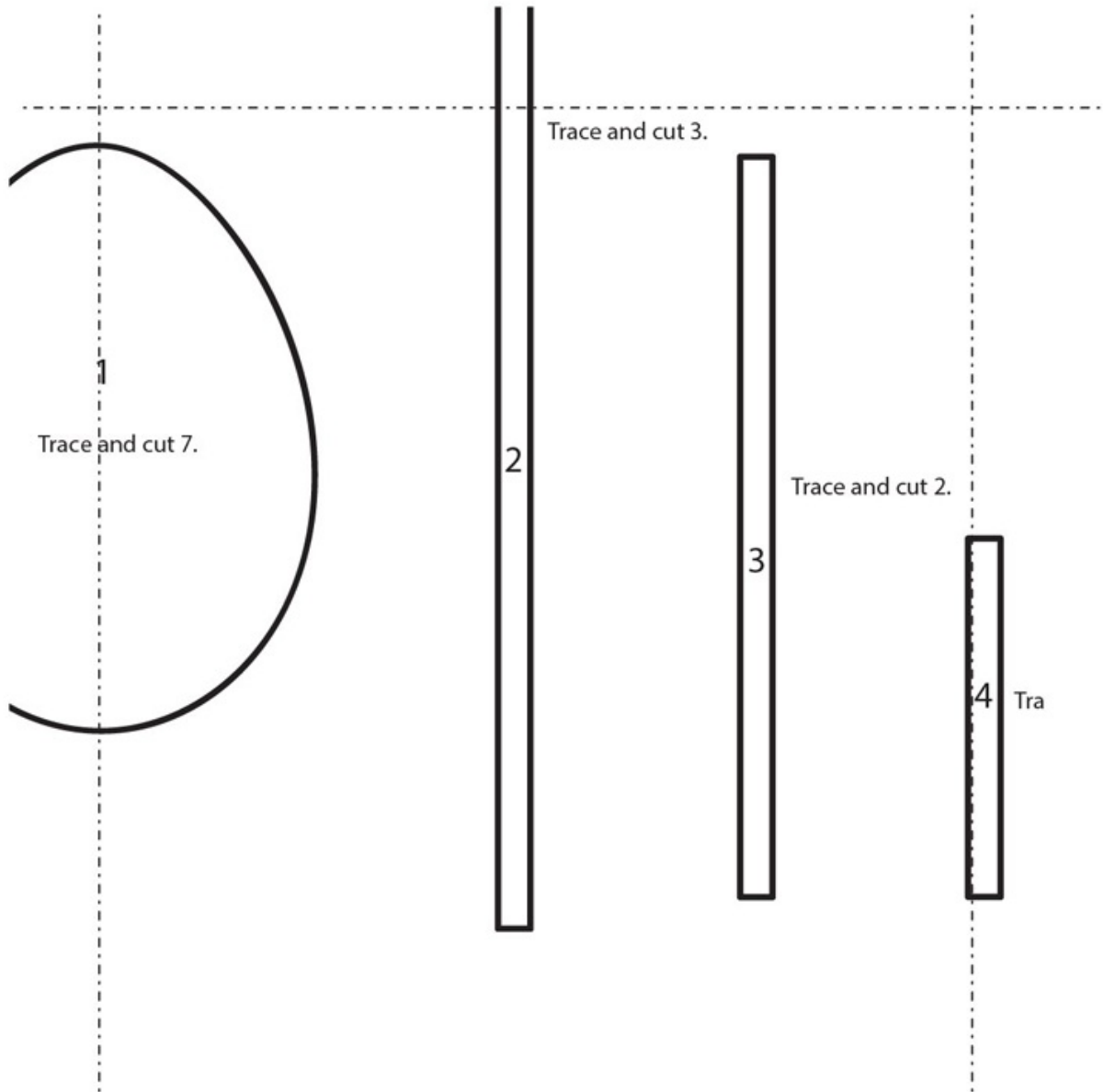
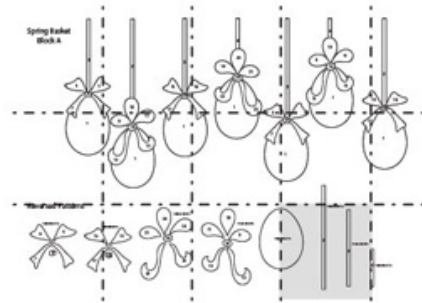
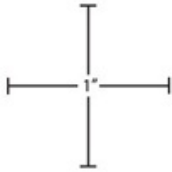

For all printable patterns or digital content: <http://tinyurl.com/11106->



patterns-download

# Spring Basket: block A

Note: Patterns are also printed in reverse for fusible appliqué.

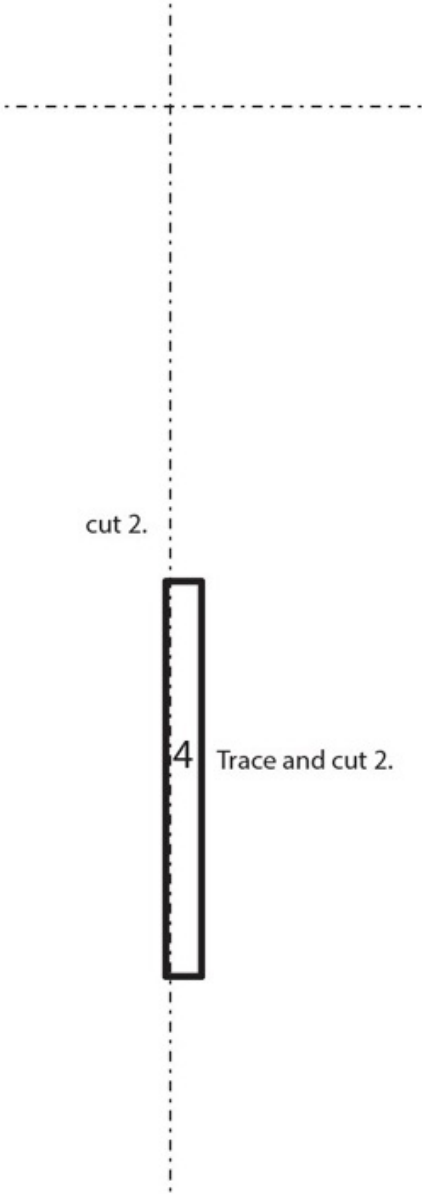
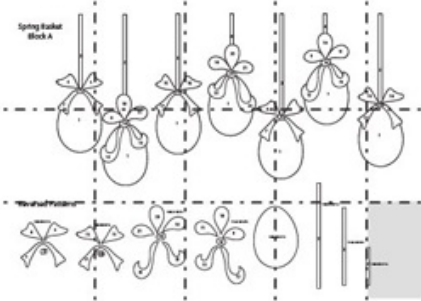
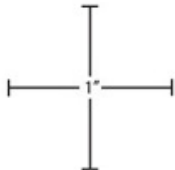

For all printable patterns or digital content: <http://tinyurl.com/11106-patterns-download>

## Spring Basket: block B

Note: Patterns are also printed in reverse for fusible appliqué.

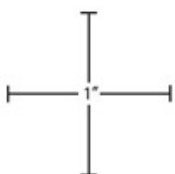

To make complete pattern, join the following pages, following the diagram for reference.

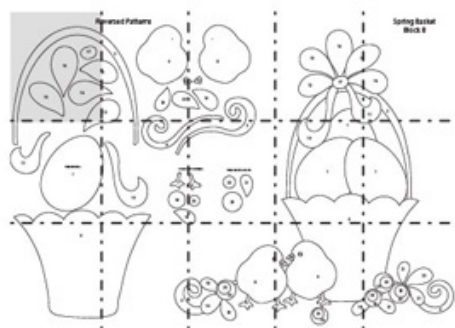

# Reve

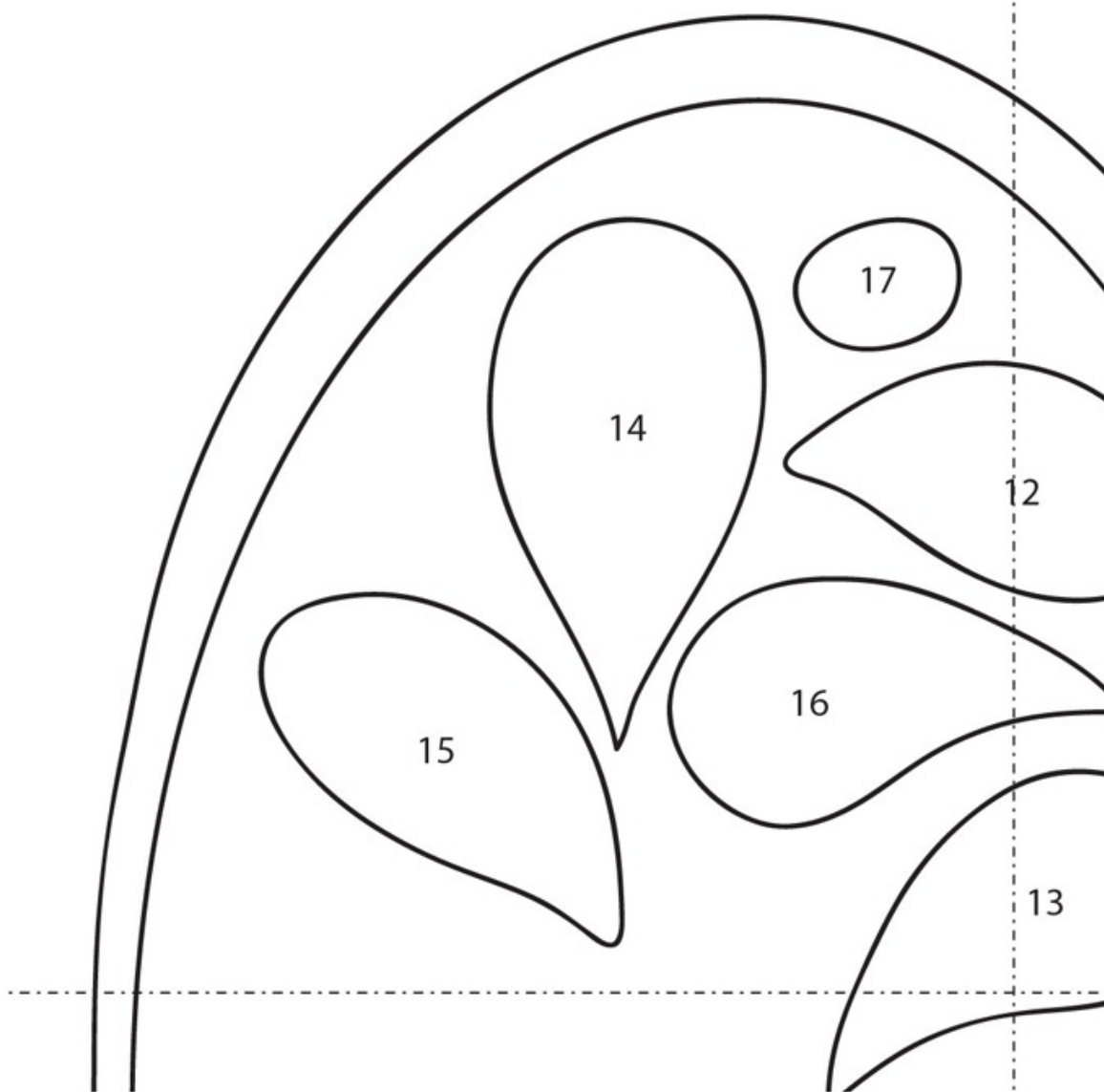

For all printable patterns or digital content: <http://tinyurl.com/11106-patterns-download>

## Spring Basket: block B

Note: Patterns are also printed in reverse for fusible appliqué.

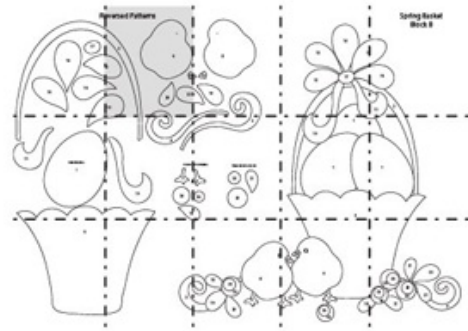
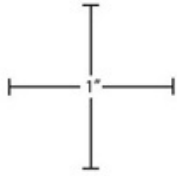

## Reversed Patterns

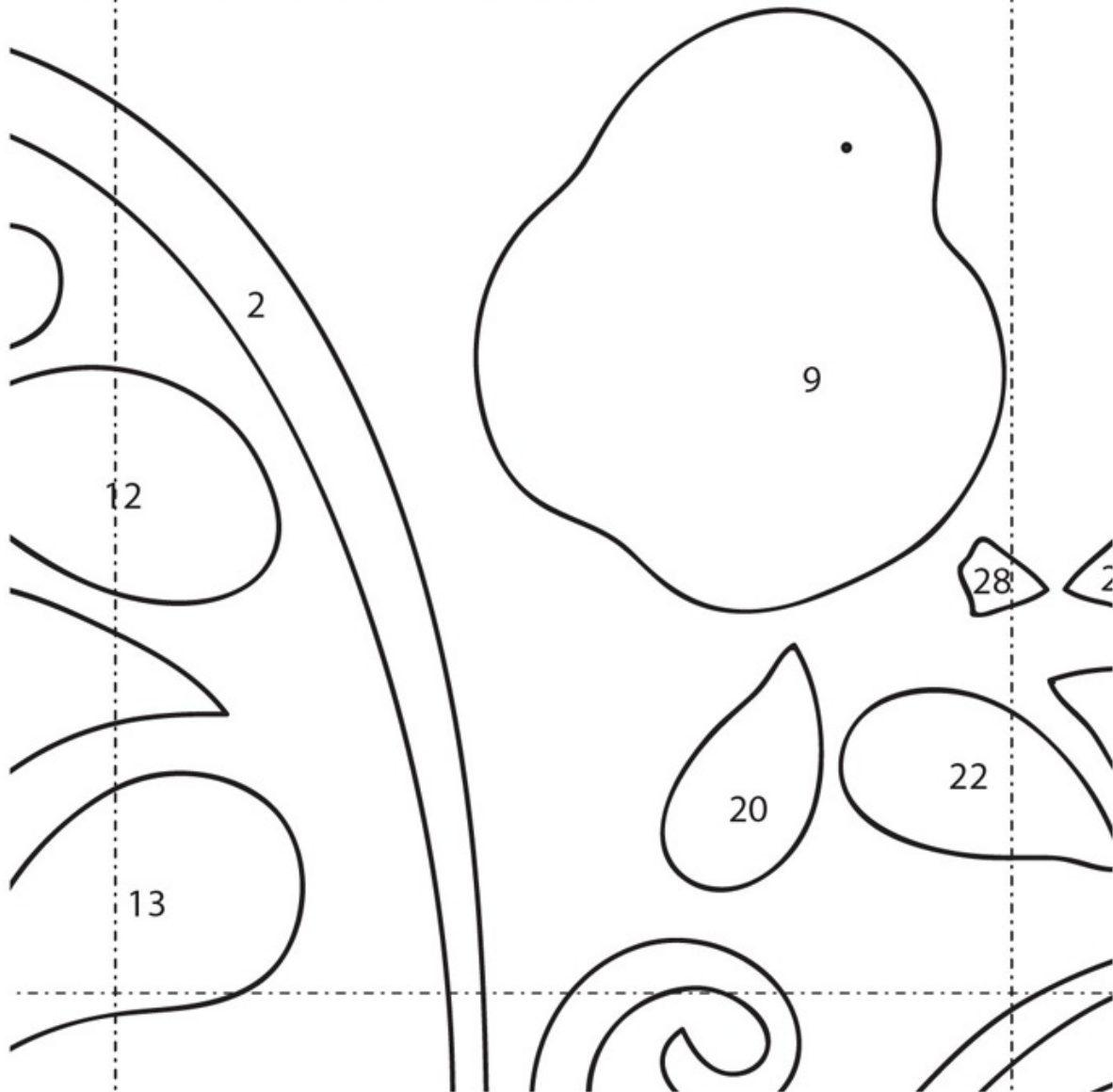

For all printable patterns or digital content: <http://tinyurl.com/11106-patterns-download>

## Spring Basket: block B

Note: Patterns are also printed in reverse for fusible appliqué.

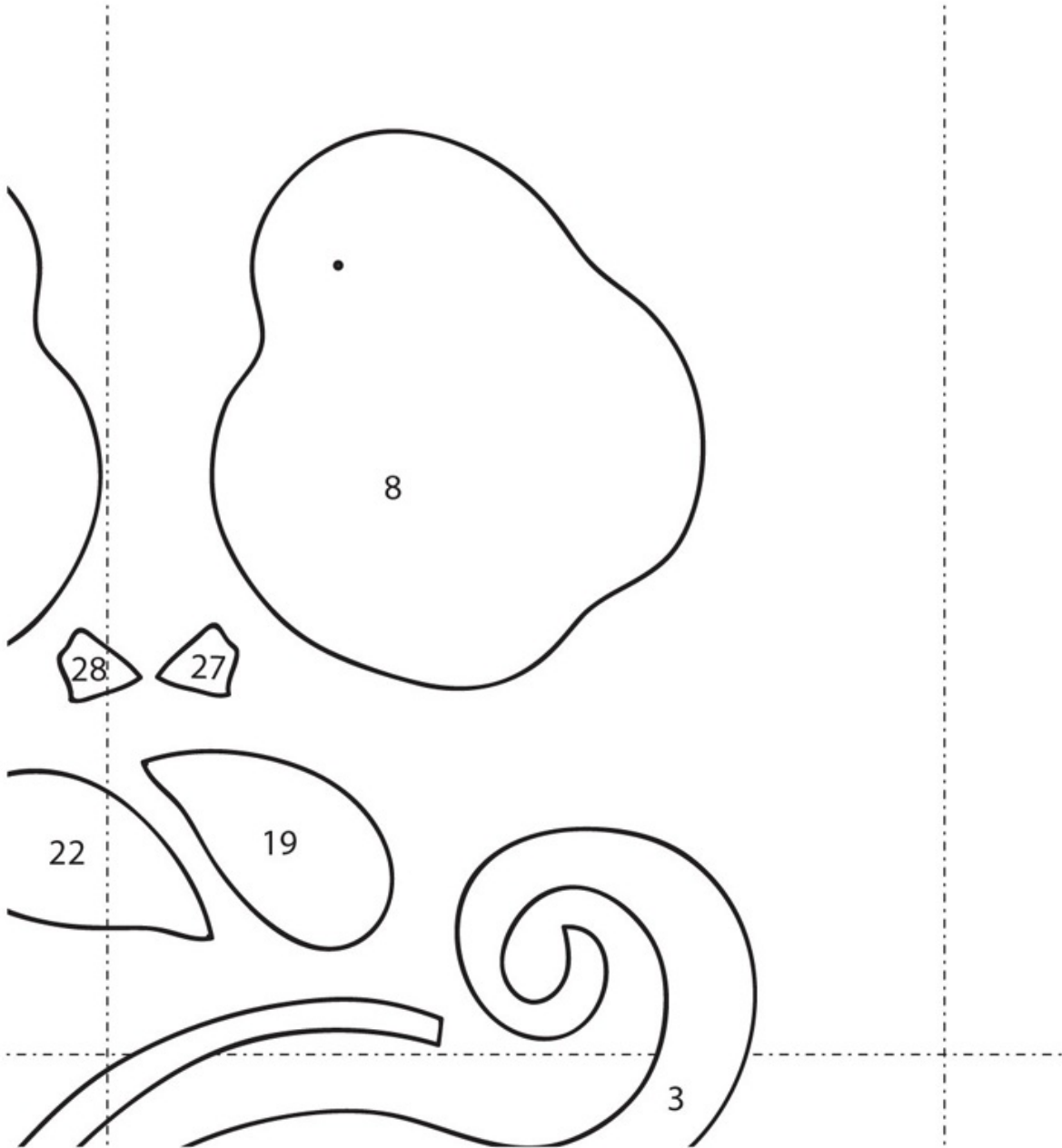
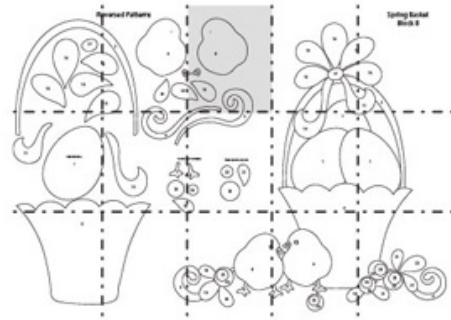
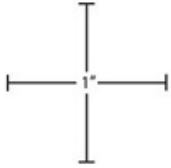

For all printable patterns or digital content: <http://tinyurl.com/11106->



**Spring Basket: block B**

*Note: Patterns are also printed in reverse for fusible appliqué.*

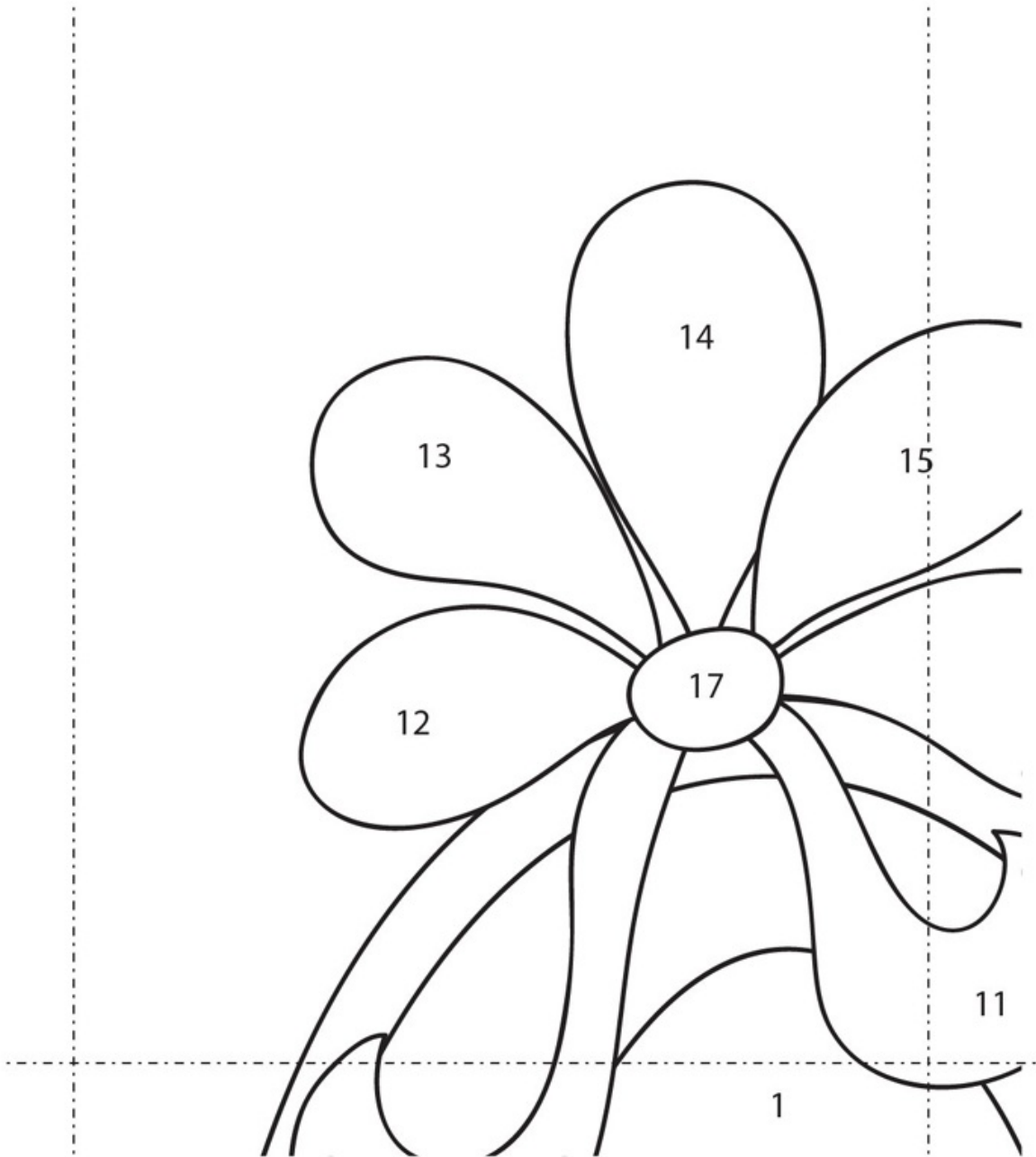
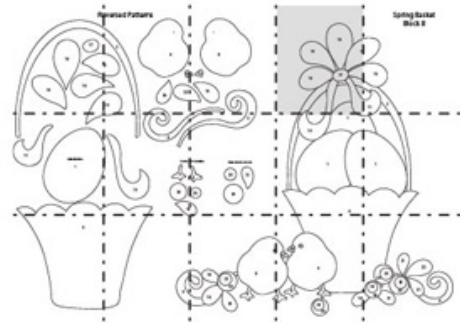
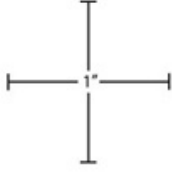

For all printable patterns or digital content: <http://tinyurl.com/11106-patterns-download>

## Spring Basket: block B

Note: Patterns are also printed in reverse for fusible appliqué.

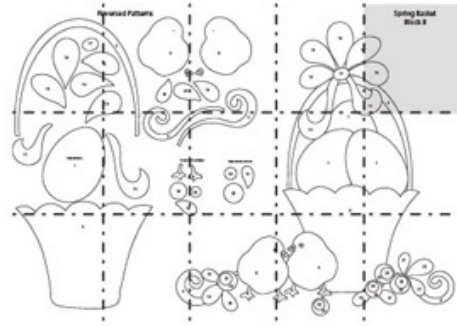
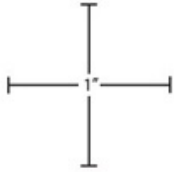

# Spring Basket Block B

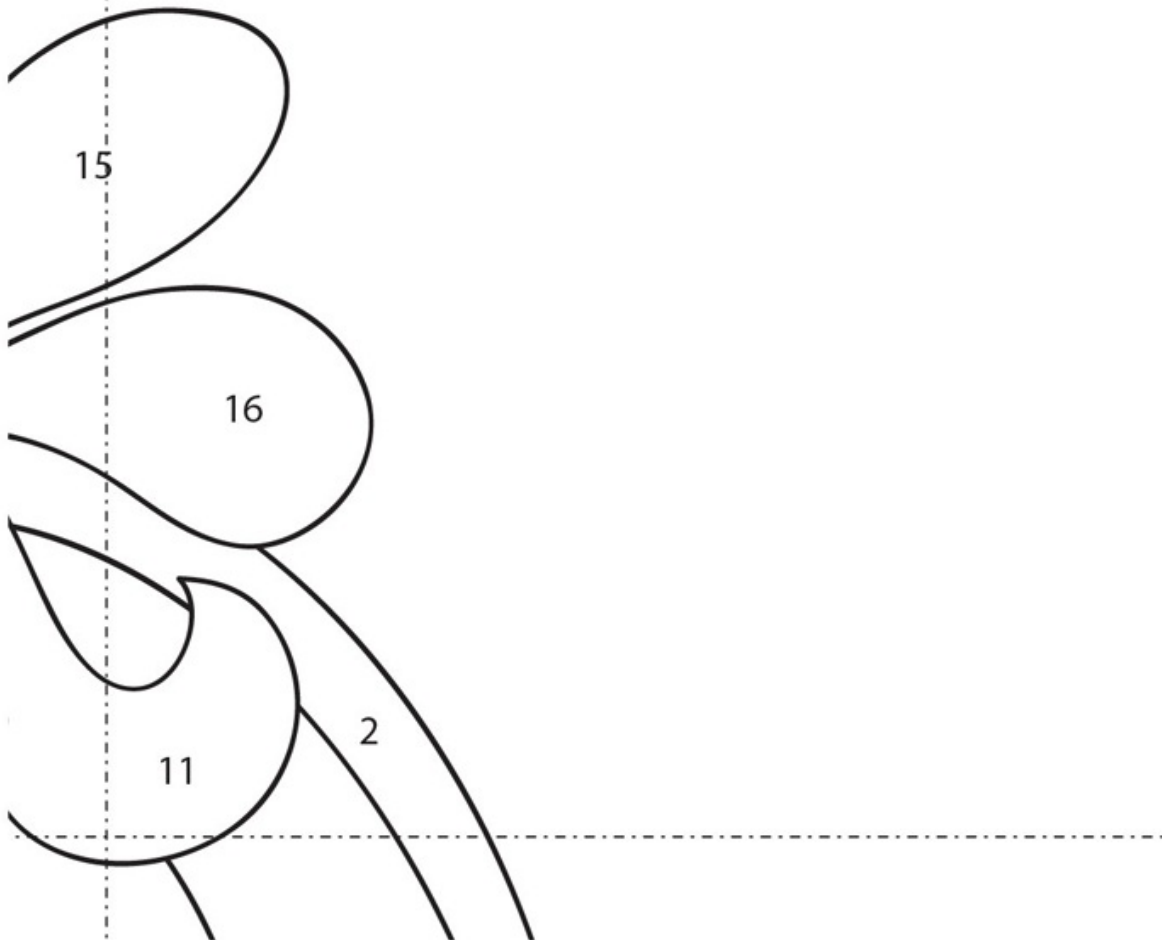

For all printable patterns or digital content: <http://tinyurl.com/11106-patterns-download>

# Spring Basket: block B

Note: Patterns are also printed in reverse for fusible appliqué.

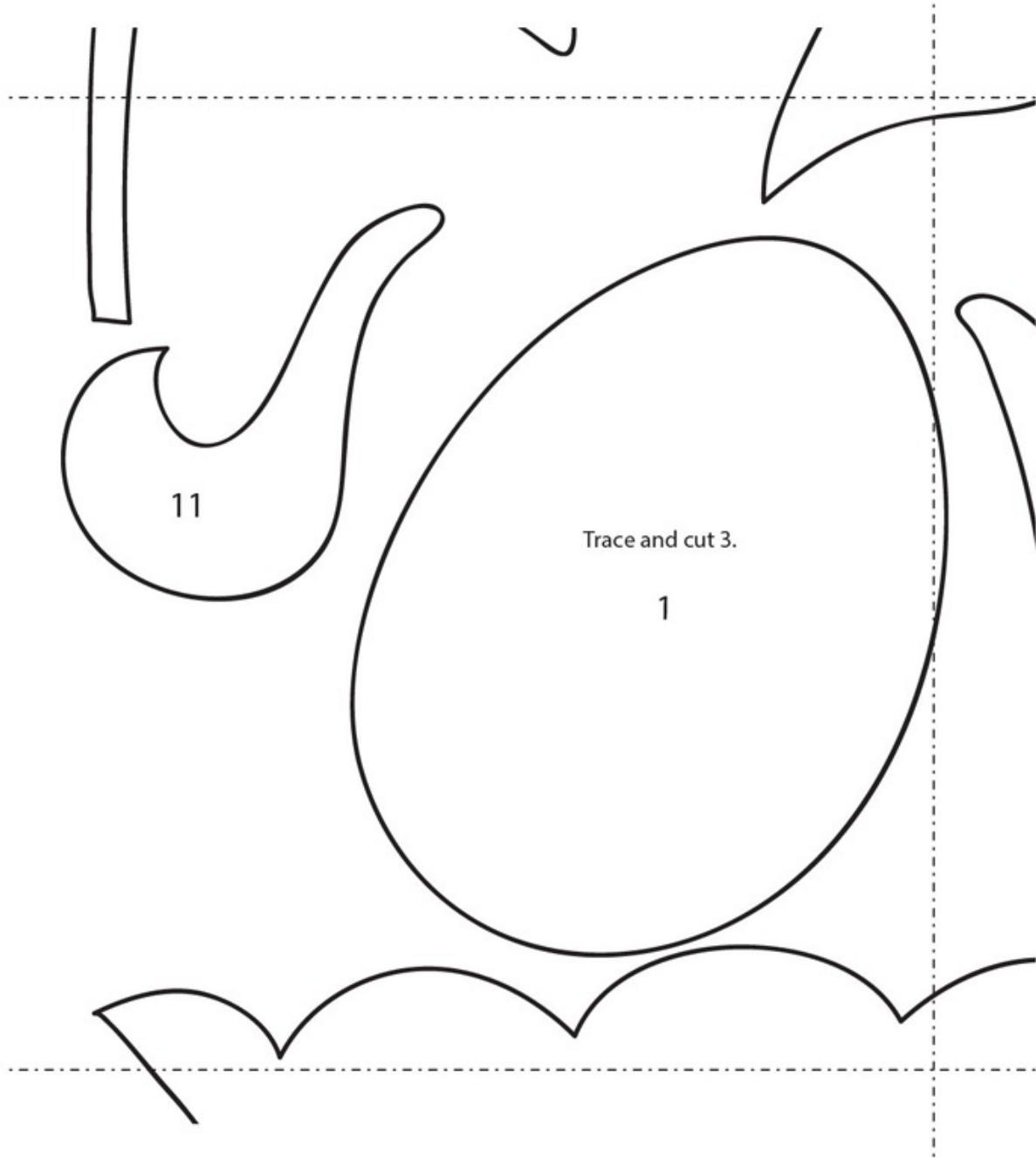
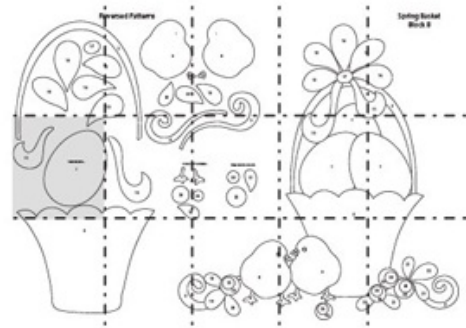
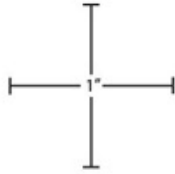

For all printable patterns or digital content: <http://tinyurl.com/11106-patterns-download>

# Spring Basket: block B

Note: Patterns are also printed in reverse for fusible appliqué.

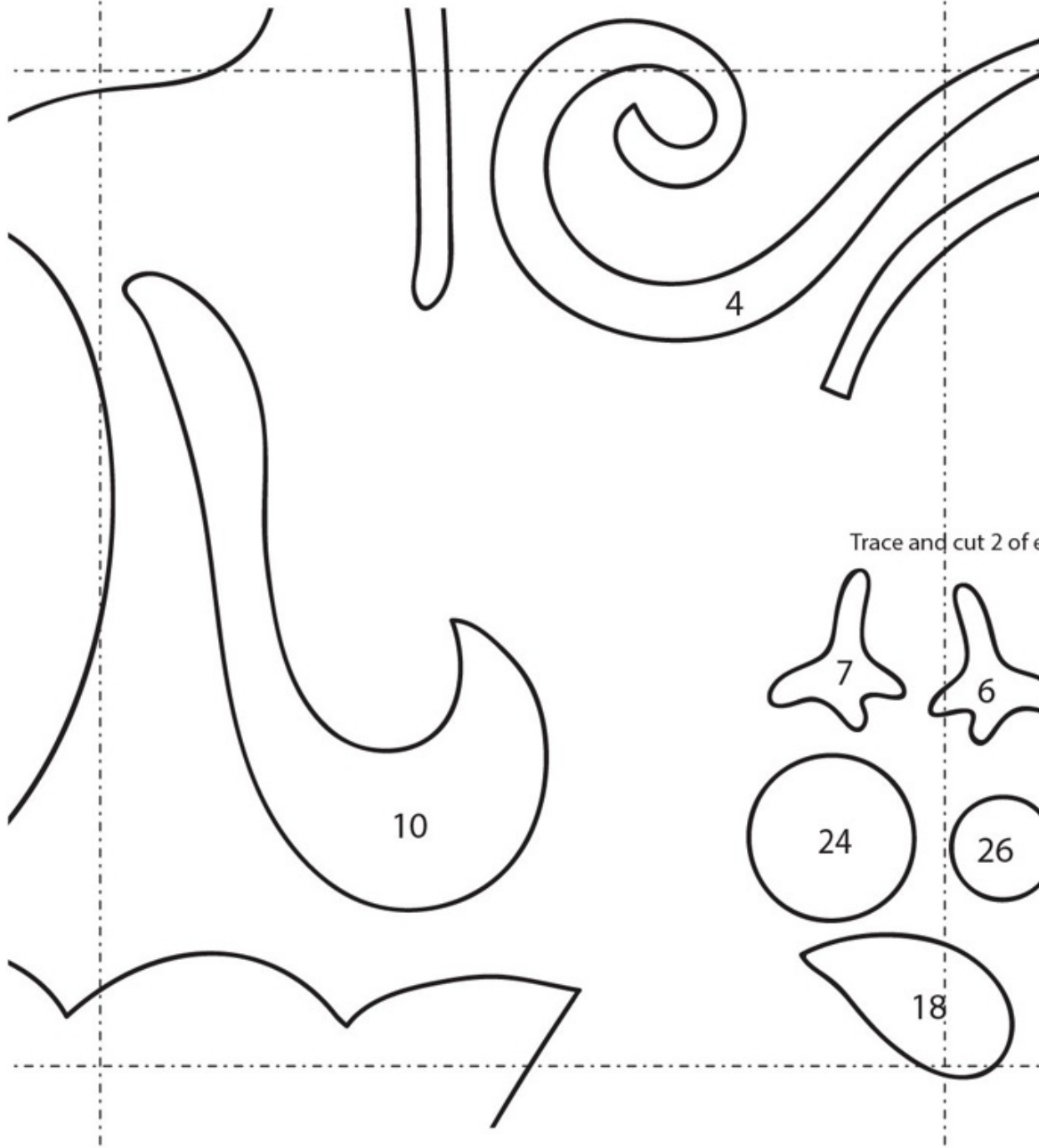
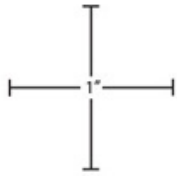
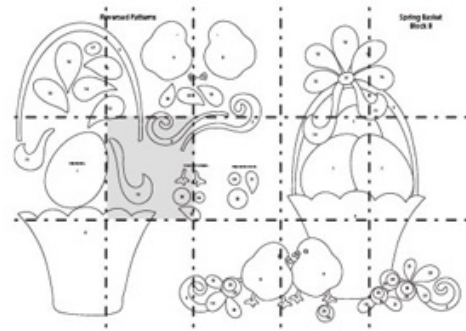

Trace and cut 2 of e

For all printable patterns or digital content: <http://tinyurl.com/11106-patterns-download>



# Spring Basket: block B

Note: Patterns are also printed in reverse for fusible appliqué.

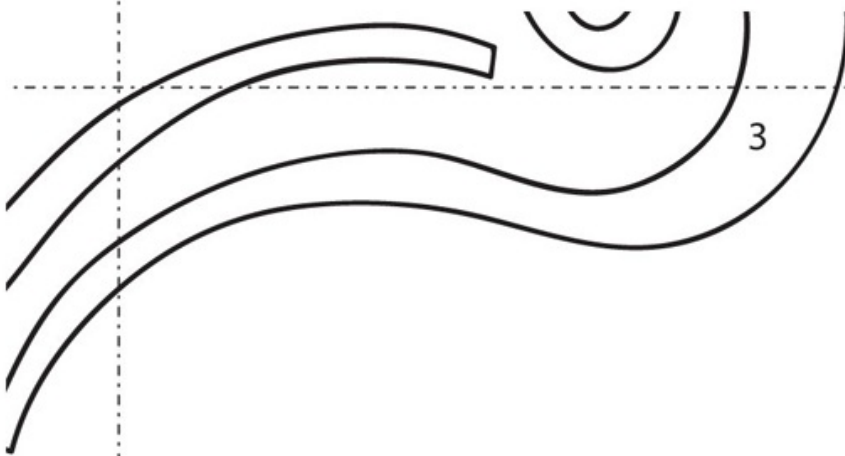
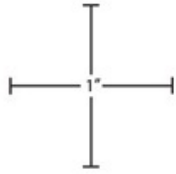
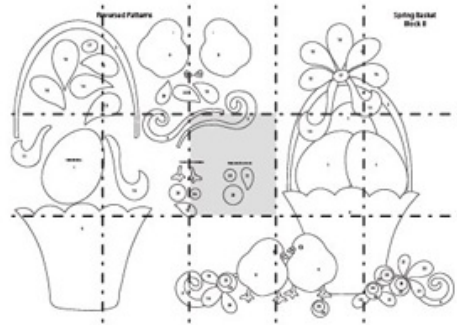

Trace and cut 2 of each.

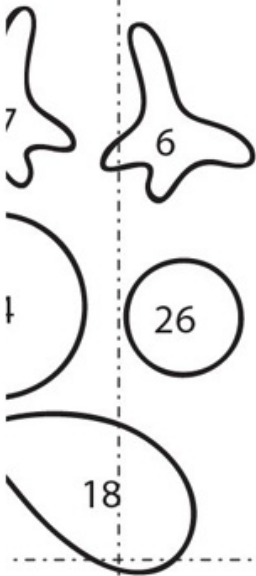

Trace and cut 3 of each.

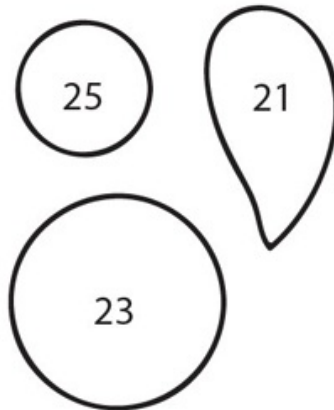

**Spring Basket: block B**

*Note: Patterns are also printed in reverse for fusible appliqué.*

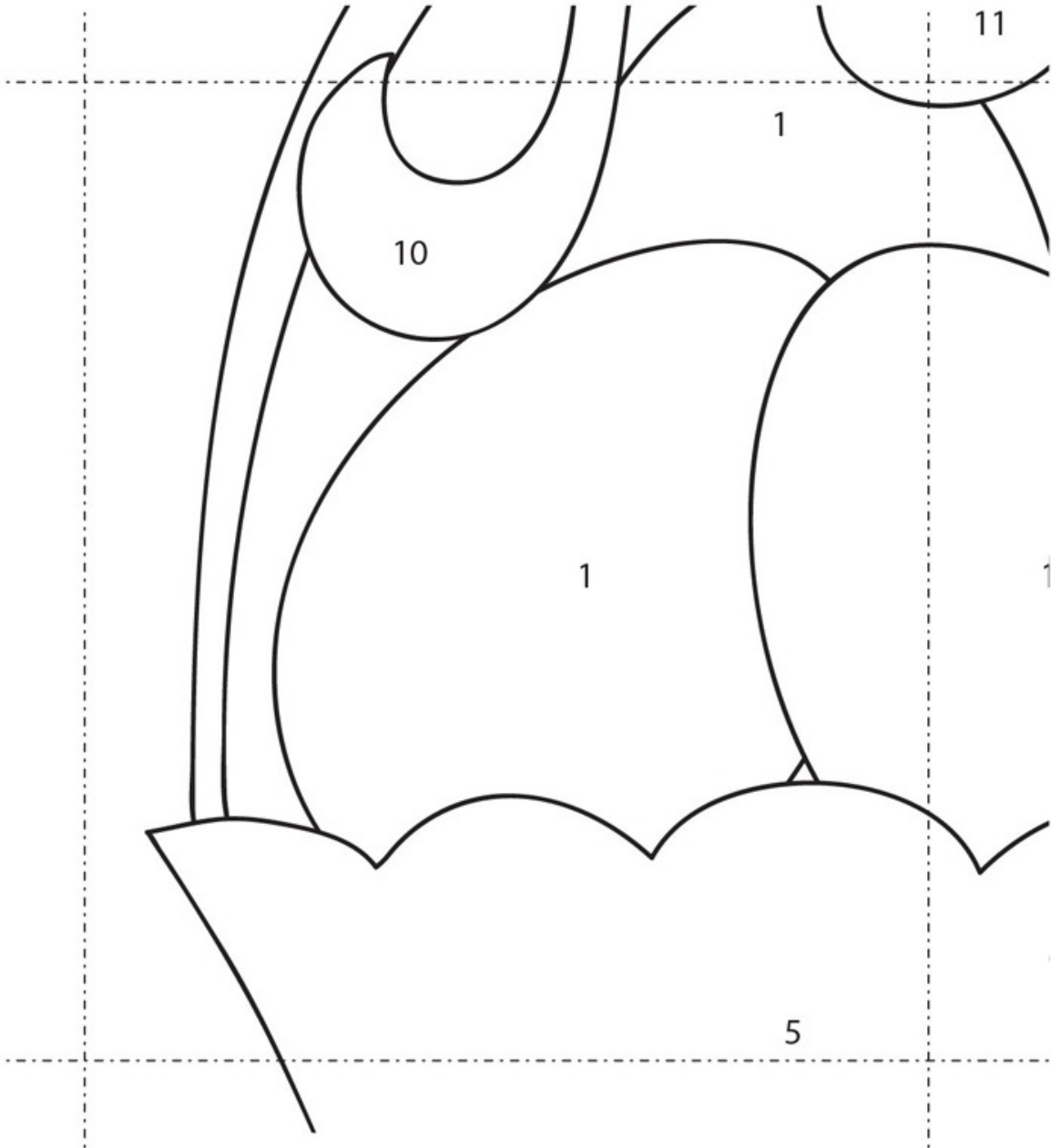
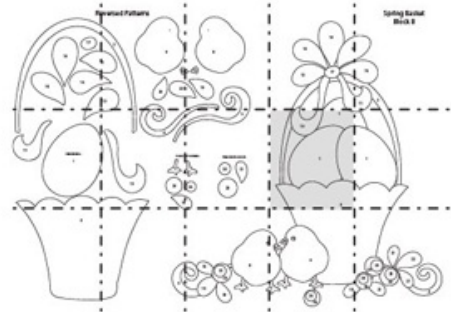
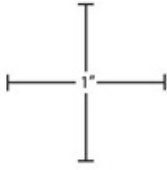

For all printable patterns or digital content: <http://tinyurl.com/11106-patterns-download>

## Spring Basket: block B

Note: Patterns are also printed in reverse for fusible appliqué.

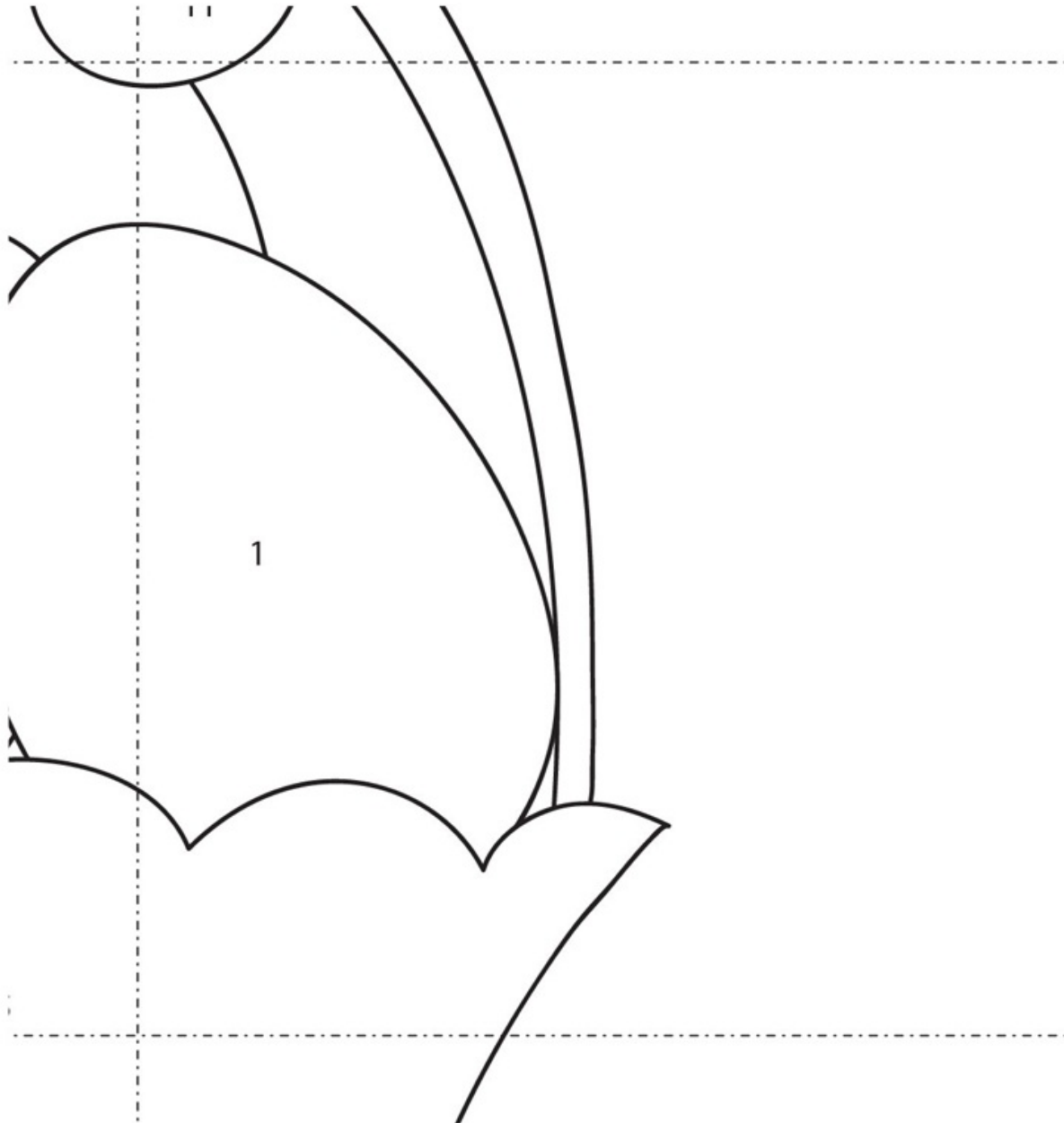
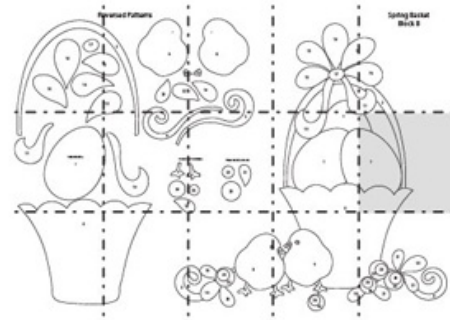
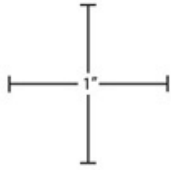

For all printable patterns or digital content: <http://tinyurl.com/11106->

patterns-download

# Spring Basket: block B

Note: Patterns are also printed in reverse for fusible appliqué.

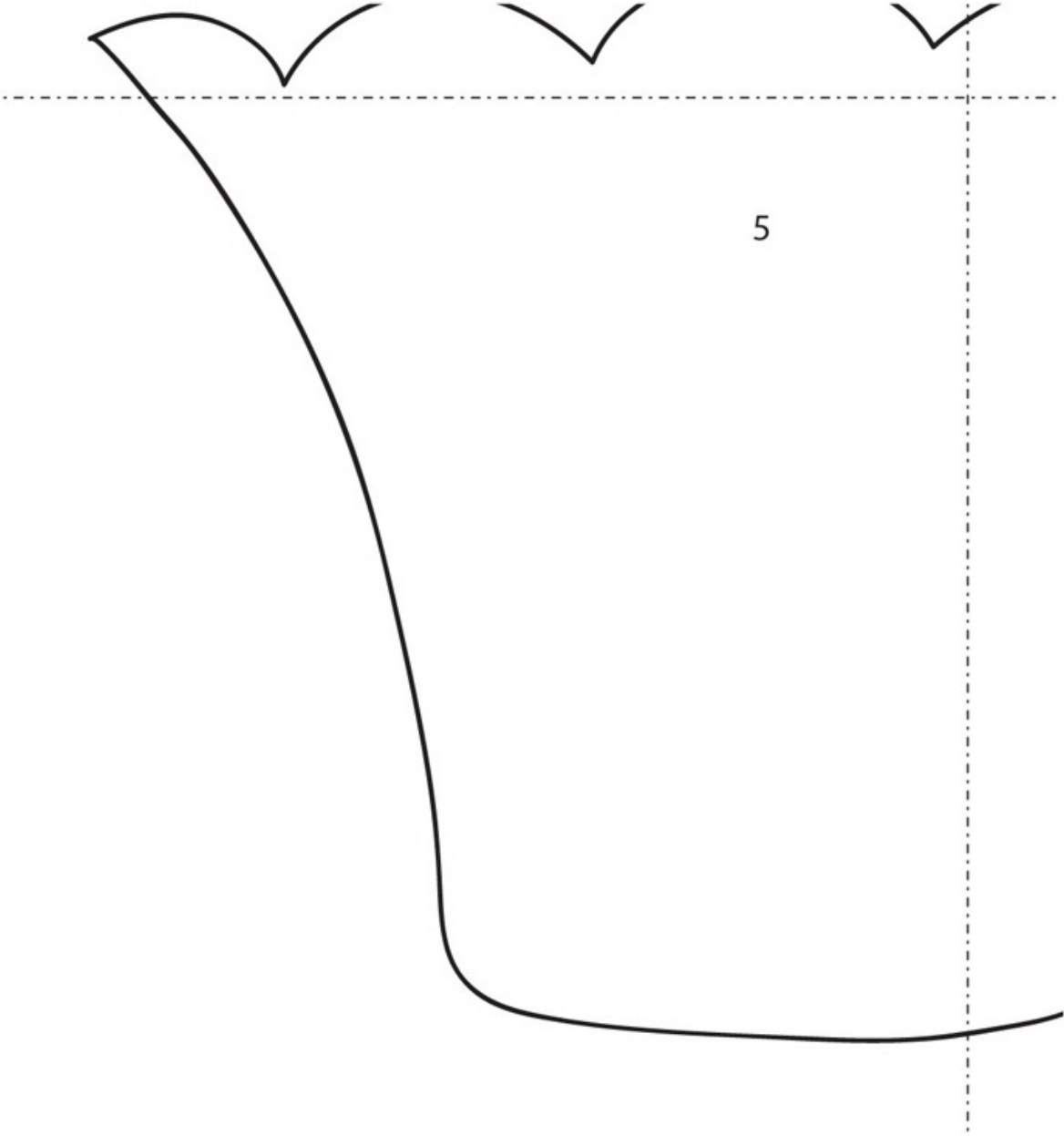
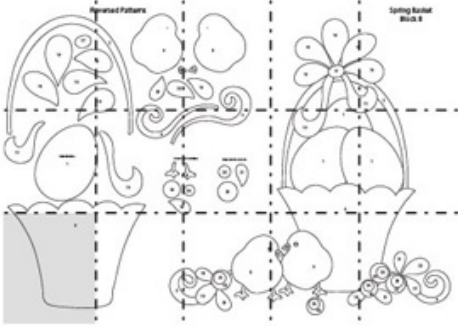
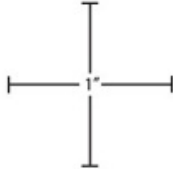

For all printable patterns or digital content: <http://tinyurl.com/11106-patterns-download>

# Spring Basket: block B

Note: Patterns are also printed in reverse for fusible appliqué.

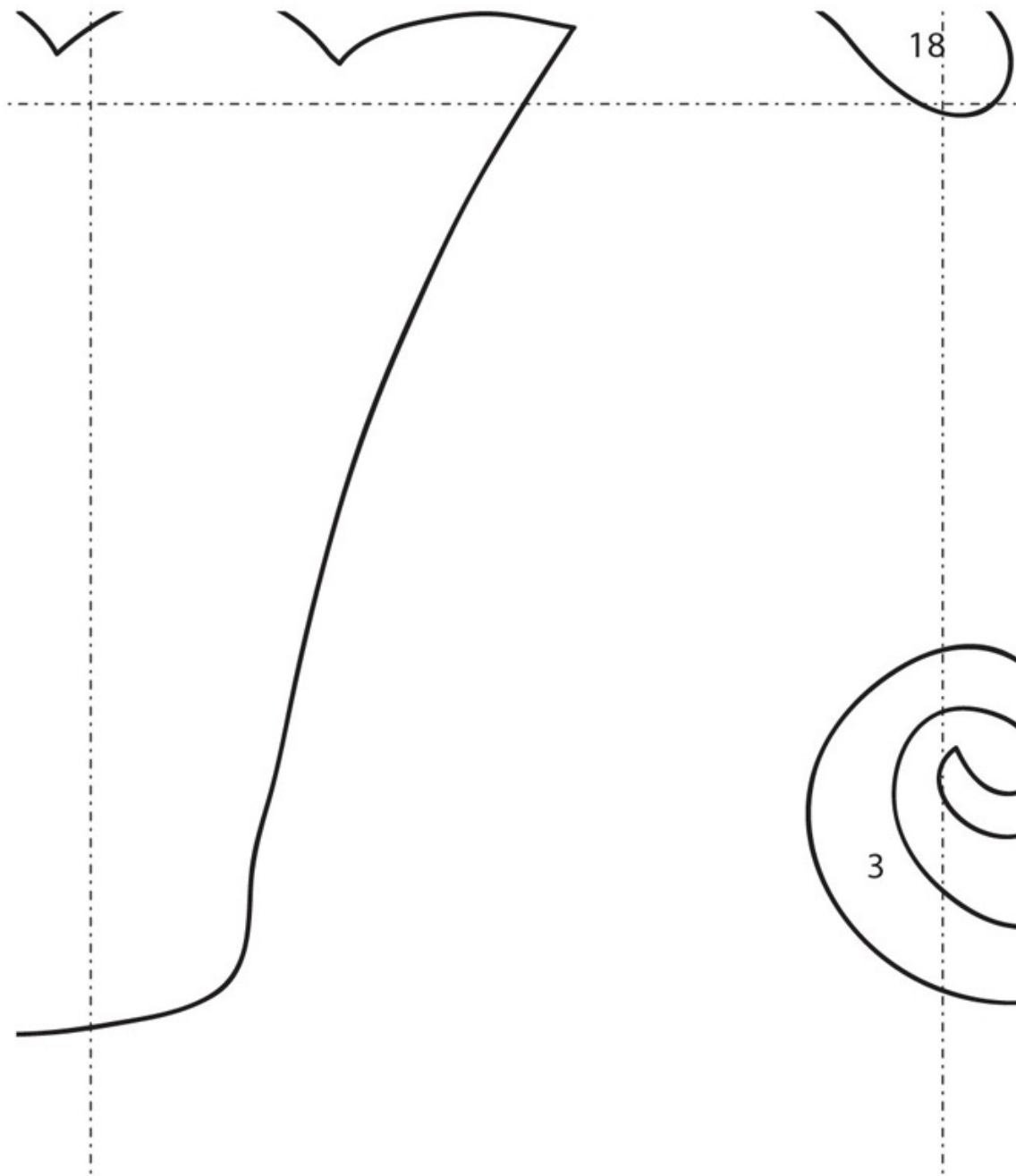
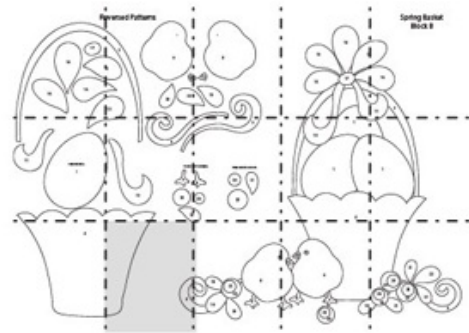
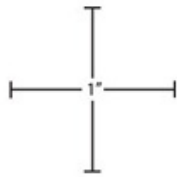



For all printable patterns or digital content: <http://tinyurl.com/11106-patterns-download>

# Spring Basket: block B

Note: Patterns are also printed in reverse for fusible appliqué.

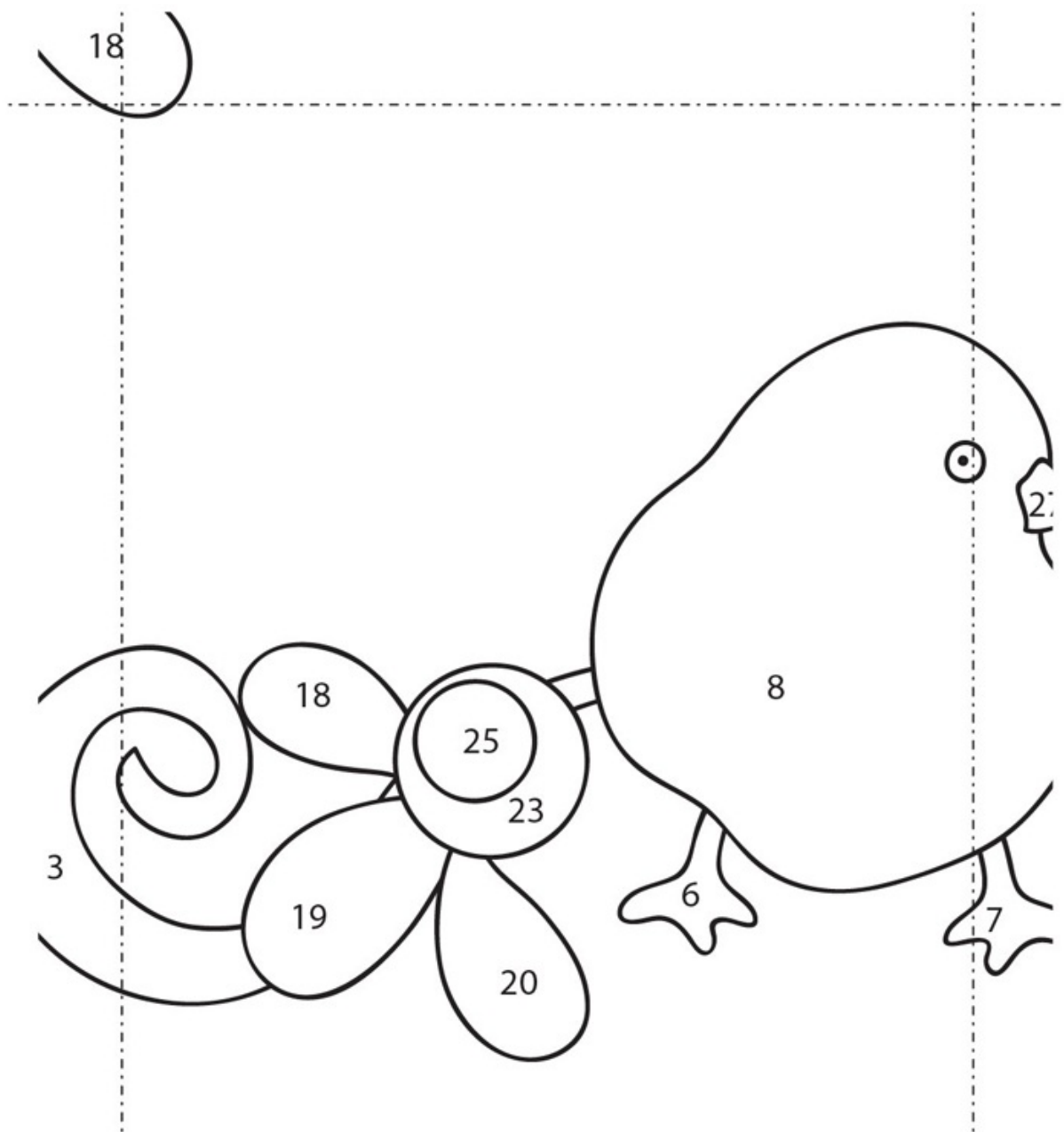
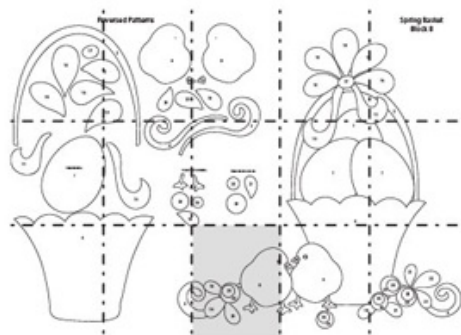
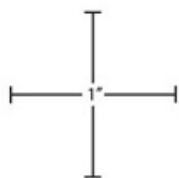

For all printable patterns or digital content: <http://tinyurl.com/11106-patterns-download>

# Spring Basket: block B

Note: Patterns are also printed in reverse for fusible appliqué.

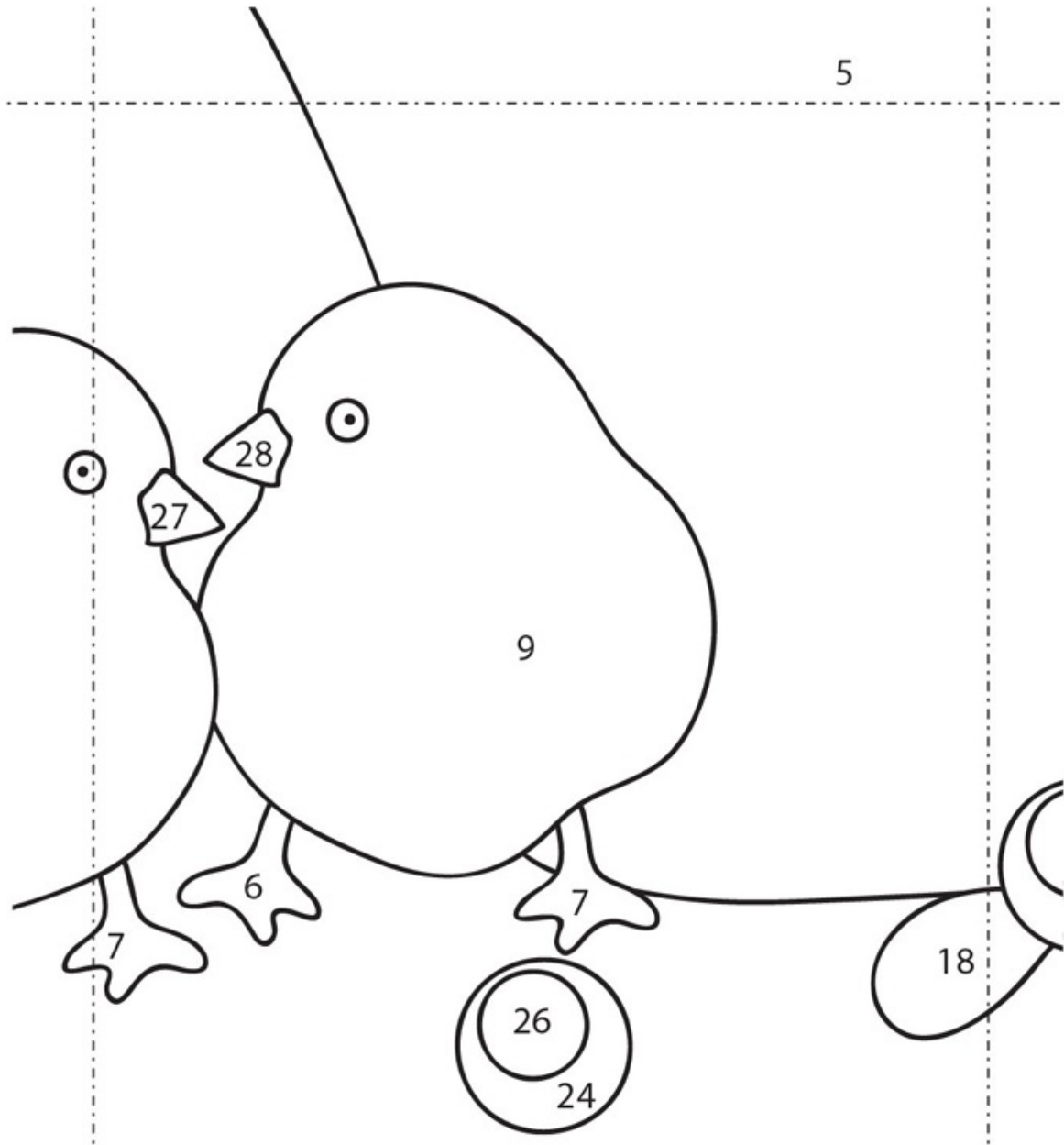
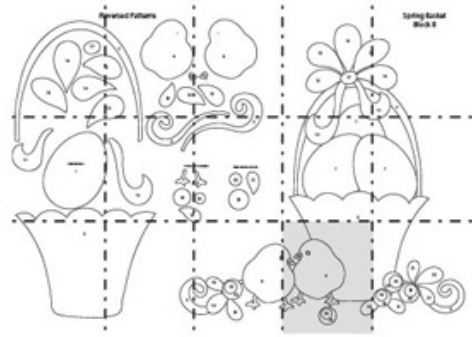
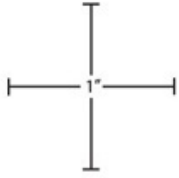

For all printable patterns or digital content: <http://tinyurl.com/11106-patterns-download>

# Spring Basket: block B

Note: Patterns are also printed in reverse for fusible appliqué.

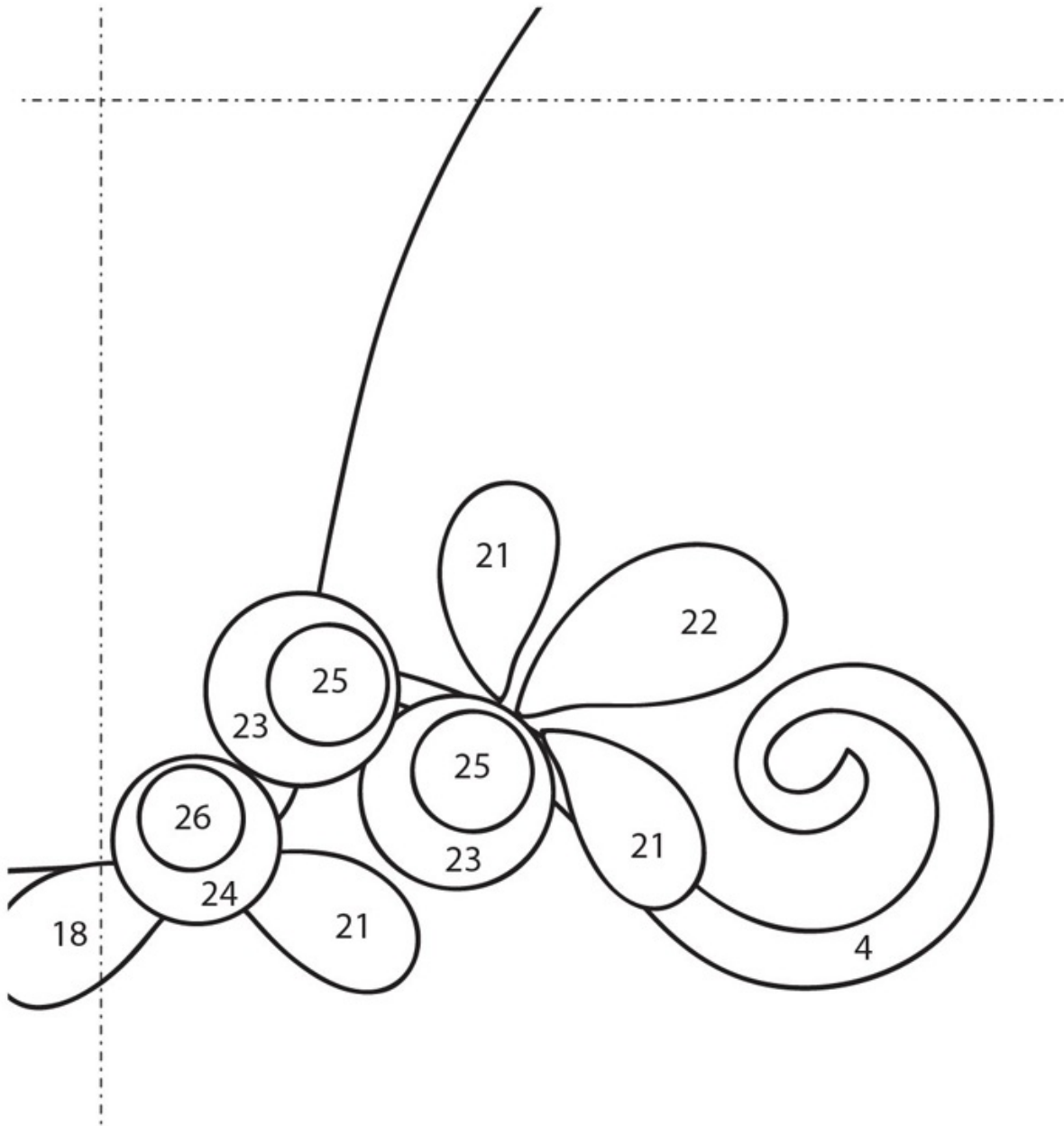
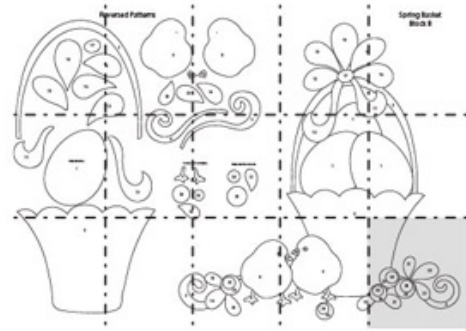
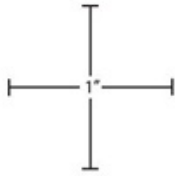

For all printable patterns or digital content: <http://tinyurl.com/11106-patterns-download>

## Spring Basket: block C

Note: Patterns are also printed in reverse for fusible appliqué.

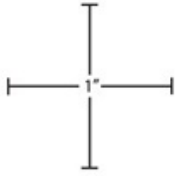

To make complete pattern, join the following pages, following the diagram for reference.

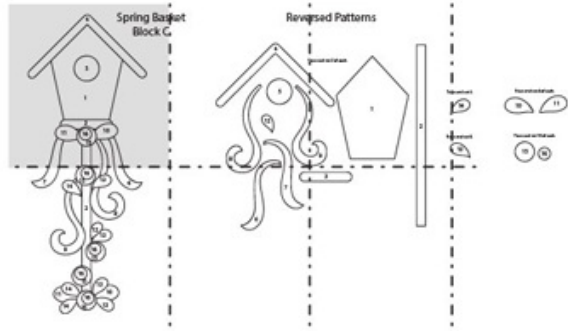

## Spring Basket Block C

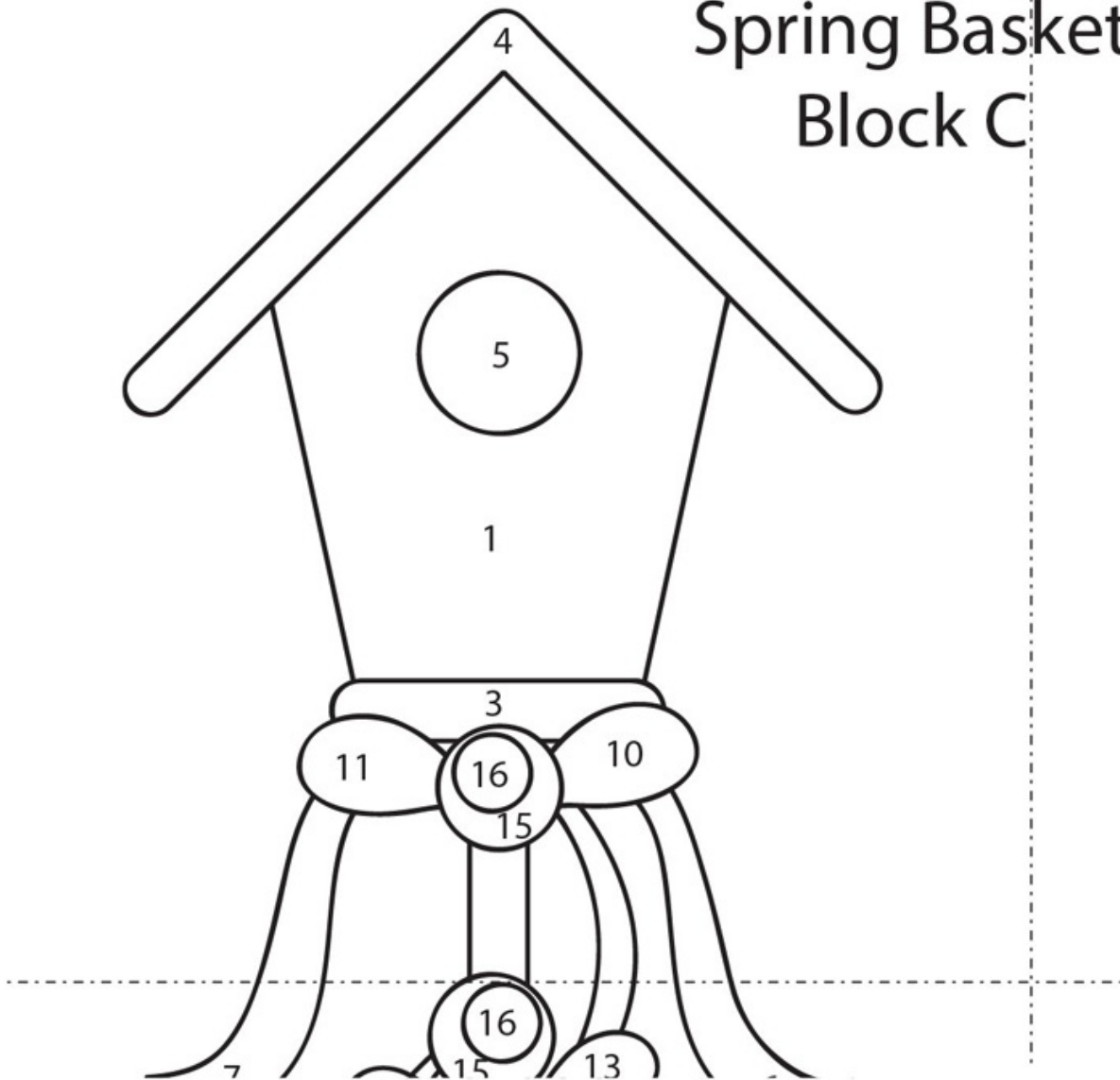



For all printable patterns or digital content: <http://tinyurl.com/11106-patterns-download>

# Spring Basket: block C

Note: Patterns are also printed in reverse for fusible appliqué.

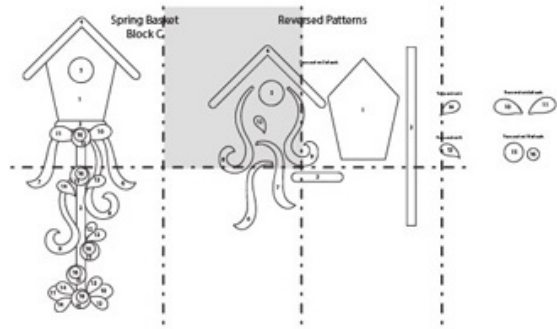
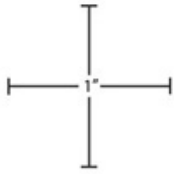

Basket  
k C

Reverse



For all printable patterns or digital content: <http://tinyurl.com/11106-patterns-download>

### Spring Basket: block C

Note: Patterns are also printed in reverse for fusible appliqué.

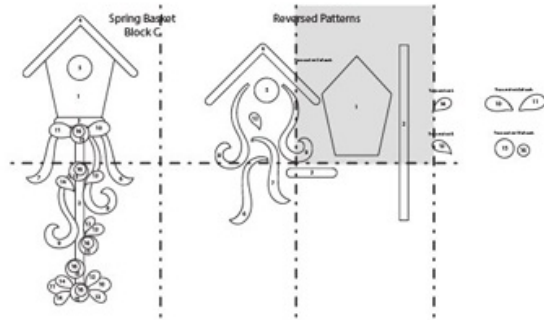
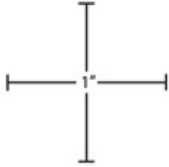

## eversed Patterns

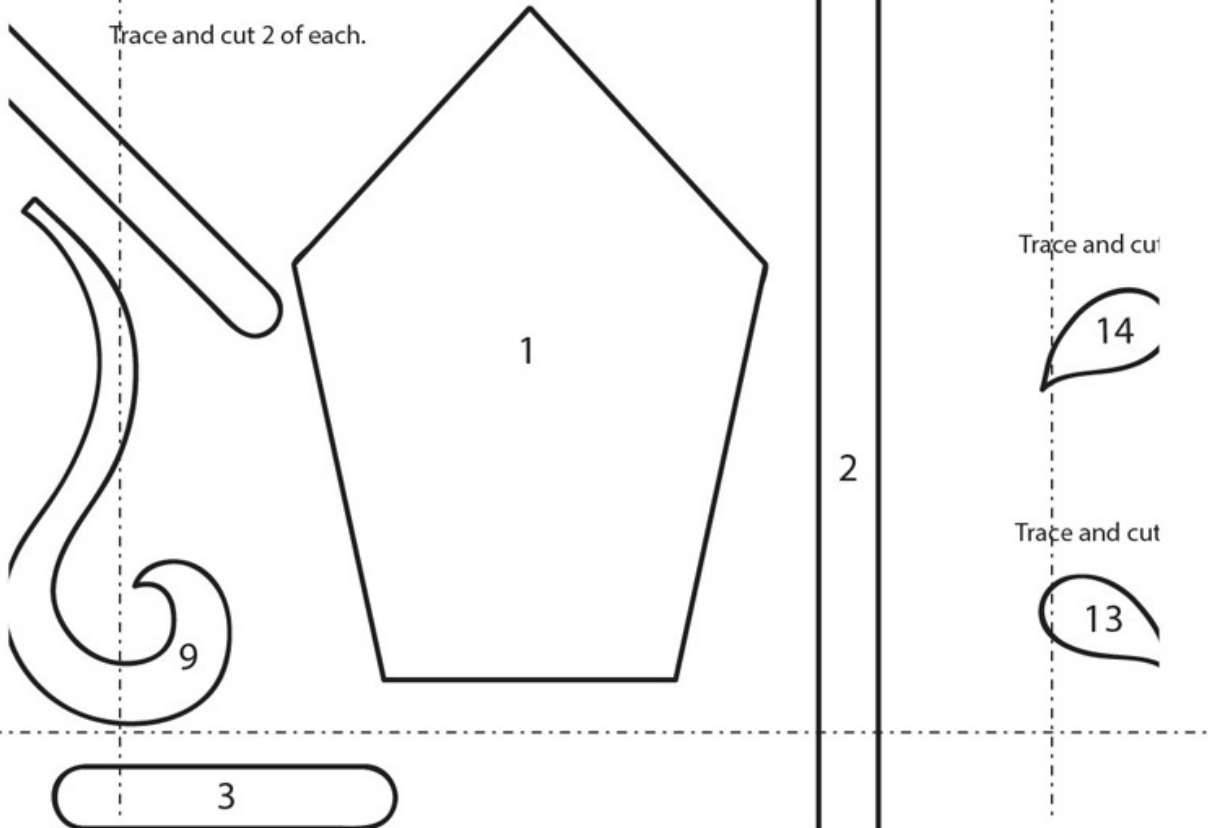

For all printable patterns or digital content: <http://tinyurl.com/11106-patterns-download>

### Spring Basket: block C

Note: Patterns are also printed in reverse for fusible appliqué.

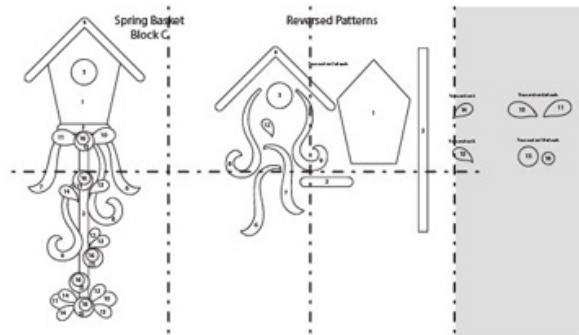
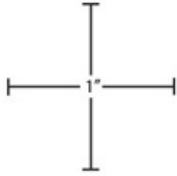

Trace and cut 6.

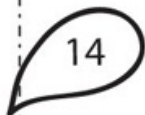

Trace and cut 4 of each.



Trace and cut 8.

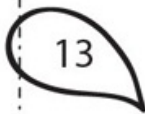

Trace and cut 10 of each.

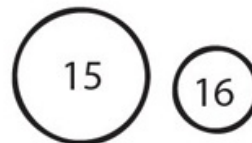

For all printable patterns or digital content: <http://tinyurl.com/11106-patterns-download>

# Spring Basket: block C

Note: Patterns are also printed in reverse for fusible appliqué.

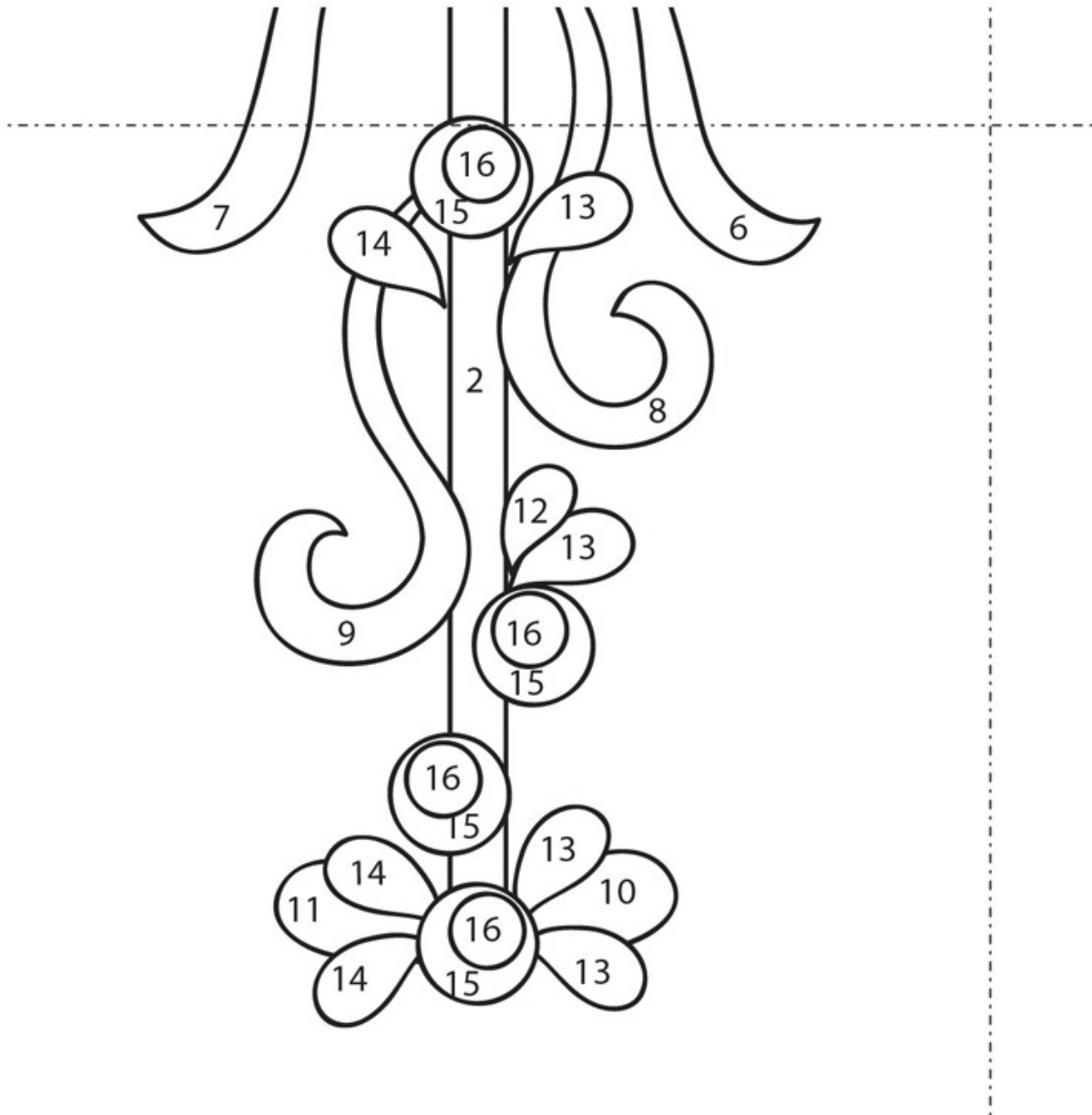
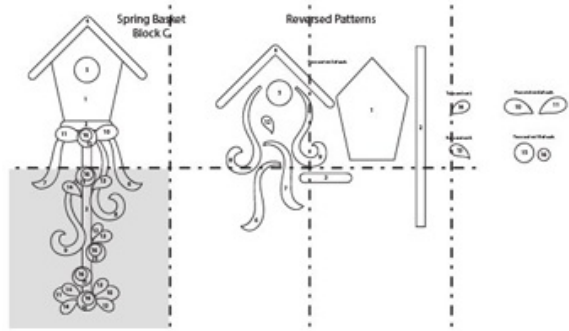
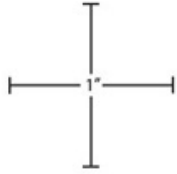

For all printable patterns or digital content: <http://tinyurl.com/11106-patterns-download>

### Spring Basket: block C

Note: Patterns are also printed in reverse for fusible appliqué.

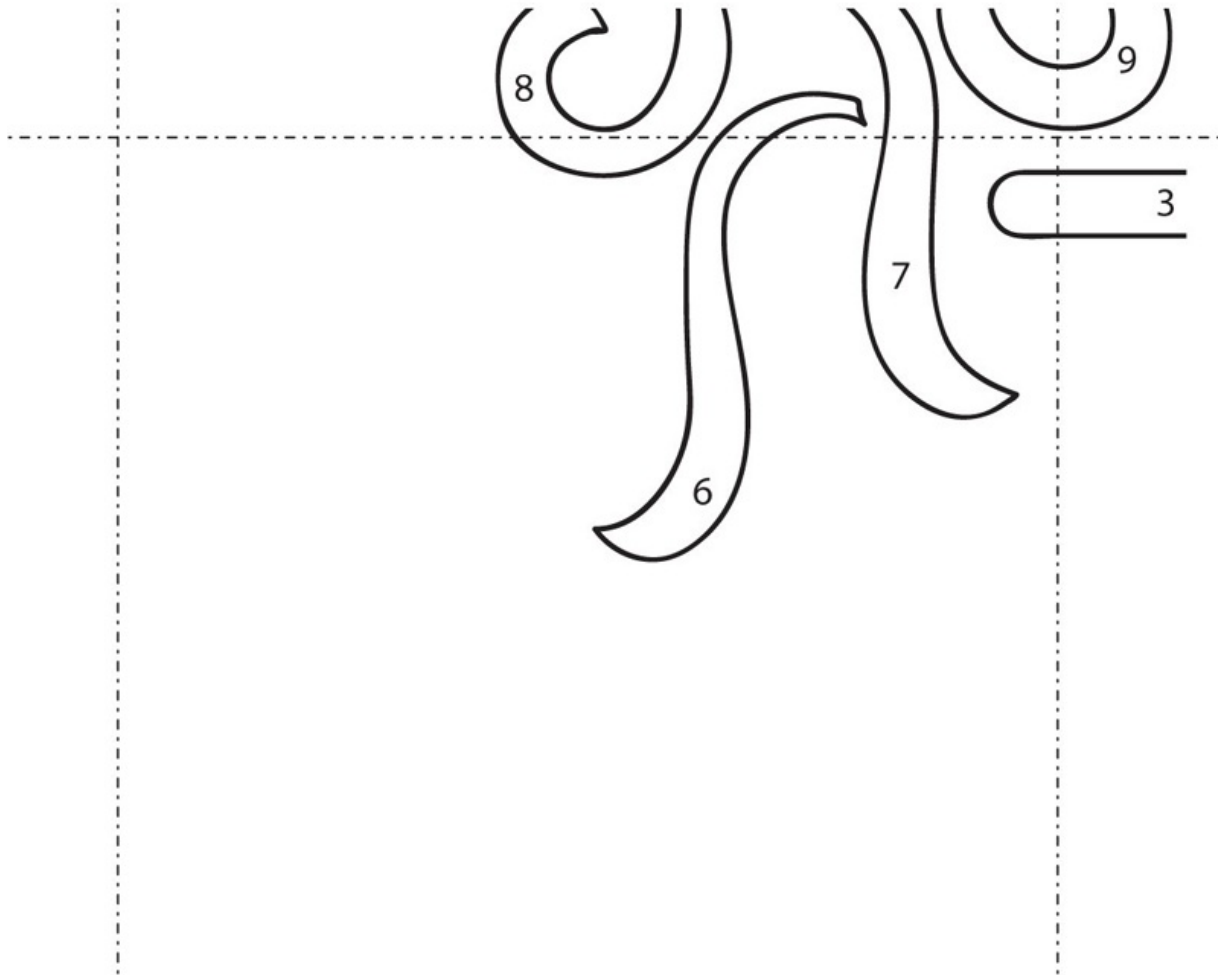
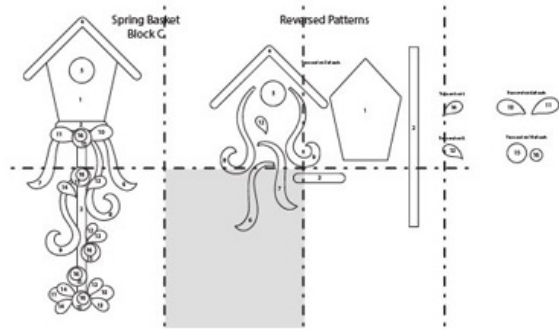
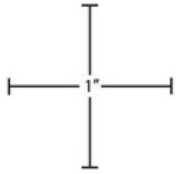

For all printable patterns or digital content: <http://tinyurl.com/11106-patterns-download>

# Spring Basket: block C

Note: Patterns are also printed in reverse for fusible appliqué.

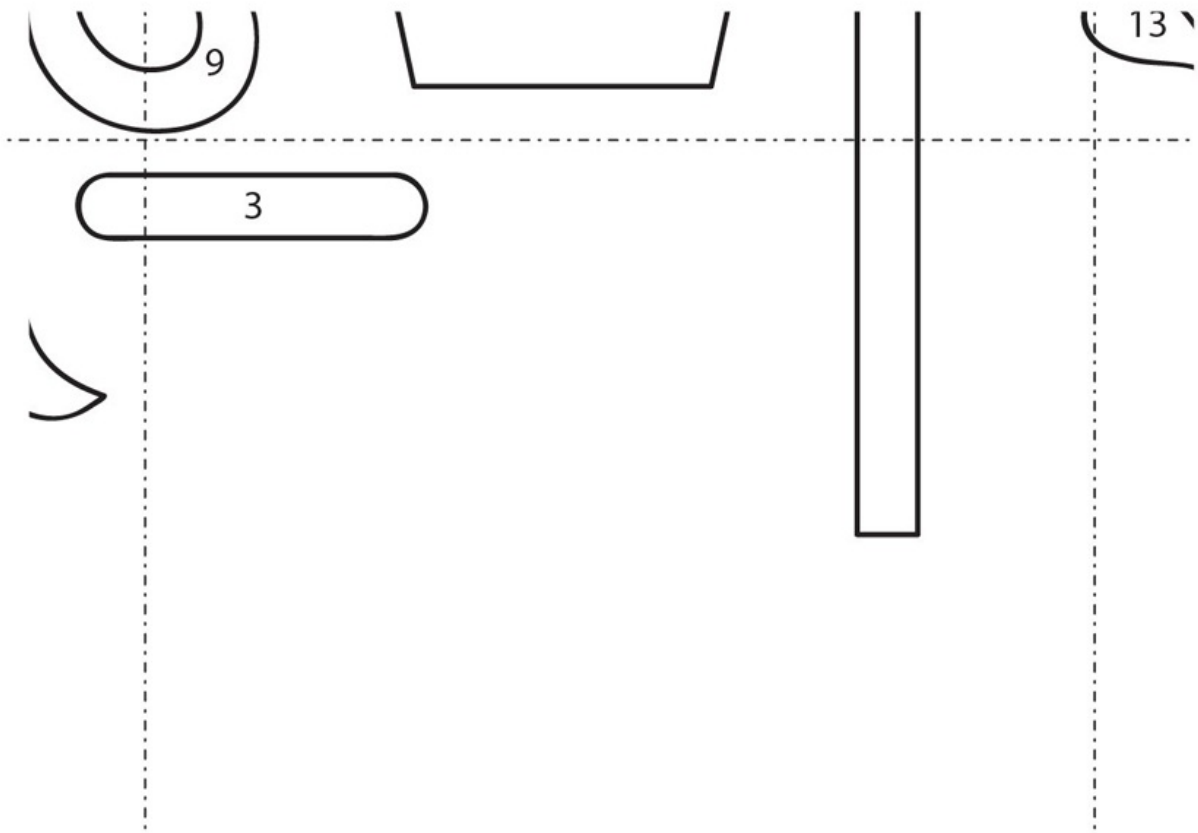
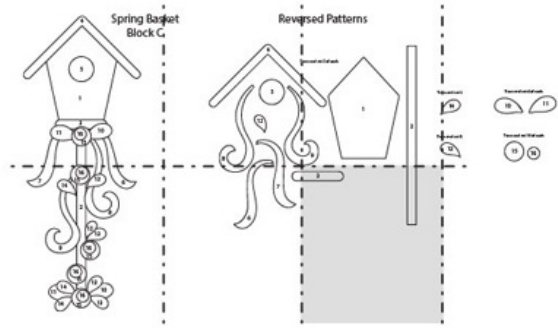
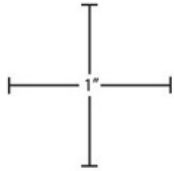

For all printable patterns or digital content: <http://tinyurl.com/11106-patterns-download>



## Spring Basket: block D

Note: Patterns are also printed in reverse for fusible appliqué.

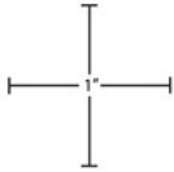

To make complete pattern, join the following pages, following the diagram for reference.

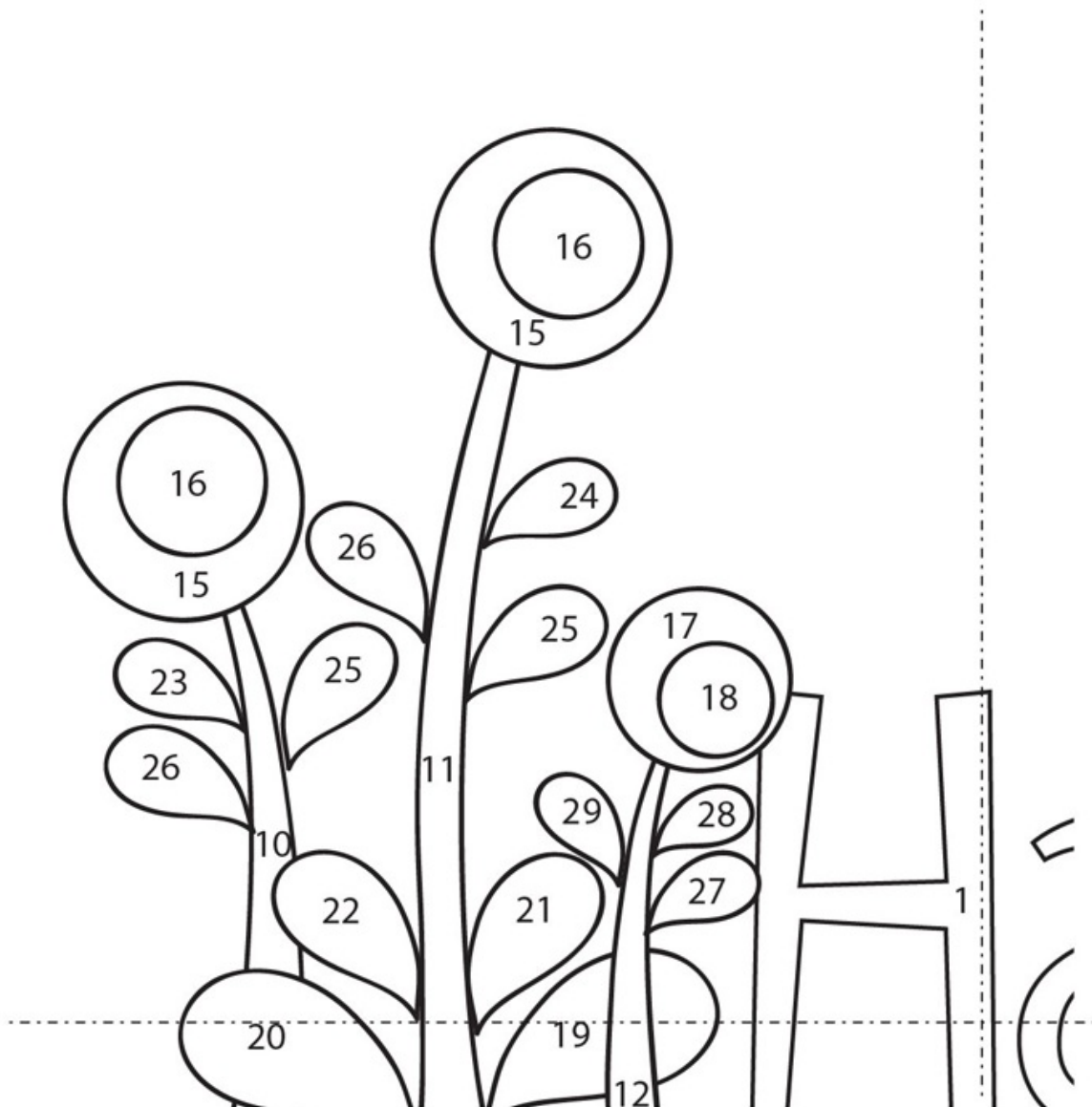
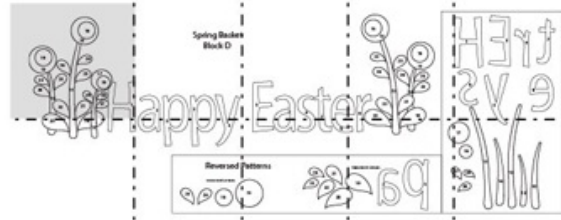

For all printable patterns or digital content: <http://tinyurl.com/11106->

[patterns-download](#)

### Spring Basket: block D

*Note: Patterns are also printed in reverse for fusible appliqué.*

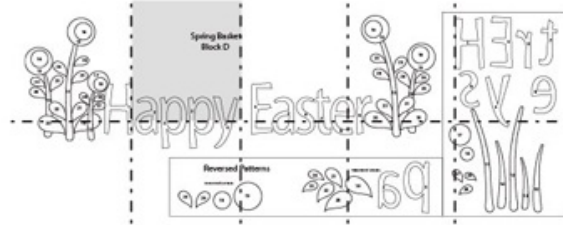
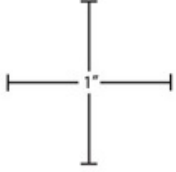

# Spring Basket Block D



For all printable patterns or digital content: <http://tinyurl.com/11106-patterns-download>

# Spring Basket: block D

Note: Patterns are also printed in reverse for fusible appliqué.

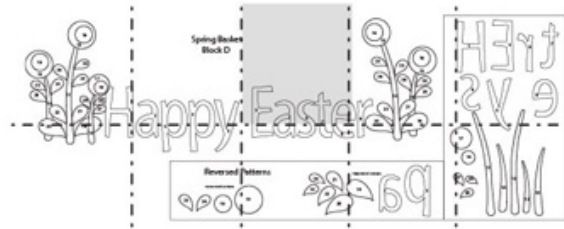
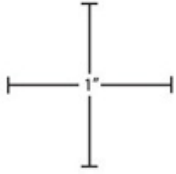

asket



For all printable patterns or digital content: <http://tinyurl.com/11106-patterns-download>

# Spring Basket: block D

Note: Patterns are also printed in reverse for fusible appliqué.

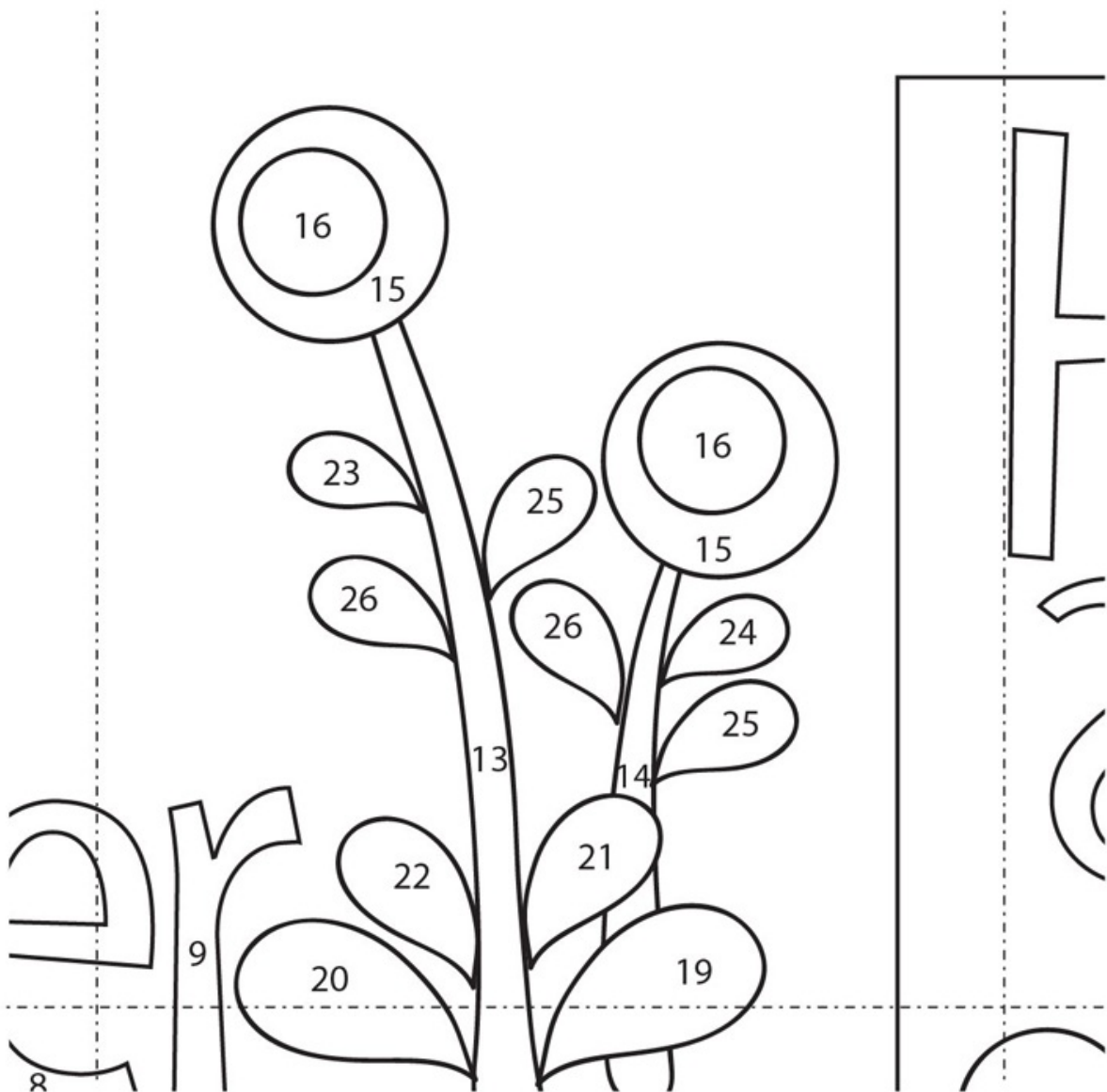
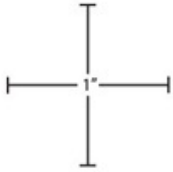

For all printable patterns or digital content: <http://tinyurl.com/11106->

patterns-download

# Spring Basket: block D

Note: Patterns are also printed in reverse for fusible appliqué.

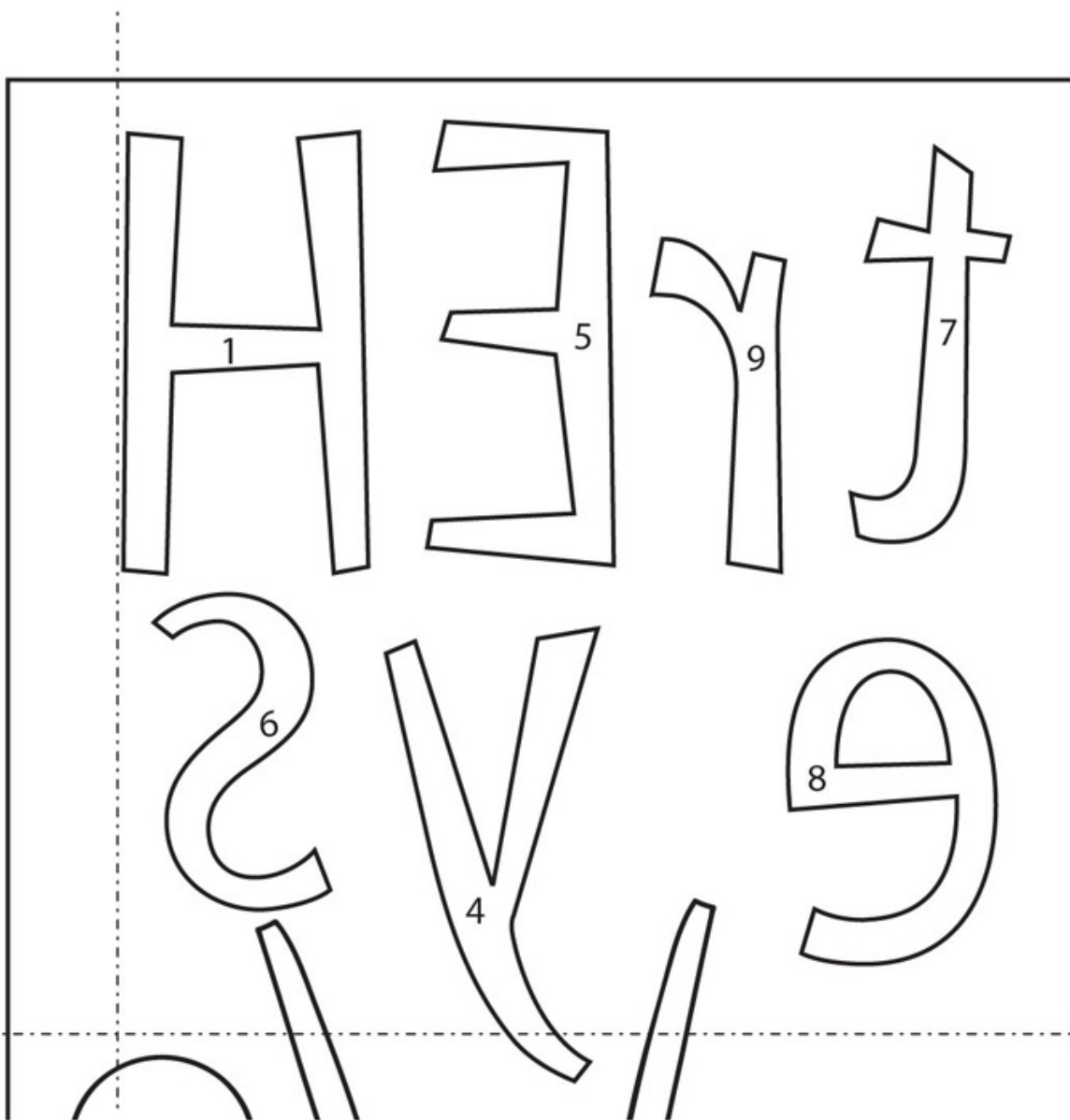
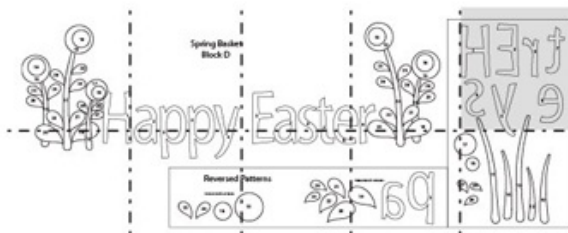
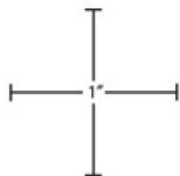



For all printable patterns or digital content: <http://tinyurl.com/11106-patterns-download>

### Spring Basket: block D

*Note: Patterns are also printed in reverse for fusible appliqué.*

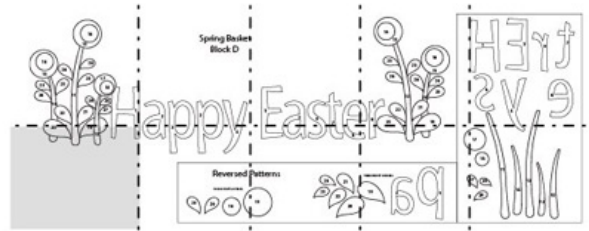
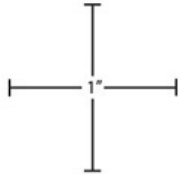

For all printable patterns or digital content: <http://tinyurl.com/11106-patterns-download>

# Spring Basket: block D

Note: Patterns are also printed in reverse for fusible appliqué.

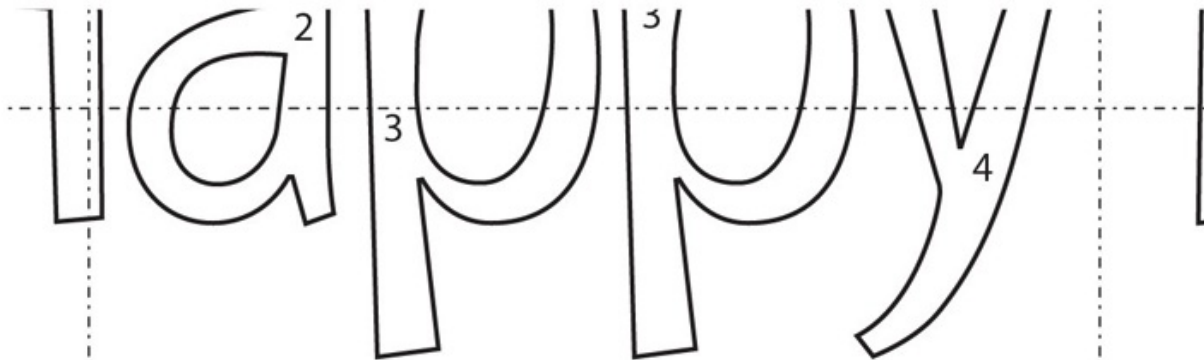
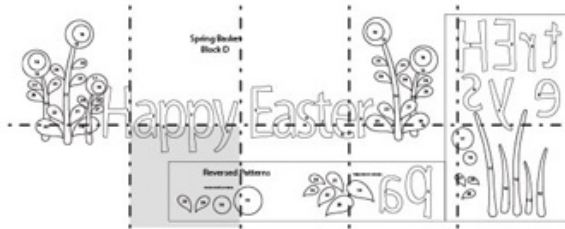
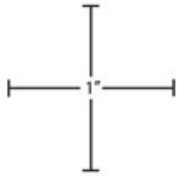

## Reversed Pattern

Trace and cut 4 of each.

25      26      16      15

For all printable patterns or digital content: <http://tinyurl.com/11106-patterns-download>

## Spring Basket: block D

Note: Patterns are also printed in reverse for fusible appliqué.

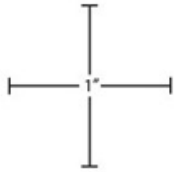

## ed Patterns

ch.

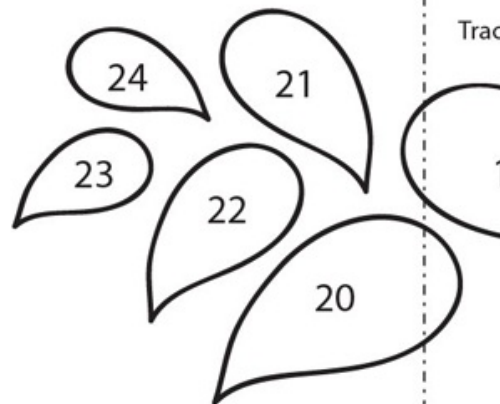
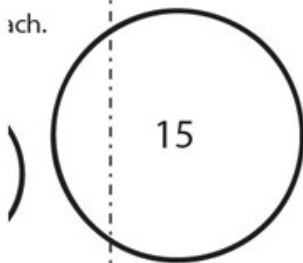

patterns-download

# Spring Basket: block D

Note: Patterns are also printed in reverse for fusible appliqué.

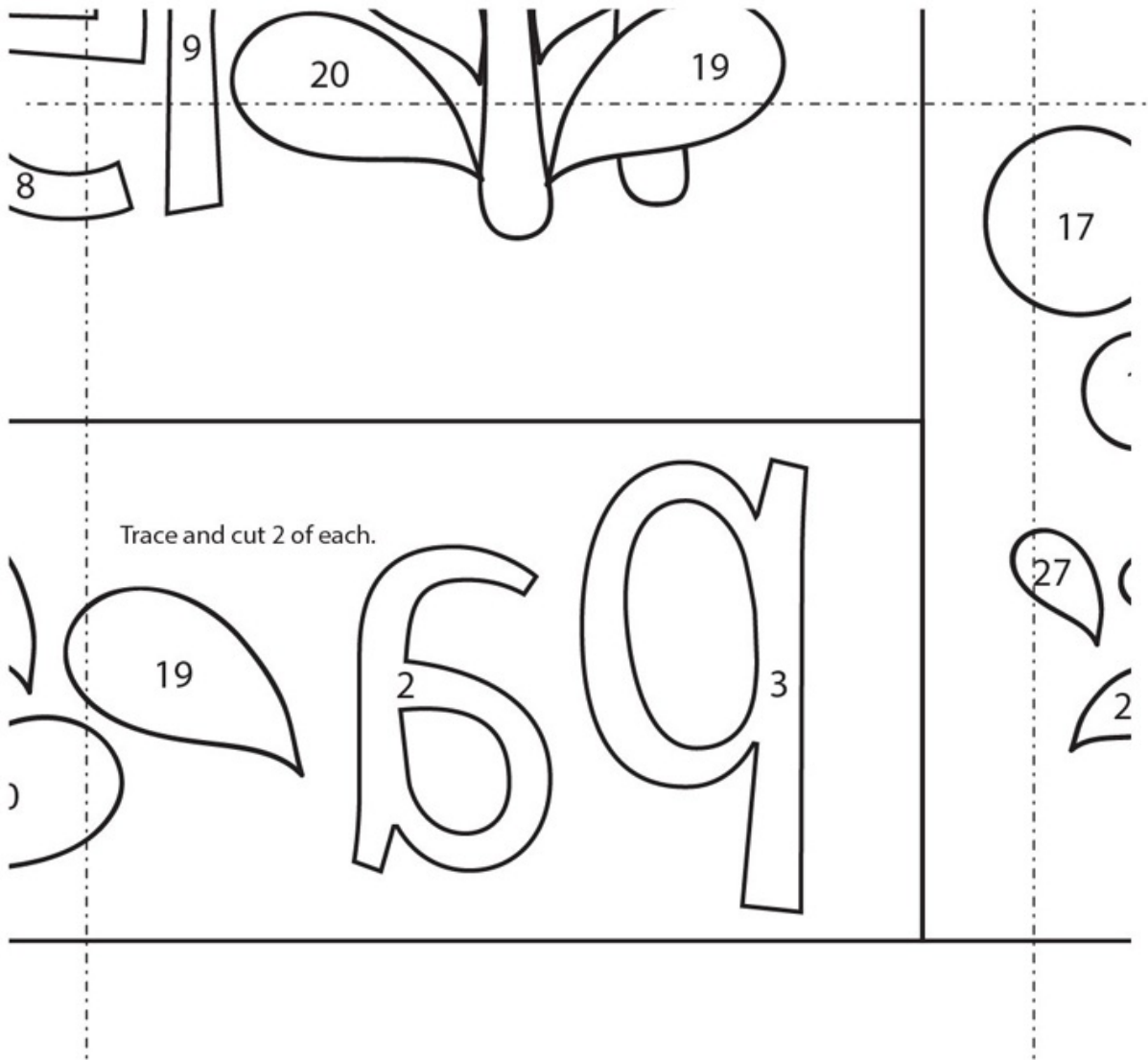
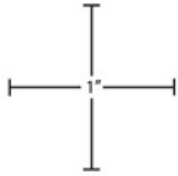

For all printable patterns or digital content: <http://tinyurl.com/11106-patterns-download>

# Spring Basket: block D

Note: Patterns are also printed in reverse for fusible appliqué.

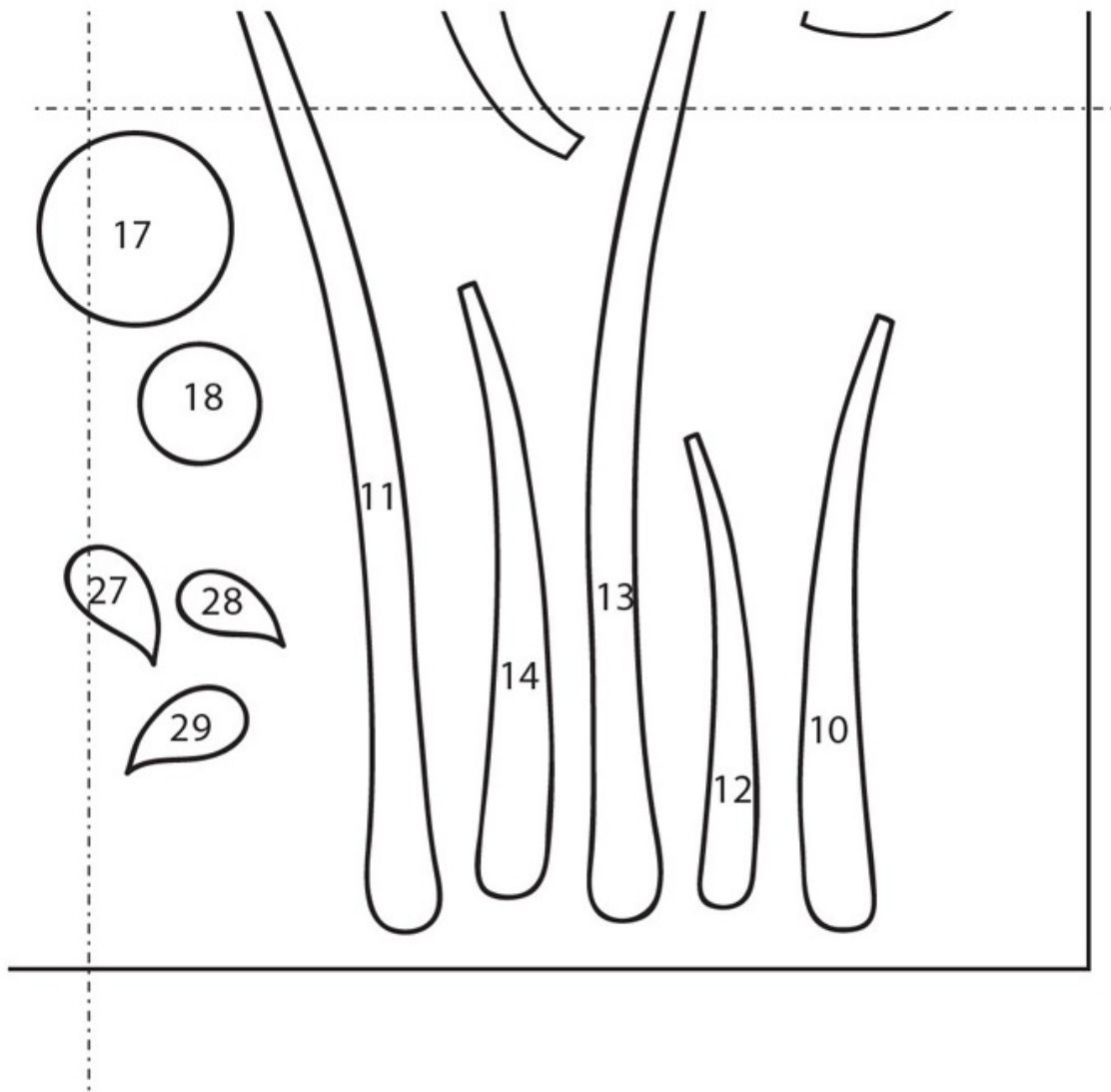
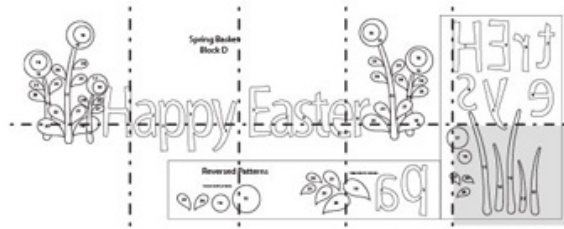
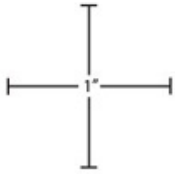

For all printable patterns or digital content: <http://tinyurl.com/11106->



patterns-download

## Liberty: block A

Note: Patterns are also printed in reverse for fusible appliqué.

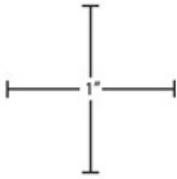

To make complete pattern, join the following pages, following the diagram for reference.

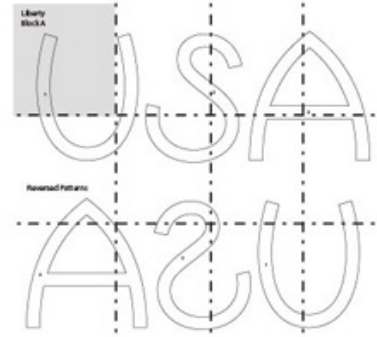

# Liberty Block A

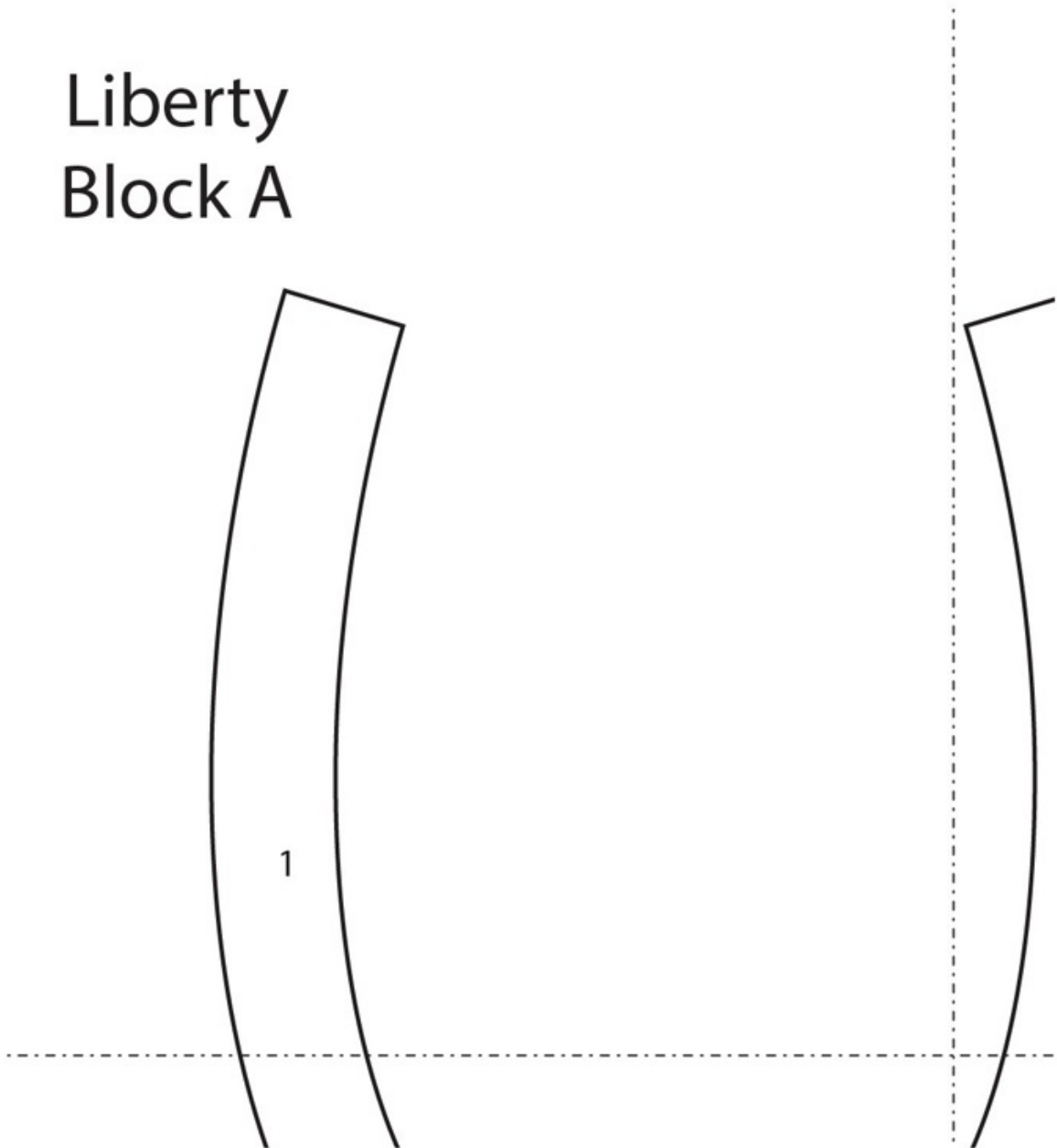

For all printable patterns or digital content: <http://tinyurl.com/11106-patterns-download>

**Liberty: block A**

*Note: Patterns are also printed in reverse for fusible appliqué.*

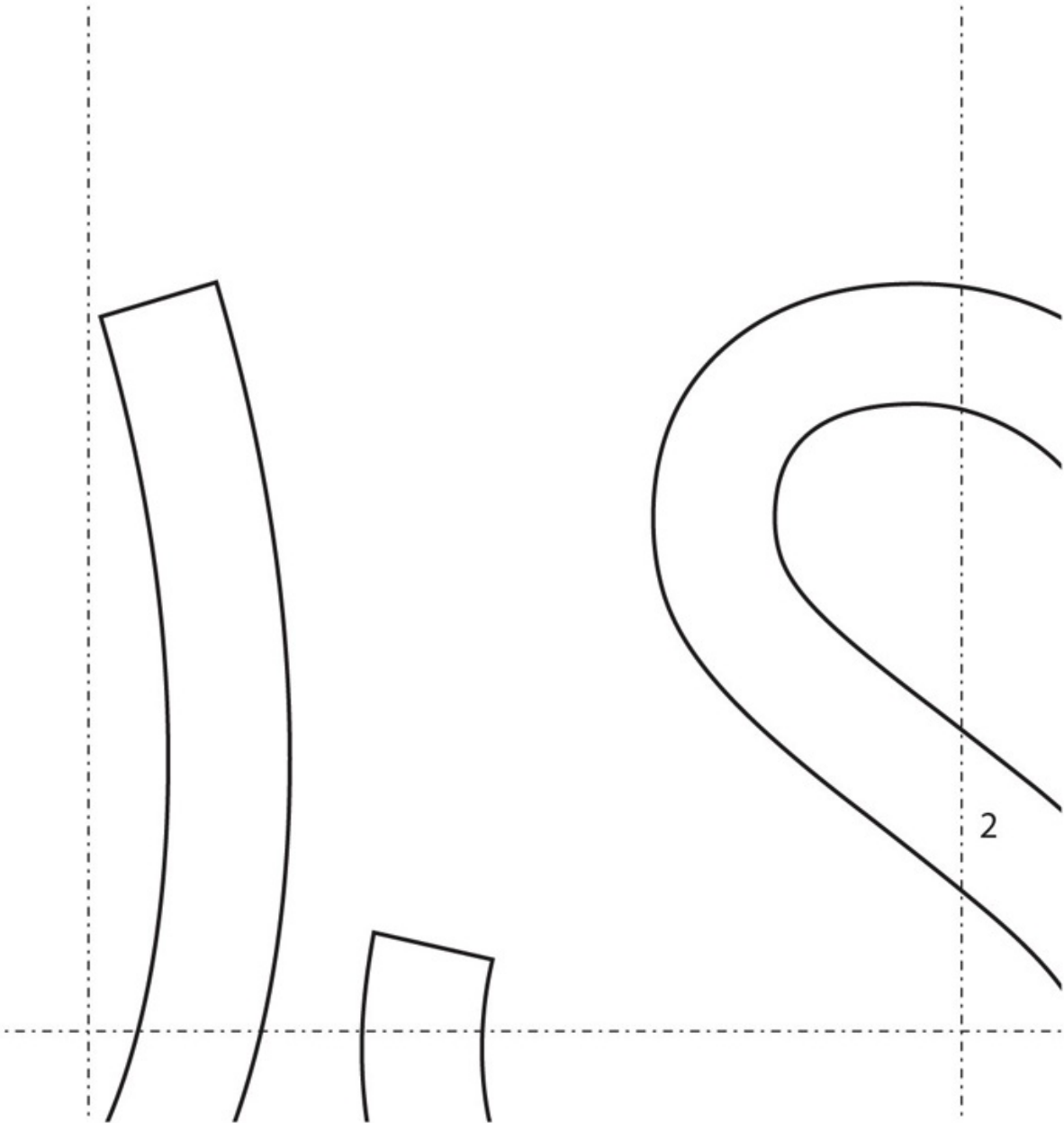
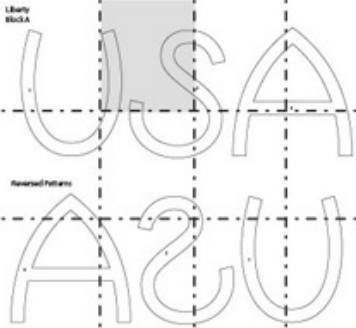
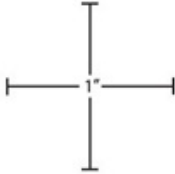

For all printable patterns or digital content: <http://tinyurl.com/11106-patterns-download>

# Liberty: block A

Note: Patterns are also printed in reverse for fusible appliqué.

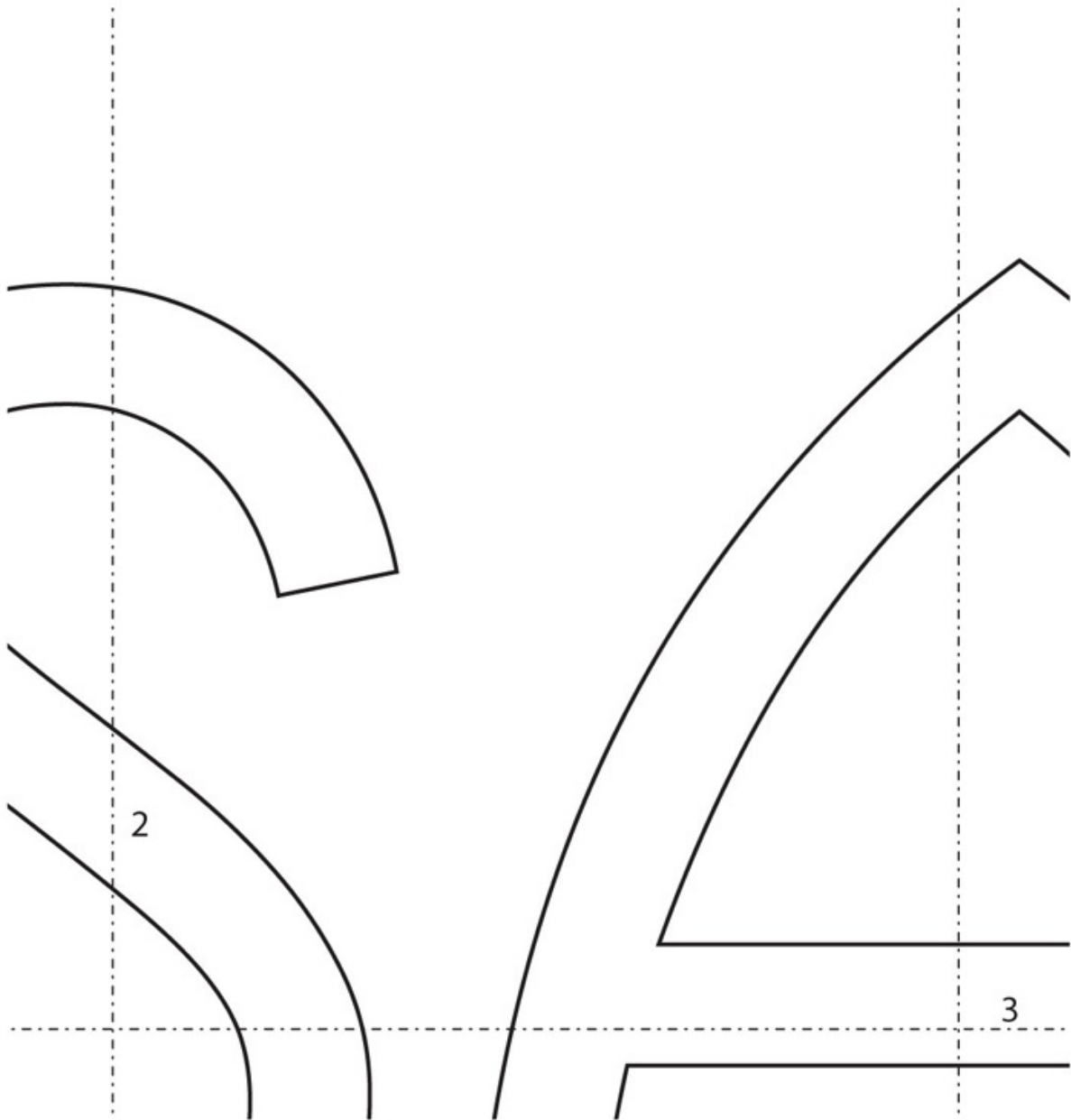
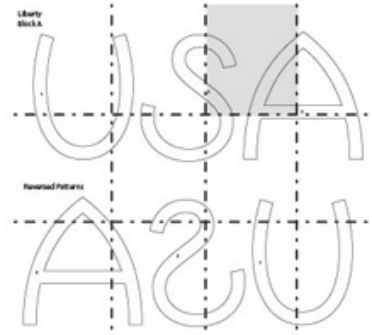
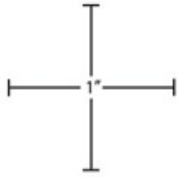

For all printable patterns or digital content: <http://tinyurl.com/11106-patterns-download>

# Liberty: block A

Note: Patterns are also printed in reverse for fusible appliqué.

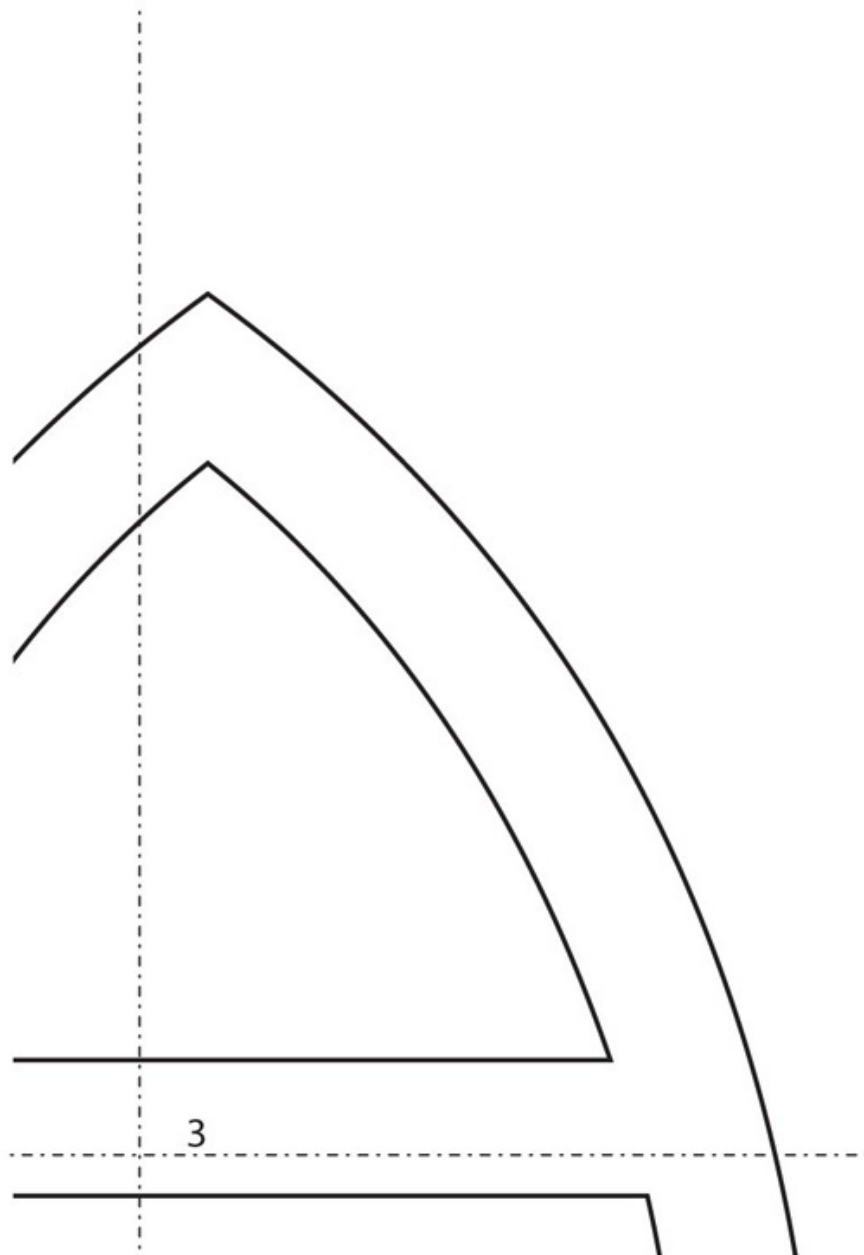
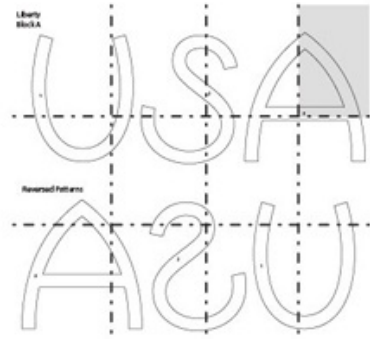
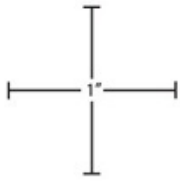



For all printable patterns or digital content: <http://tinyurl.com/11106-patterns-download>

## Liberty: block A

Note: Patterns are also printed in reverse for fusible appliqué.

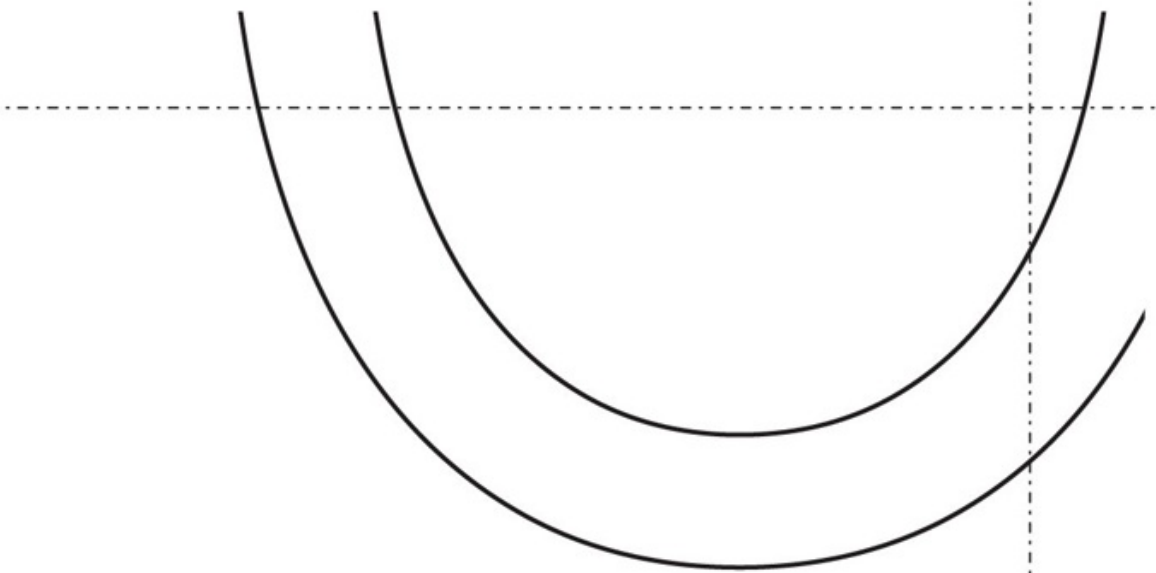
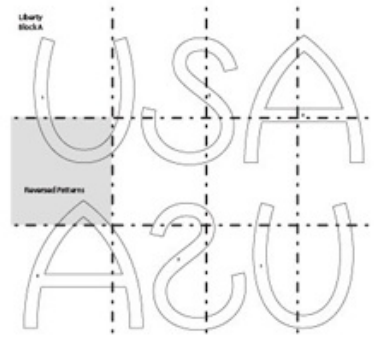
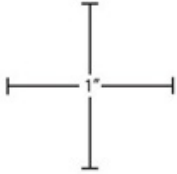

## Reversed Patterns

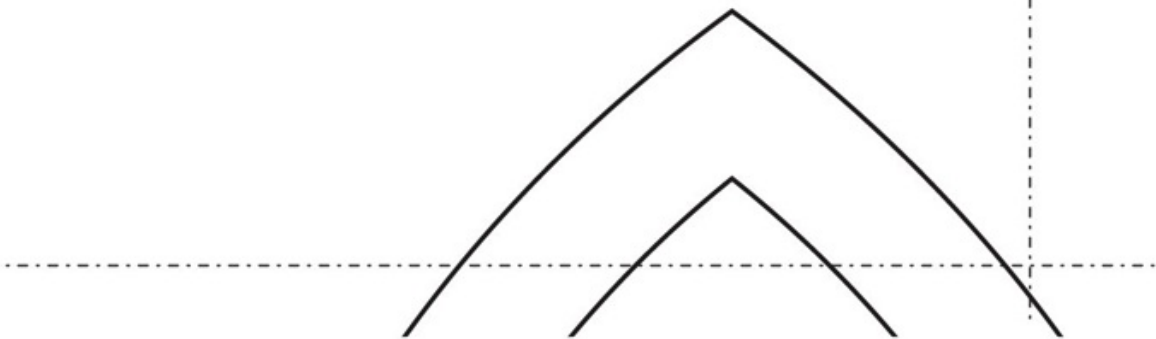

For all printable patterns or digital content: <http://tinyurl.com/11106-patterns-download>

# Liberty: block A

Note: Patterns are also printed in reverse for fusible appliqué.

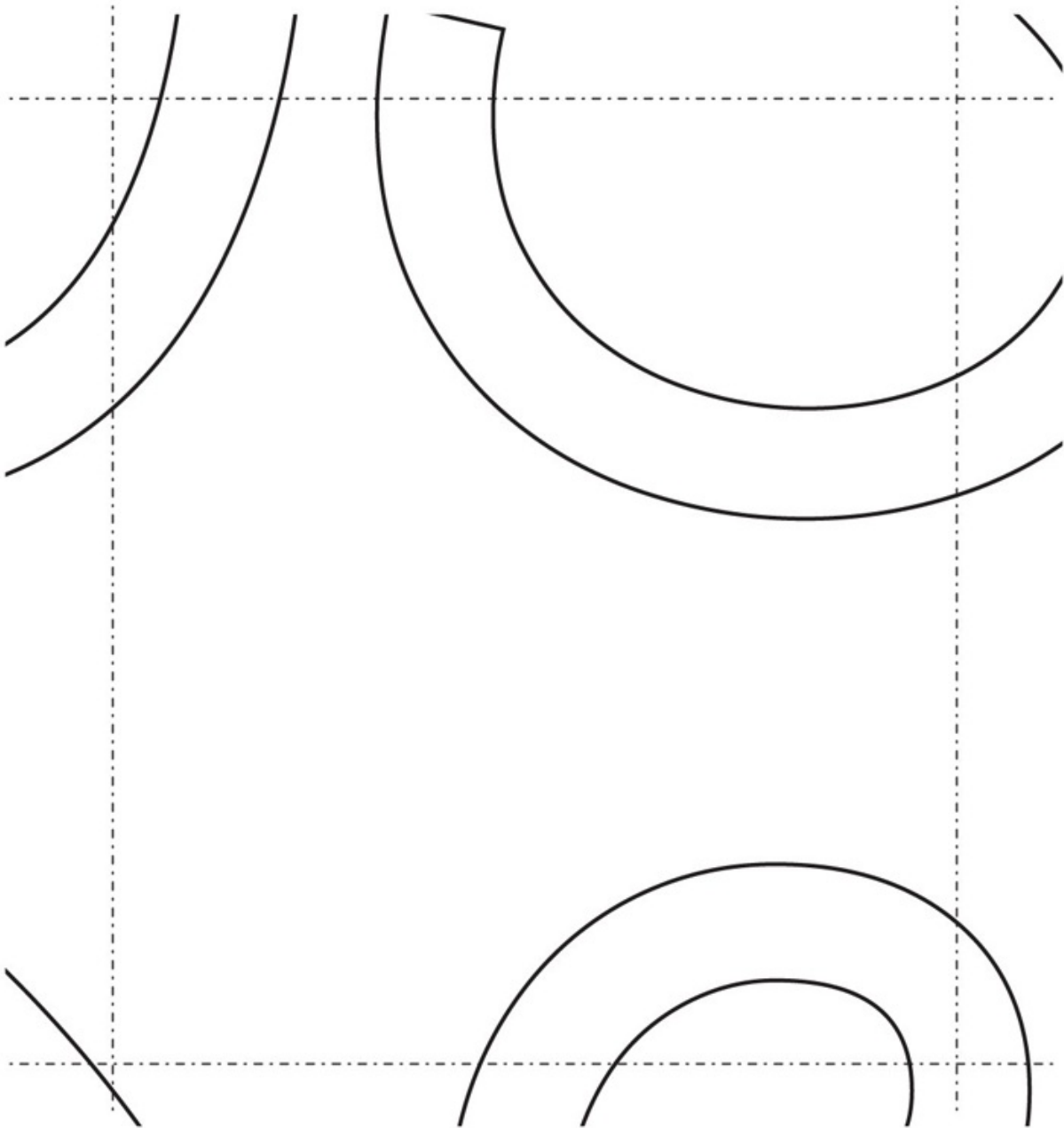
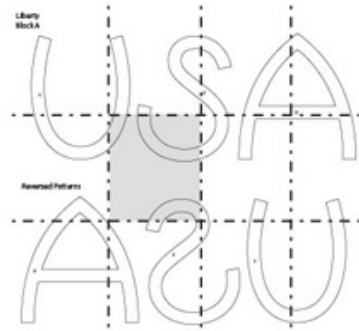
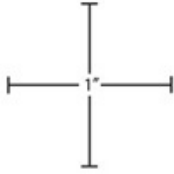

For all printable patterns or digital content: <http://tinyurl.com/11106-patterns-download>

# Liberty: block A

Note: Patterns are also printed in reverse for fusible appliqué.

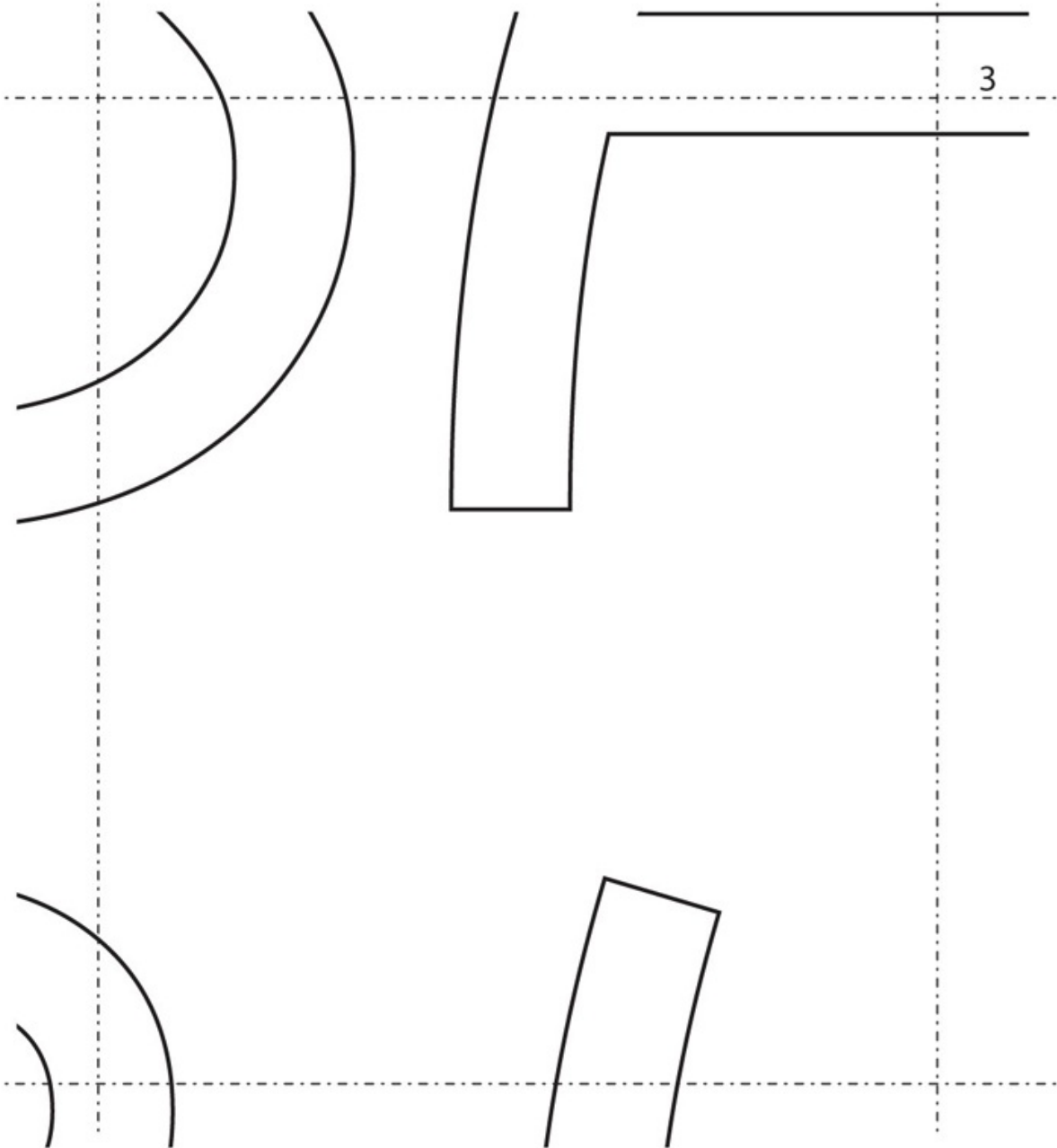
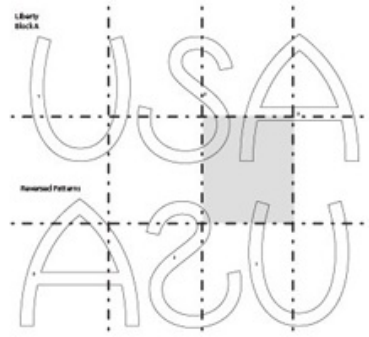
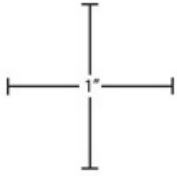

For all printable patterns or digital content: <http://tinyurl.com/11106-patterns-download>

# Liberty: block A

Note: Patterns are also printed in reverse for fusible appliqué.

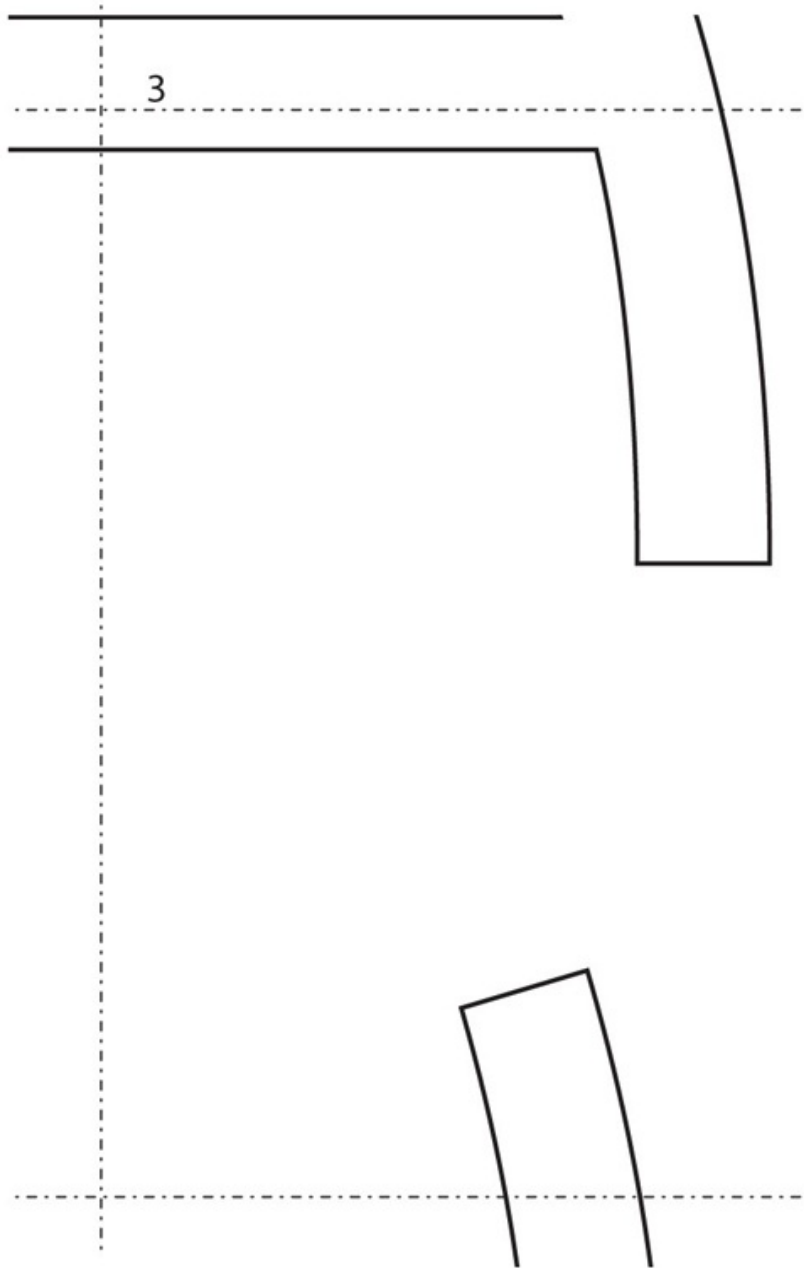
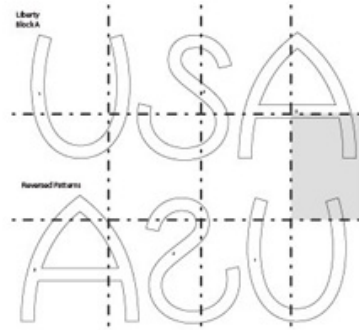
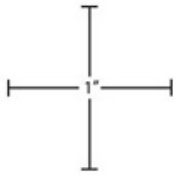



For all printable patterns or digital content: <http://tinyurl.com/11106-patterns-download>

# Liberty: block A

Note: Patterns are also printed in reverse for fusible appliqué.

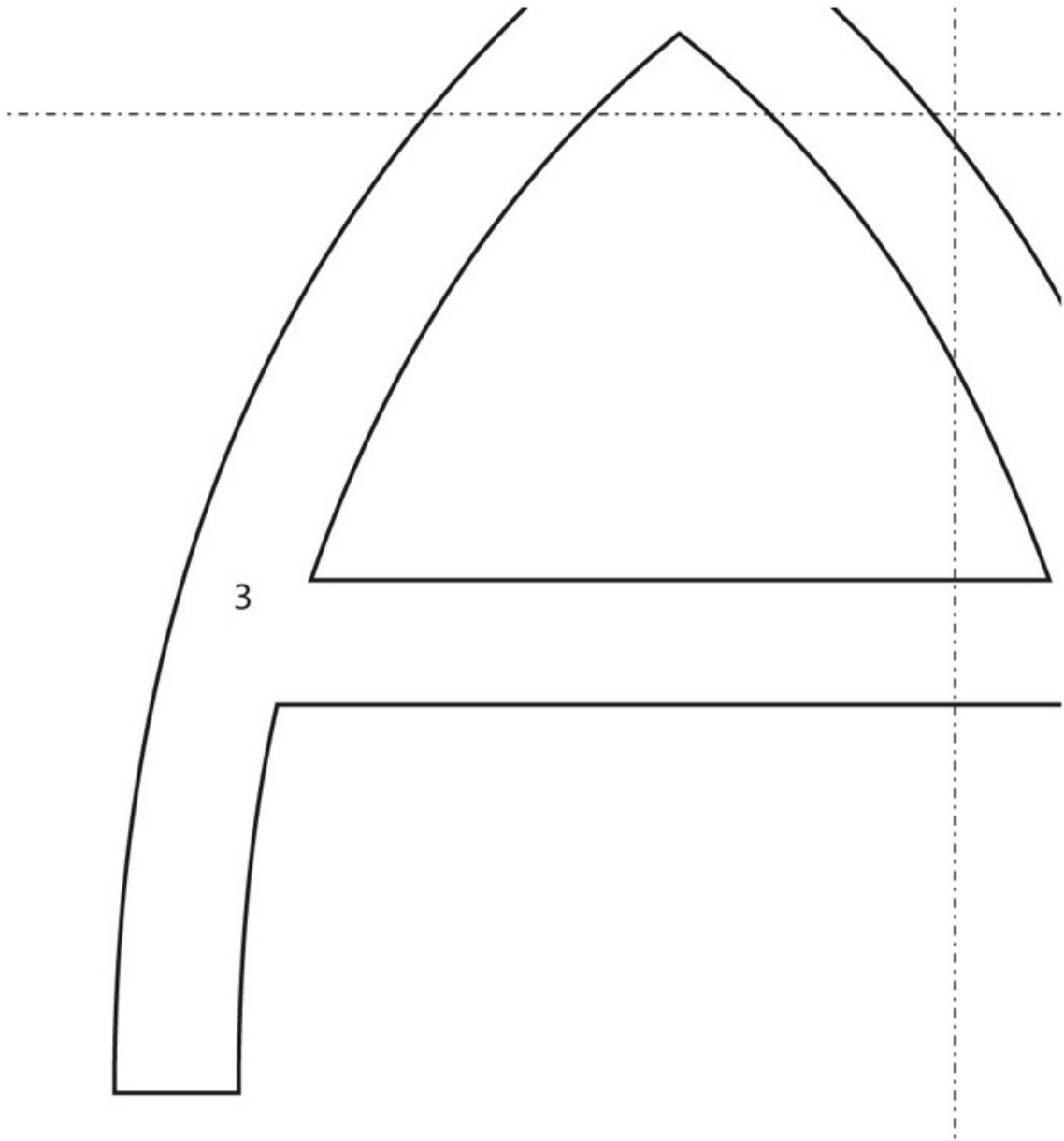
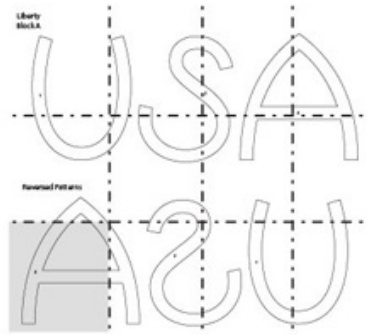
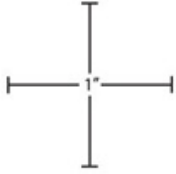

For all printable patterns or digital content: <http://tinyurl.com/11106-patterns-download>

# Liberty: block A

Note: Patterns are also printed in reverse for fusible appliqué.

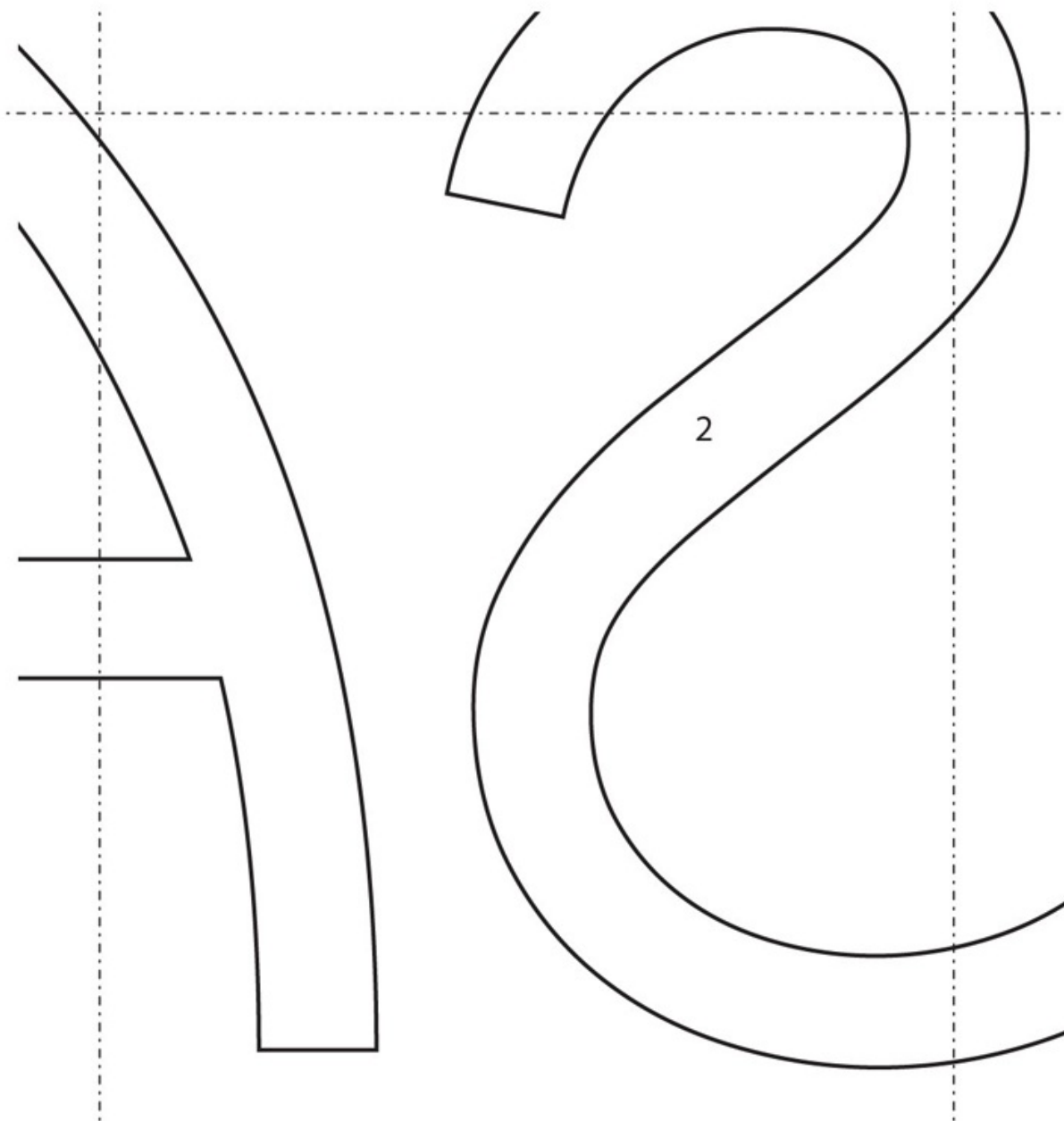
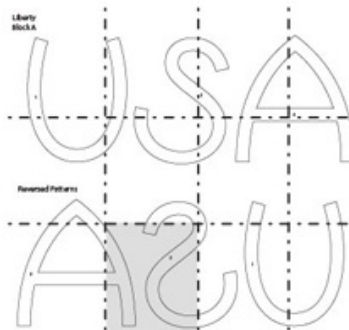
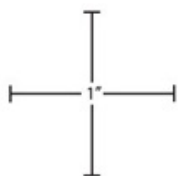

For all printable patterns or digital content: <http://tinyurl.com/11106-patterns-download>

# Liberty: block A

Note: Patterns are also printed in reverse for fusible appliqué.

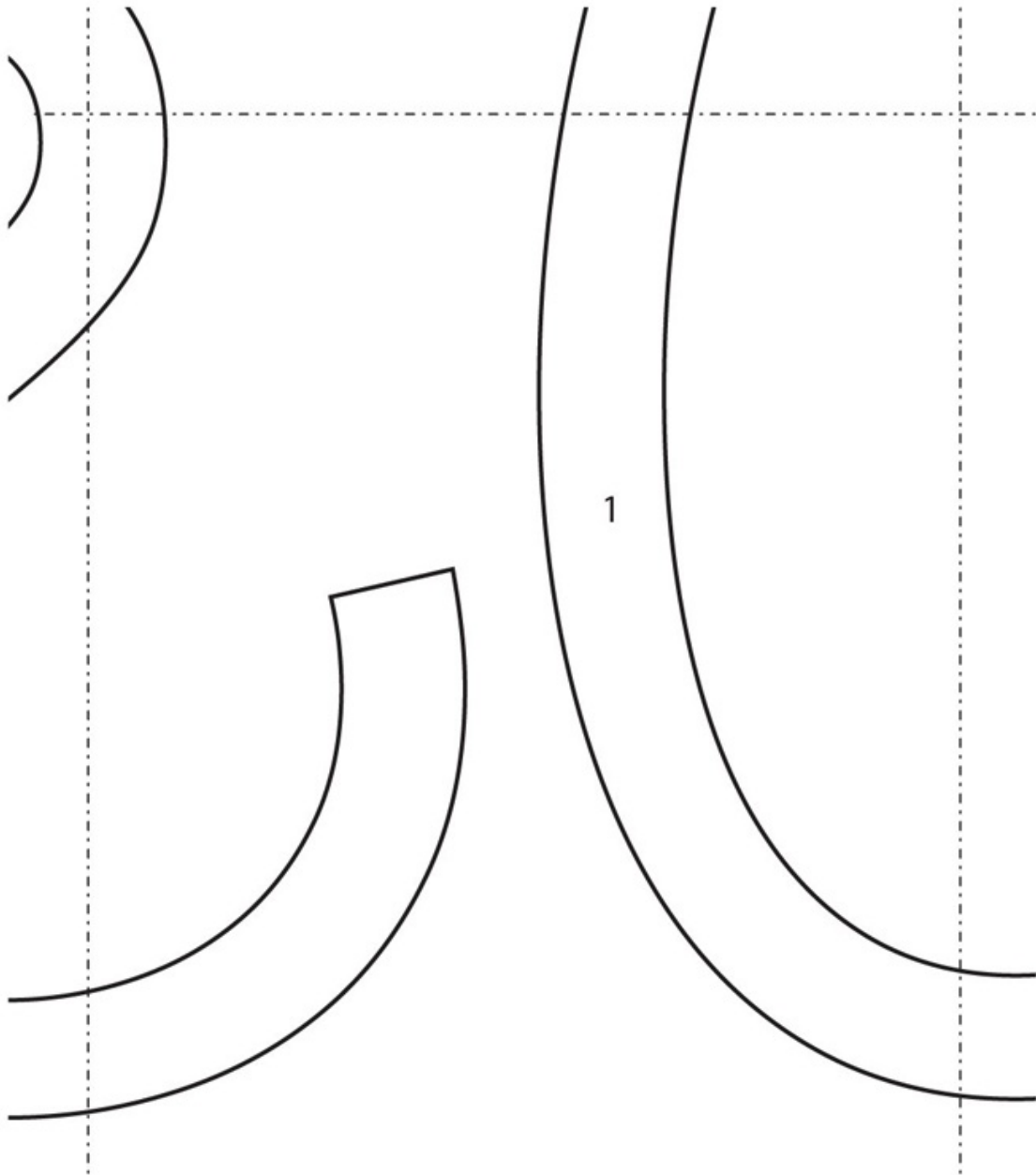
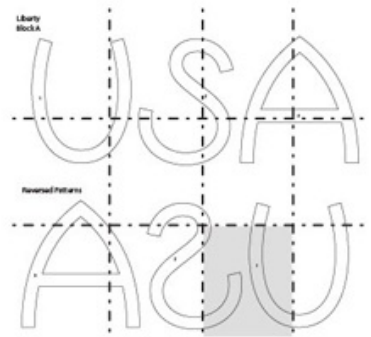
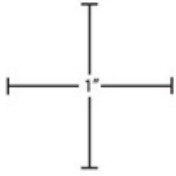

For all printable patterns or digital content: <http://tinyurl.com/11106-patterns-download>

# Liberty: block A

Note: Patterns are also printed in reverse for fusible appliqué.

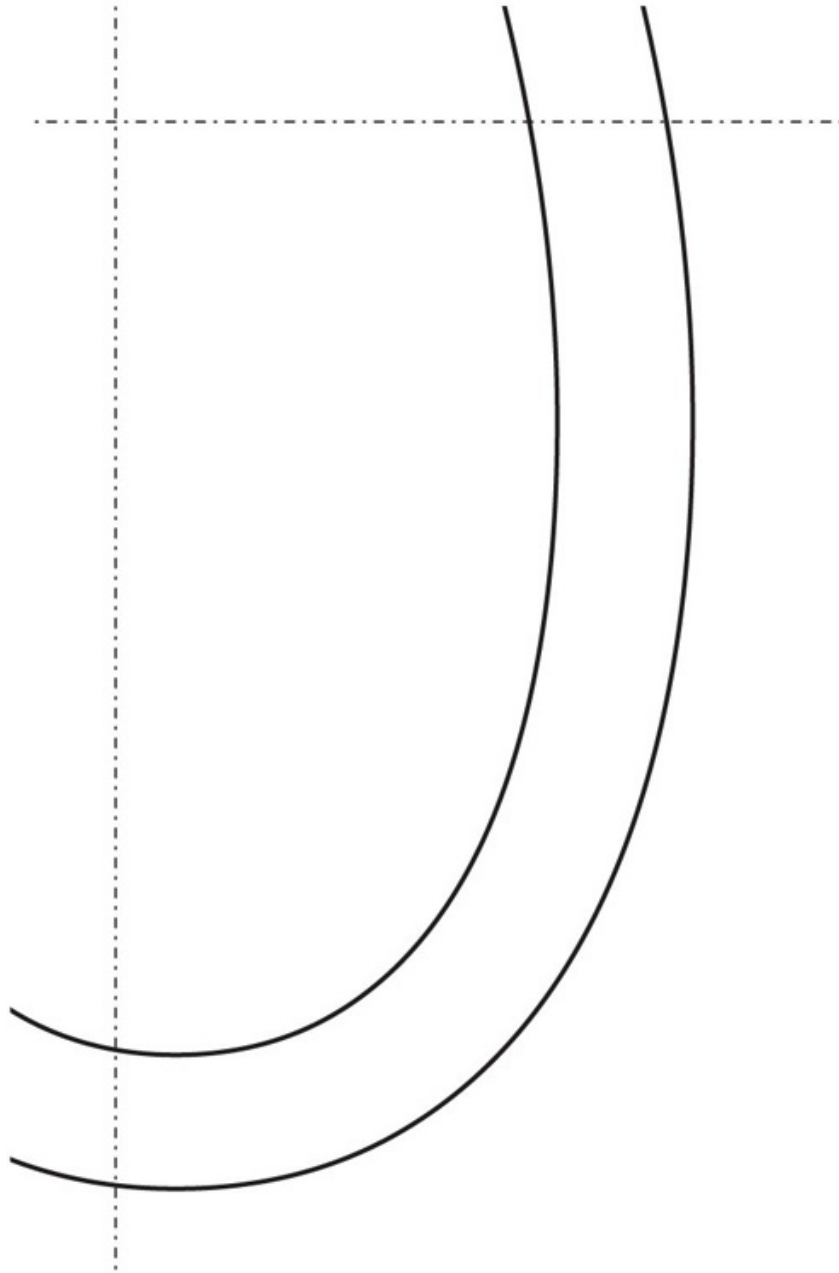
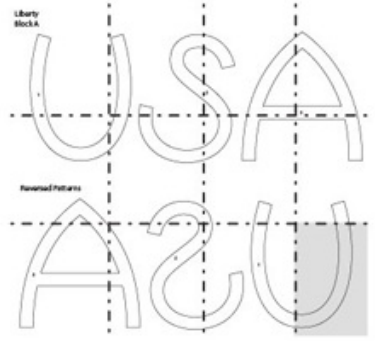
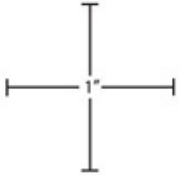



For all printable patterns or digital content: <http://tinyurl.com/11106-patterns-download>

## Liberty: block B

Note: Patterns are also printed in reverse for fusible appliqué.

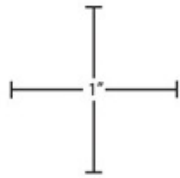

To make complete pattern, join the following pages, following the diagram for reference.

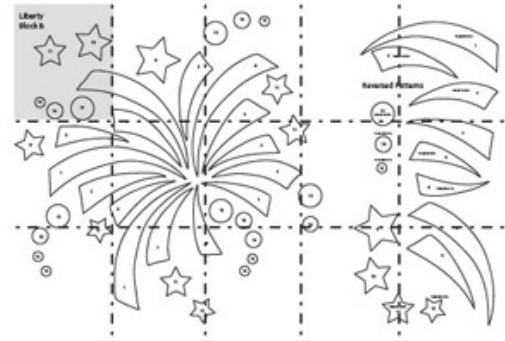

## Liberty Block B

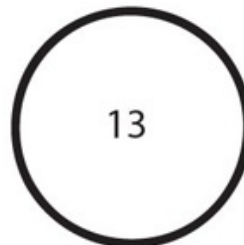

For all printable patterns or digital content: <http://tinyurl.com/11106-patterns-download>

# Liberty: block B

Note: Patterns are also printed in reverse for fusible appliqué.

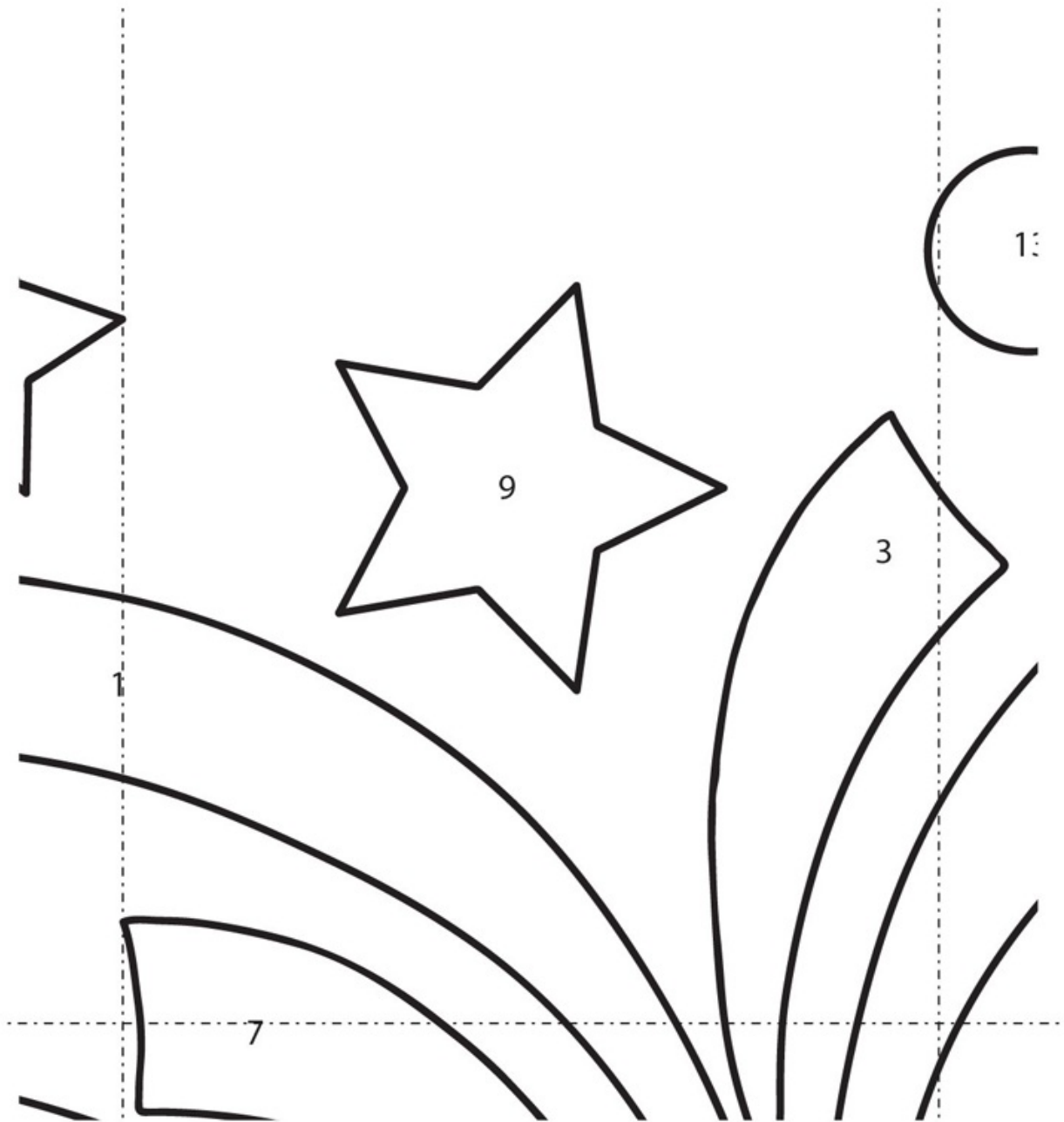
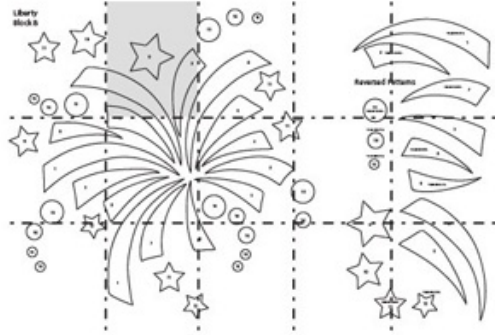
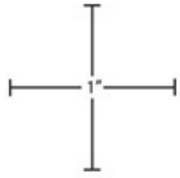

For all printable patterns or digital content: <http://tinyurl.com/11106-patterns-download>

# Liberty: block B

Note: Patterns are also printed in reverse for fusible appliqué.

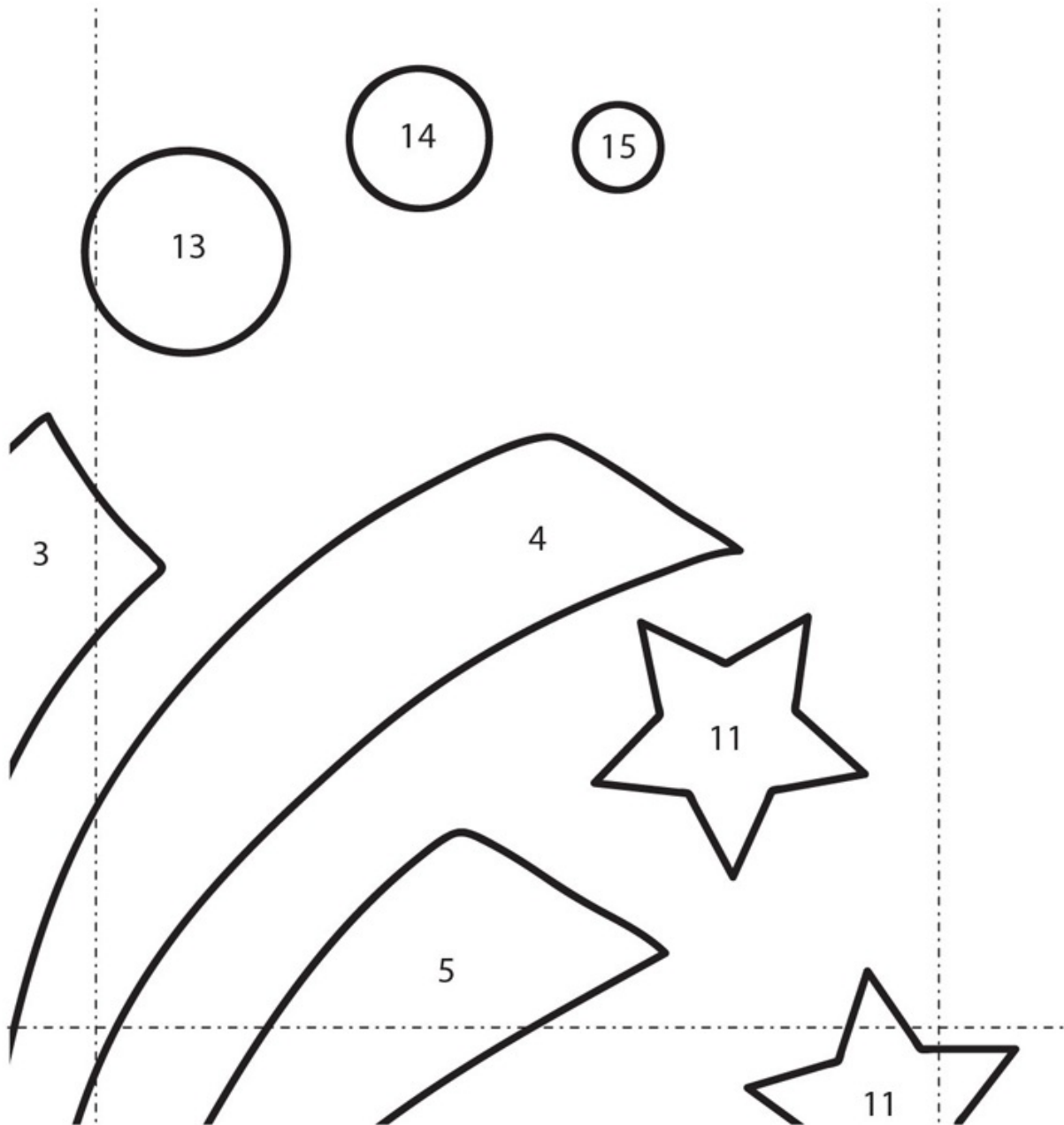
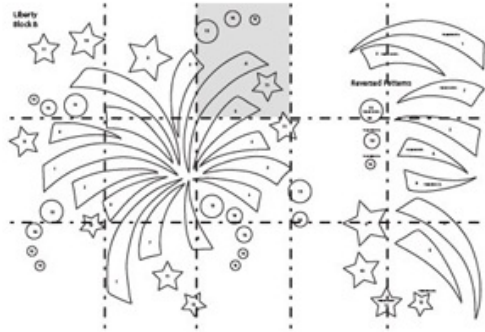
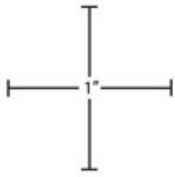

For all printable patterns or digital content: <http://tinyurl.com/11106-patterns-download>

# Liberty: block B

Note: Patterns are also printed in reverse for fusible appliqué.

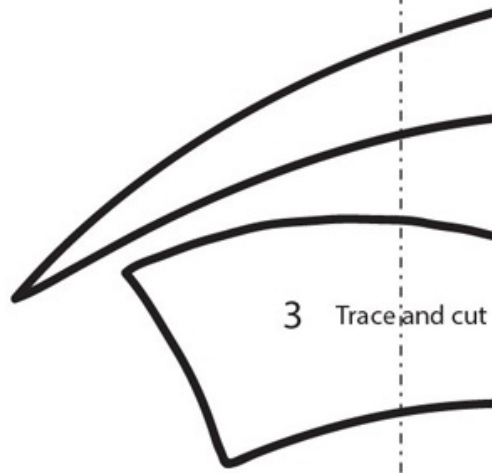
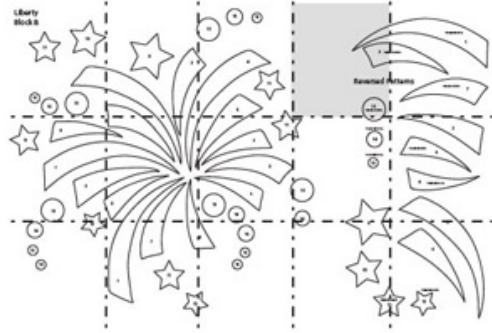
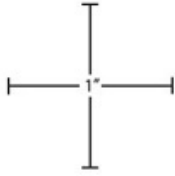

## Reversed Patt

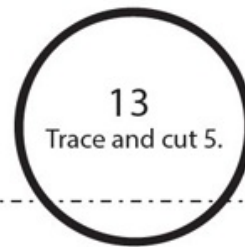
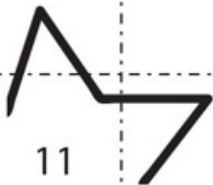



patterns-download

**Liberty: block B**

Note: Patterns are also printed in reverse for fusible appliqué.

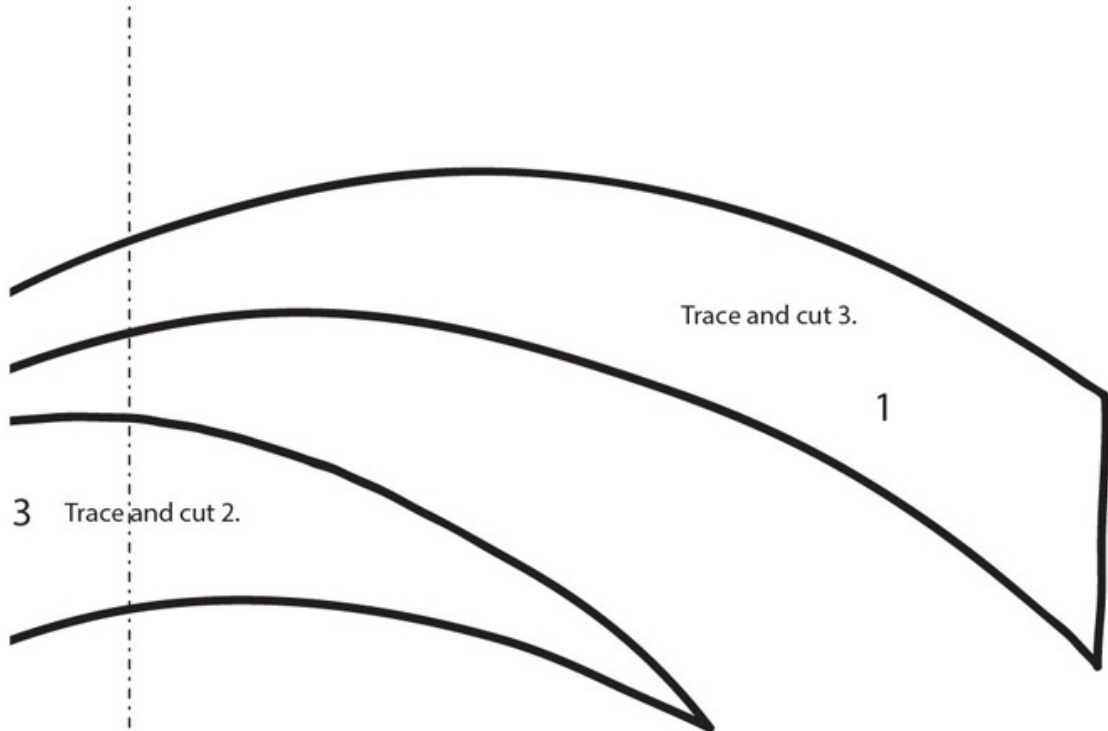
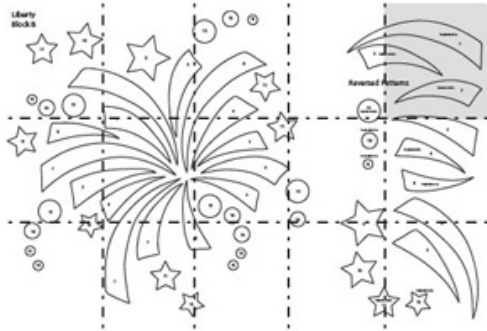
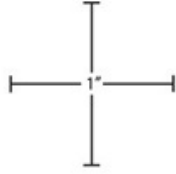

**ed Patterns**

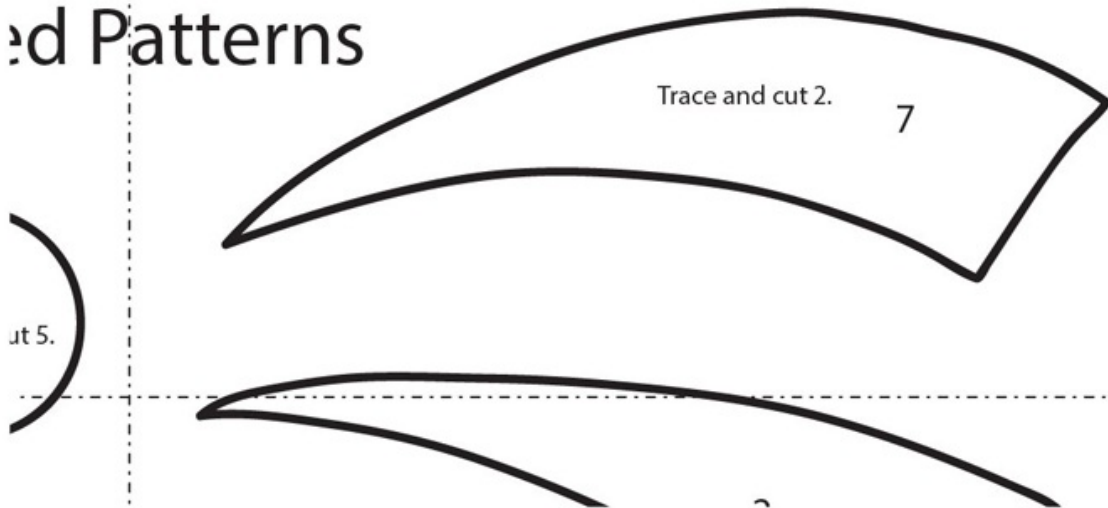

For all printable patterns or digital content: <http://tinyurl.com/11106-patterns-download>

# Liberty: block B

Note: Patterns are also printed in reverse for fusible appliqué.

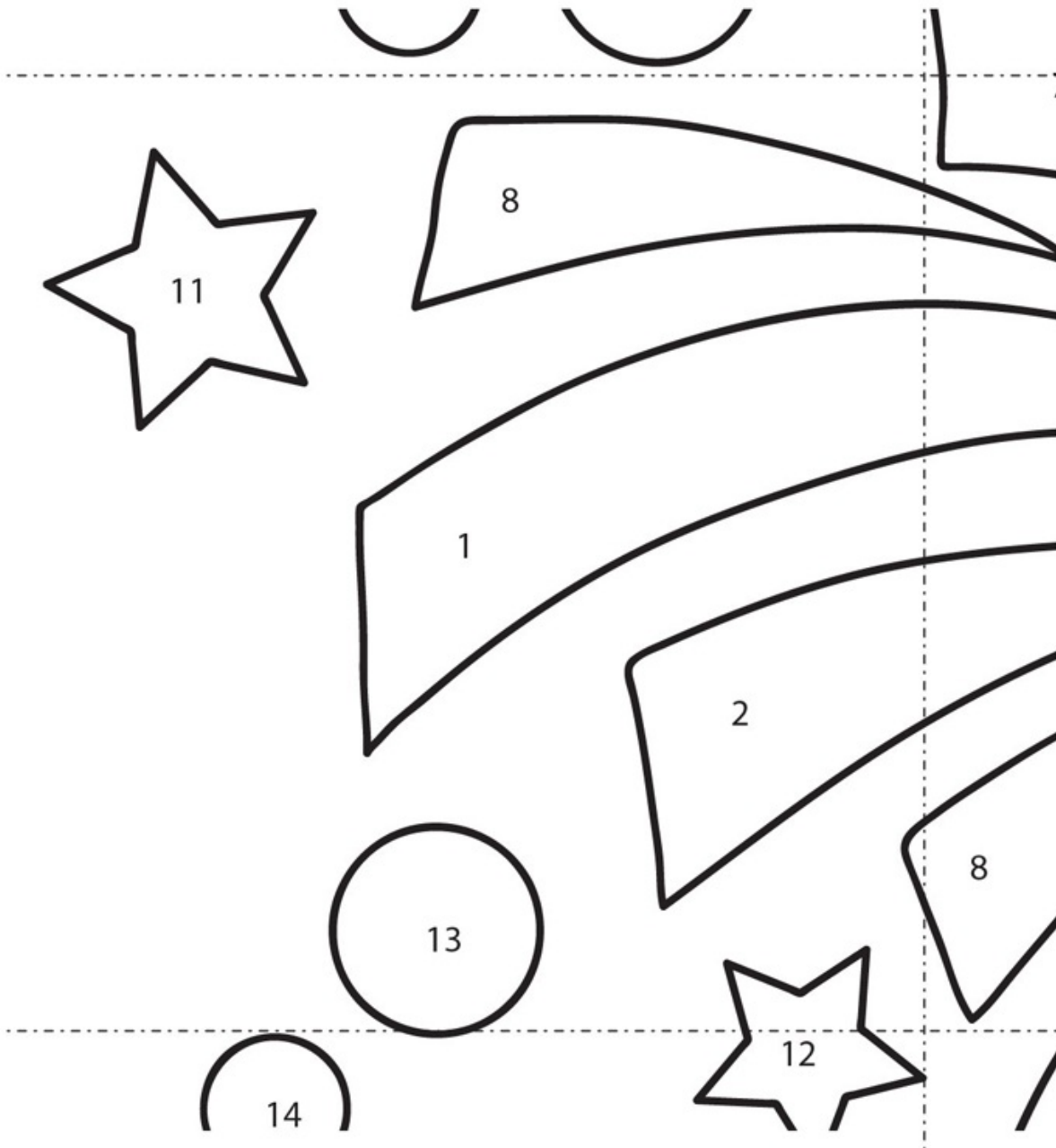
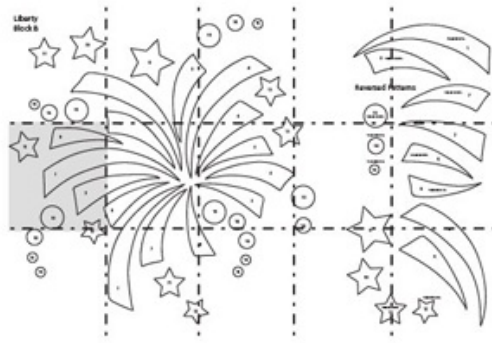
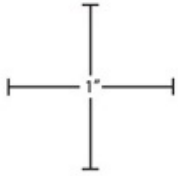

For all printable patterns or digital content: <http://tinyurl.com/11106-patterns-download>

# Liberty: block B

Note: Patterns are also printed in reverse for fusible appliqué.

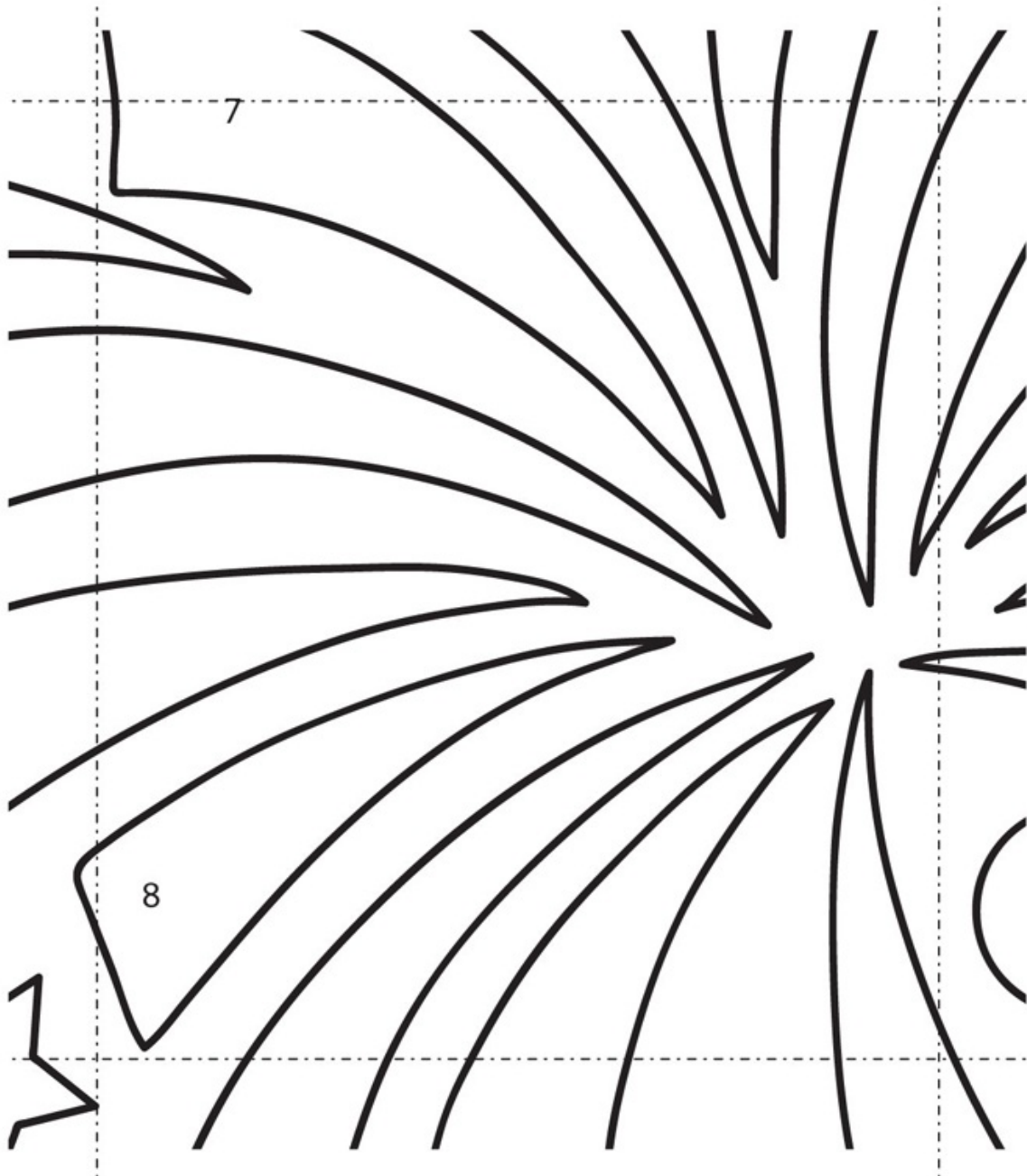
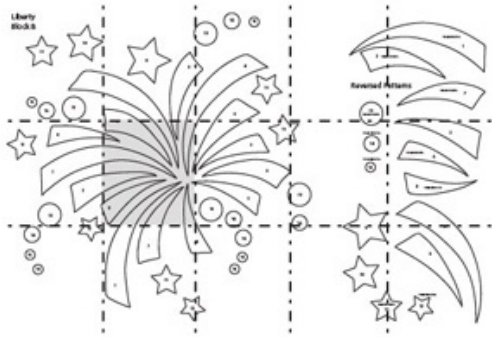
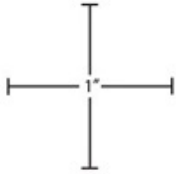

For all printable patterns or digital content: <http://tinyurl.com/11106-patterns-download>

# Liberty: block B

Note: Patterns are also printed in reverse for fusible appliqué.

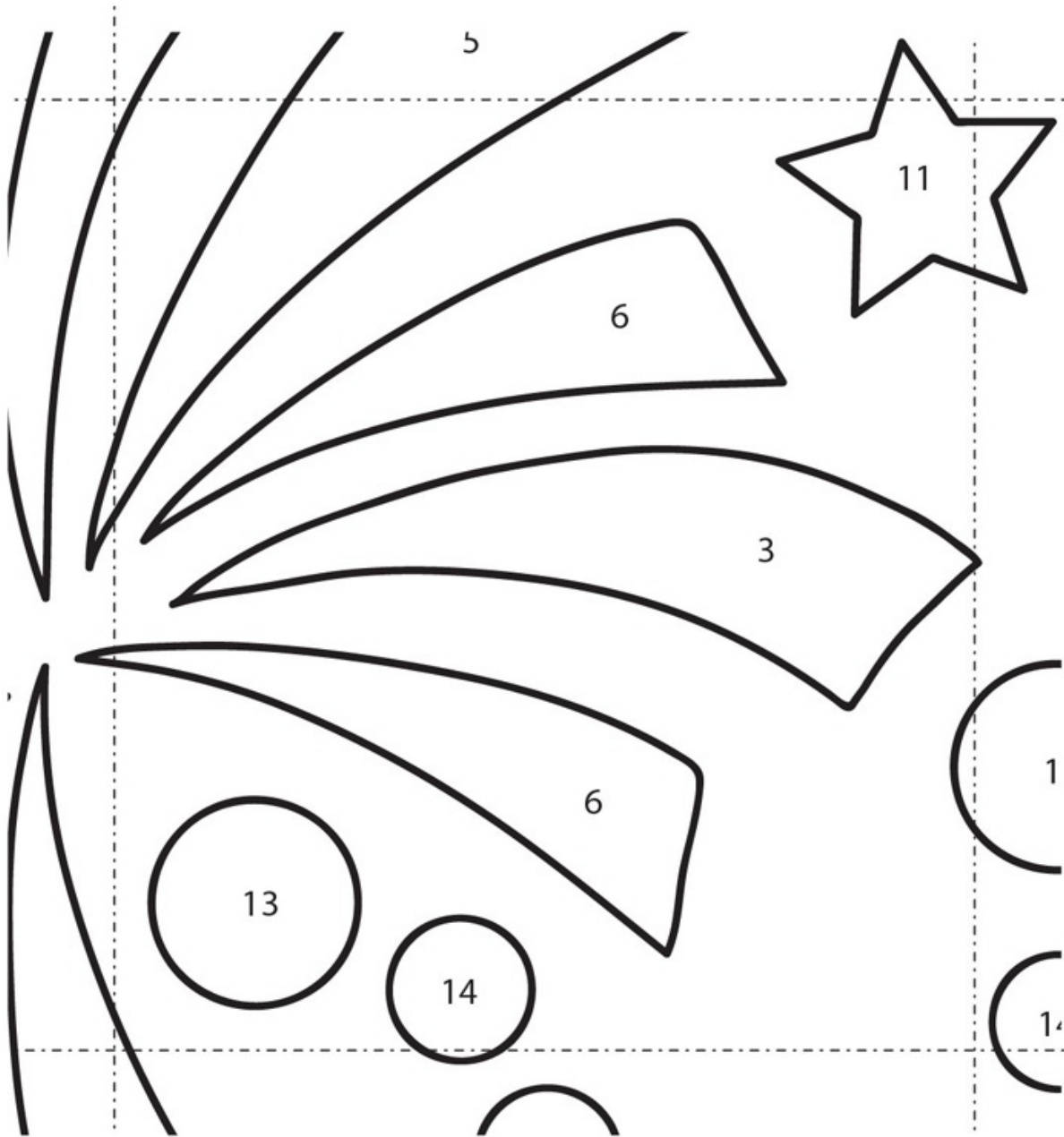
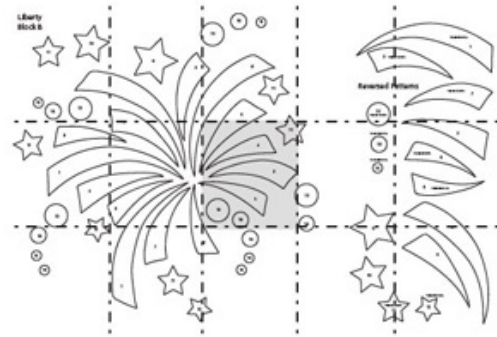
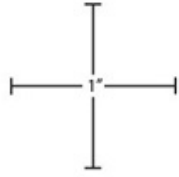

For all printable patterns or digital content: <http://tinyurl.com/11106-patterns-download>



# Liberty: block B

Note: Patterns are also printed in reverse for fusible appliqué.

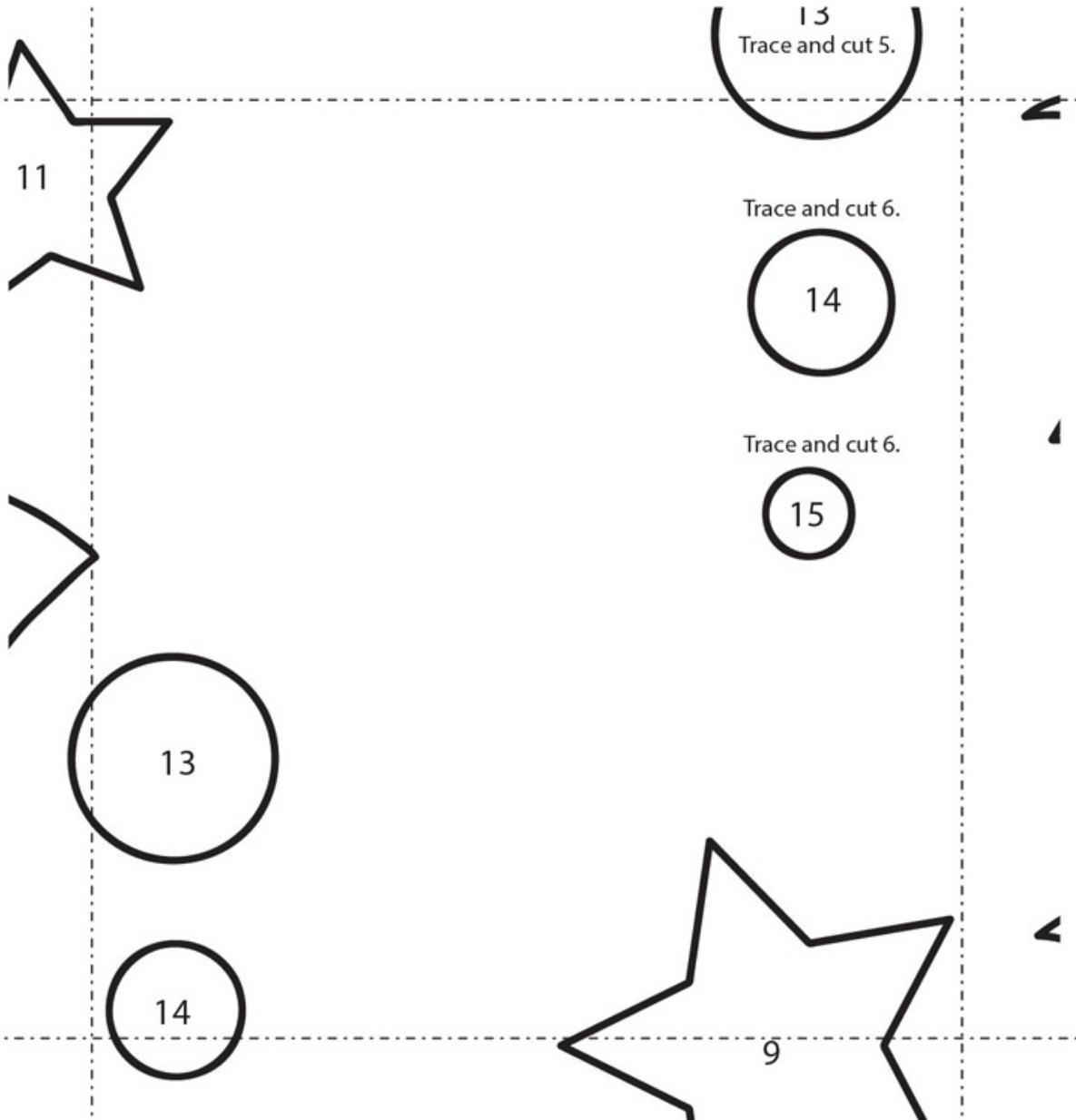
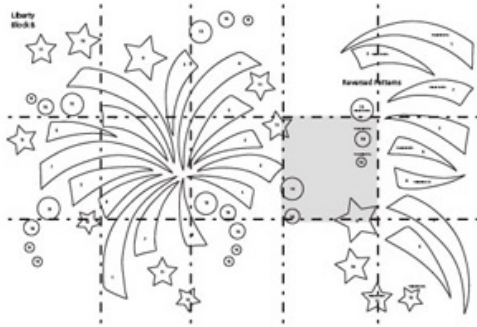
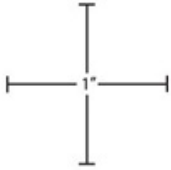

**Liberty: block B**

*Note: Patterns are also printed in reverse for fusible appliqué.*

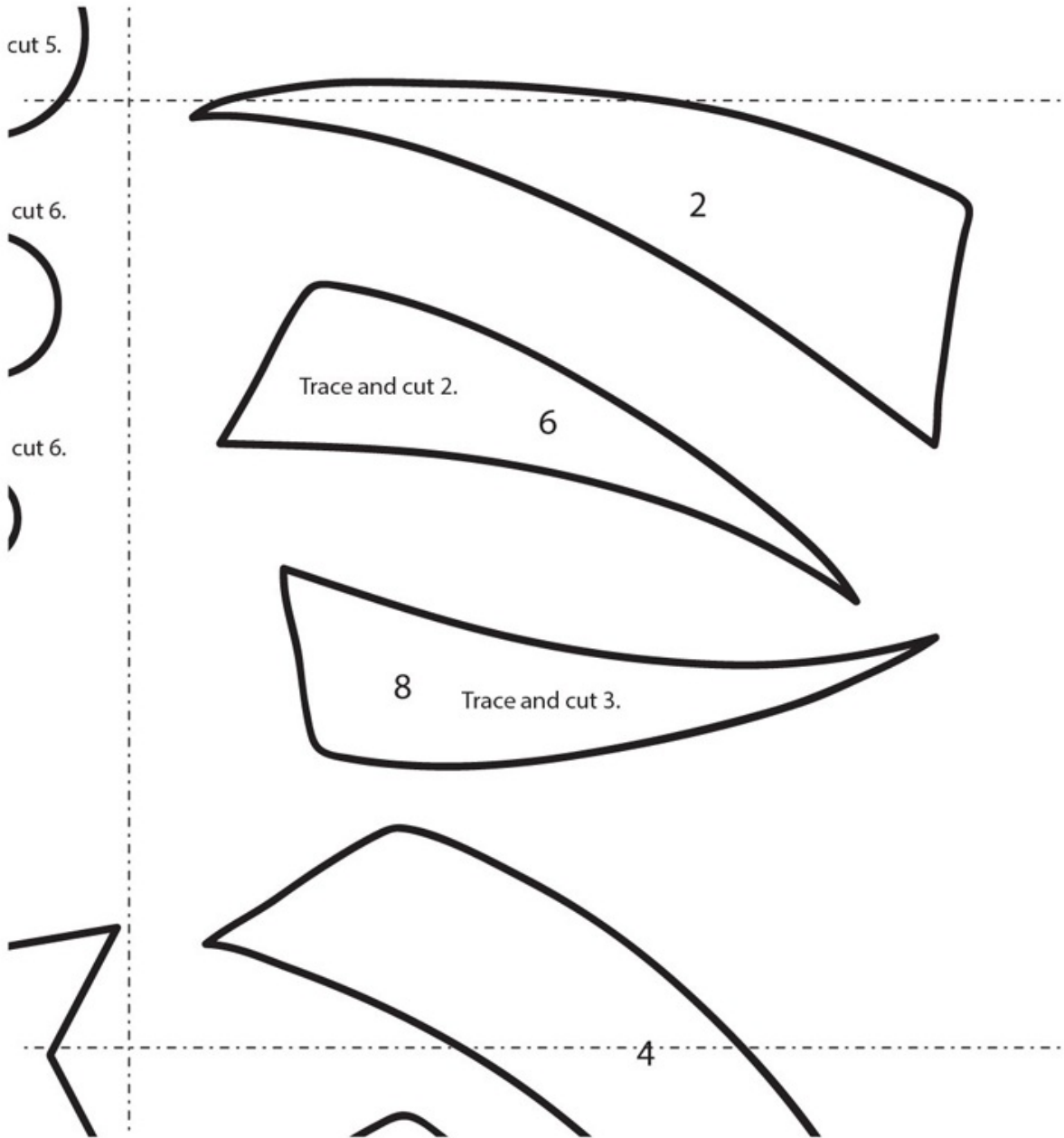
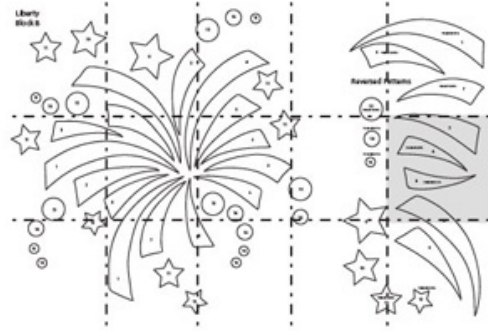
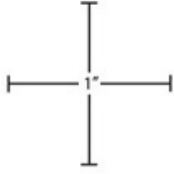

For all printable patterns or digital content: <http://tinyurl.com/11106-patterns-download>

# Liberty: block B

Note: Patterns are also printed in reverse for fusible appliqué.

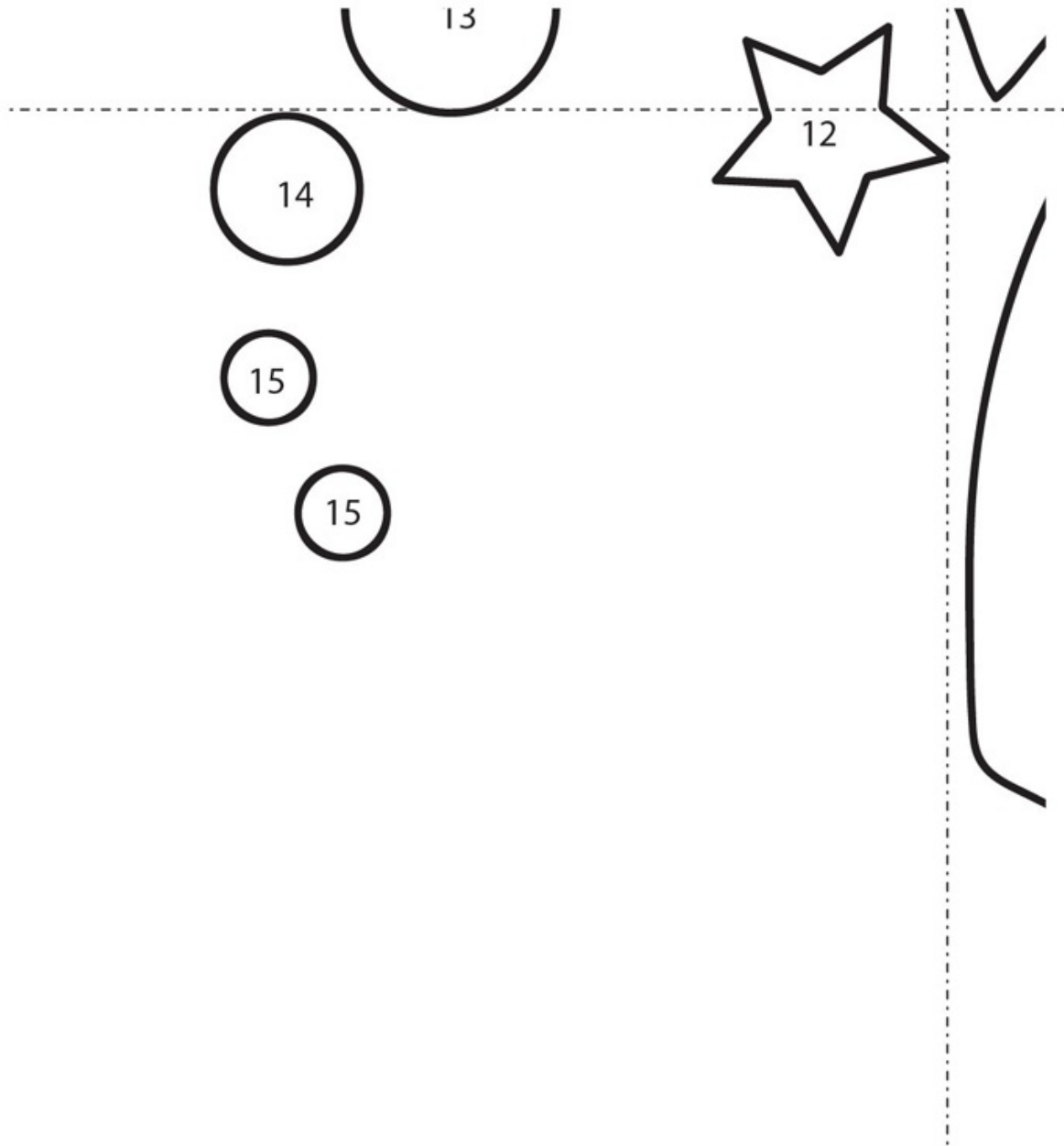
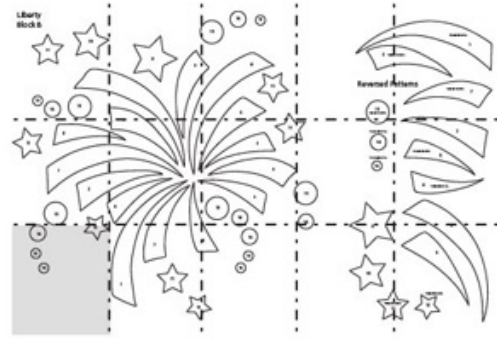
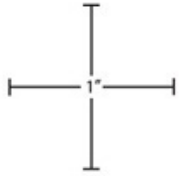

For all printable patterns or digital content: <http://tinyurl.com/11106-patterns-download>

# Liberty: block B

Note: Patterns are also printed in reverse for fusible appliqué.

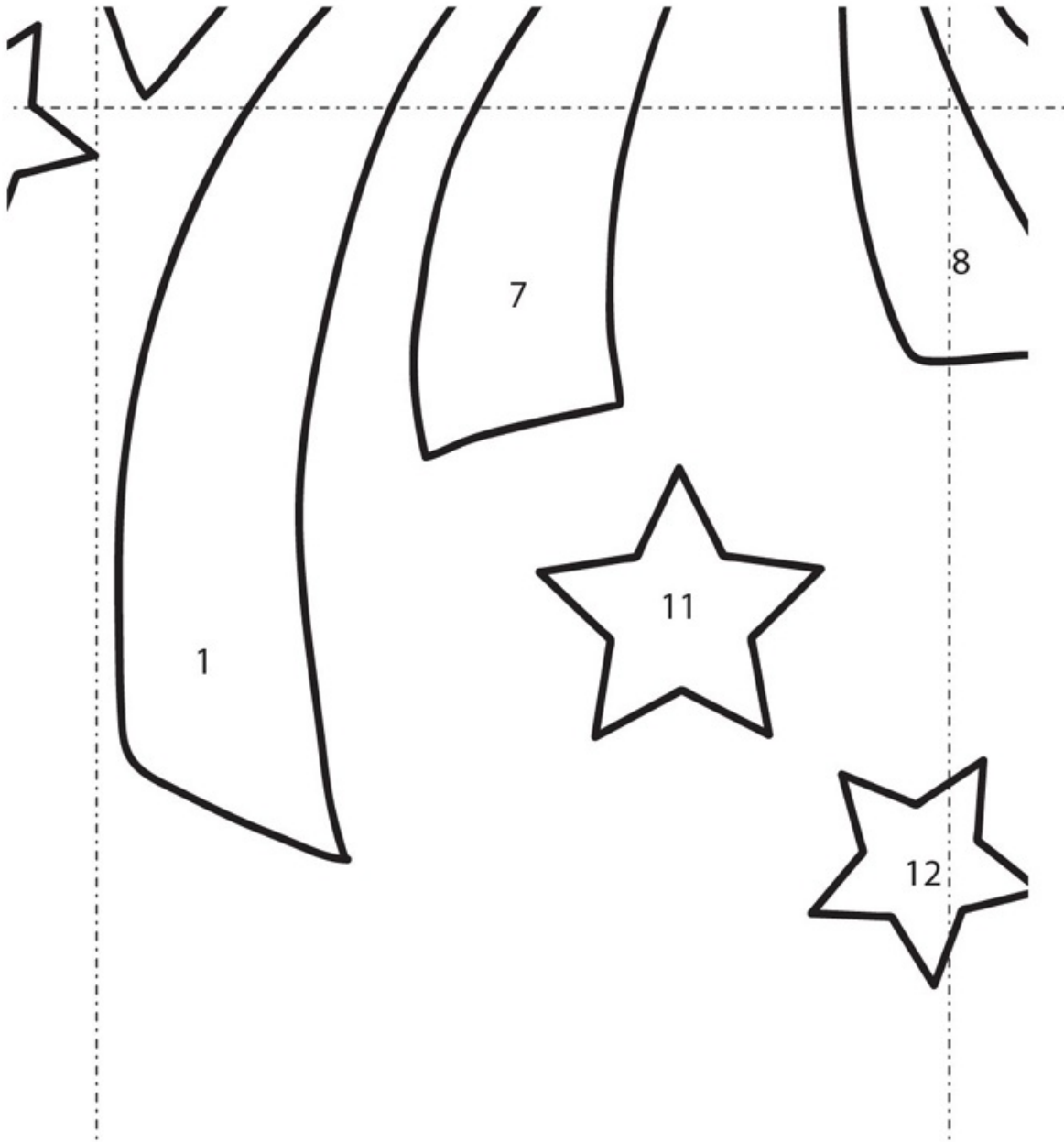
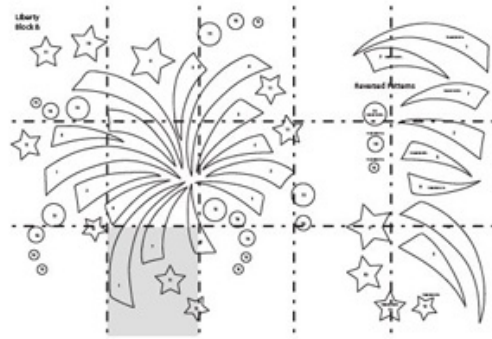
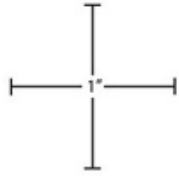

For all printable patterns or digital content: <http://tinyurl.com/11106-patterns-download>

# Liberty: block B

Note: Patterns are also printed in reverse for fusible appliqué.

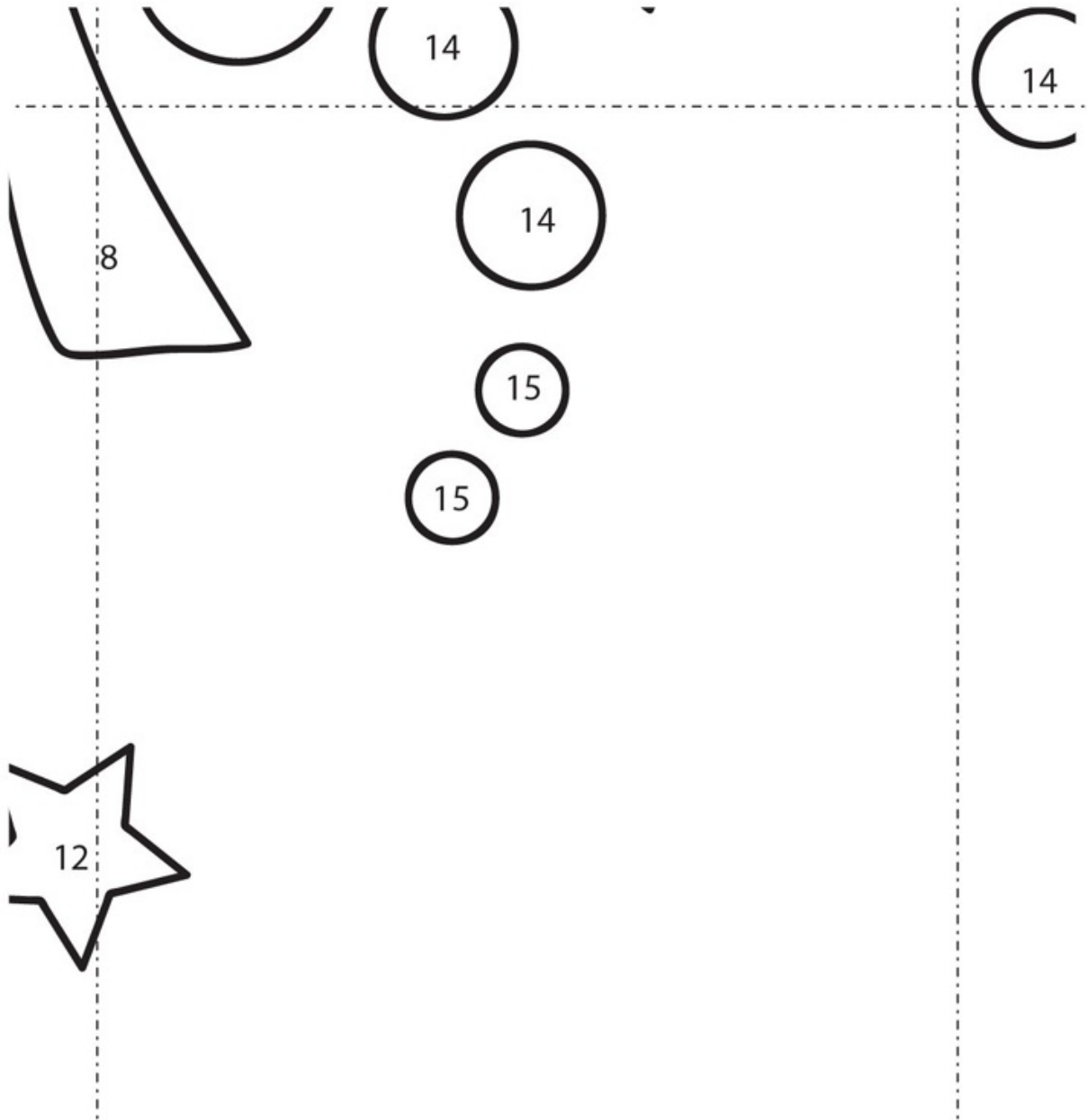
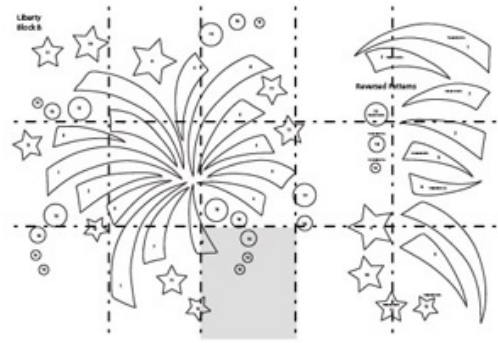
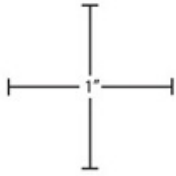



For all printable patterns or digital content: <http://tinyurl.com/11106-patterns-download>

# Liberty: block B

Note: Patterns are also printed in reverse for fusible appliqué.

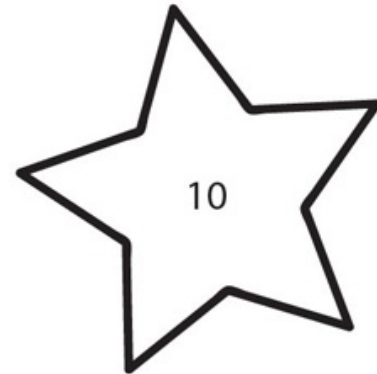
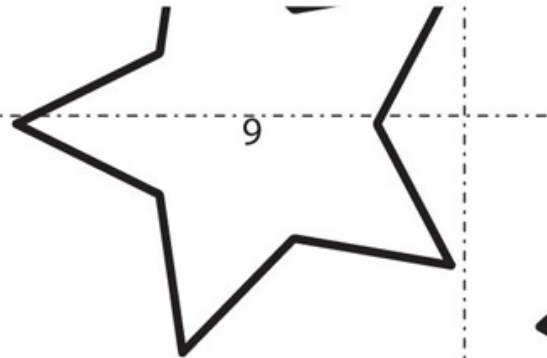
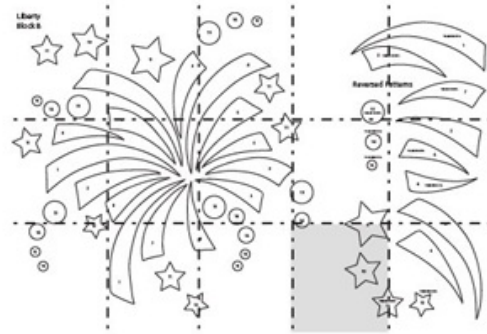
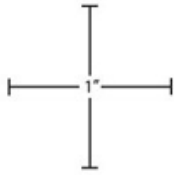

patterns-download

# Liberty: block B

Note: Patterns are also printed in reverse for fusible appliqué.

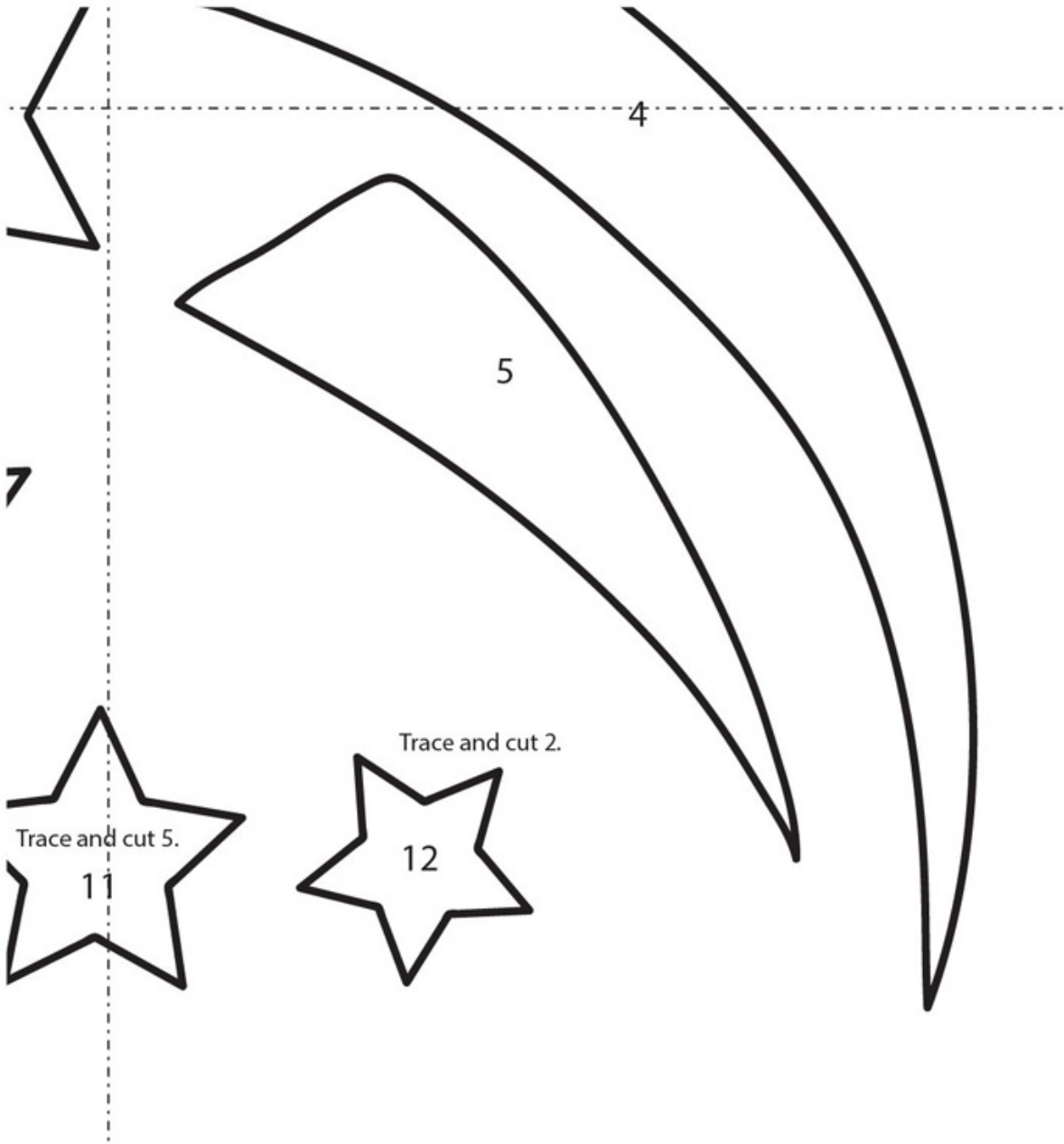
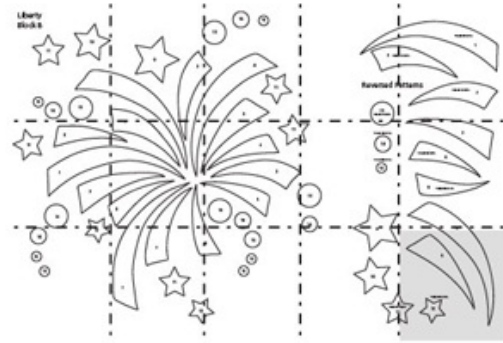
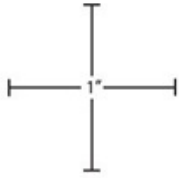

For all printable patterns or digital content: <http://tinyurl.com/11106-patterns-download>

# Liberty: block C

Note: Patterns are also printed in reverse for fusible appliqué.

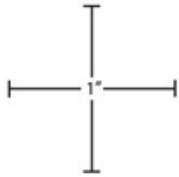

To make complete pattern, join the following pages, following the diagram for reference.

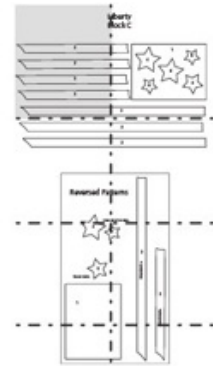

Liberty  
Block

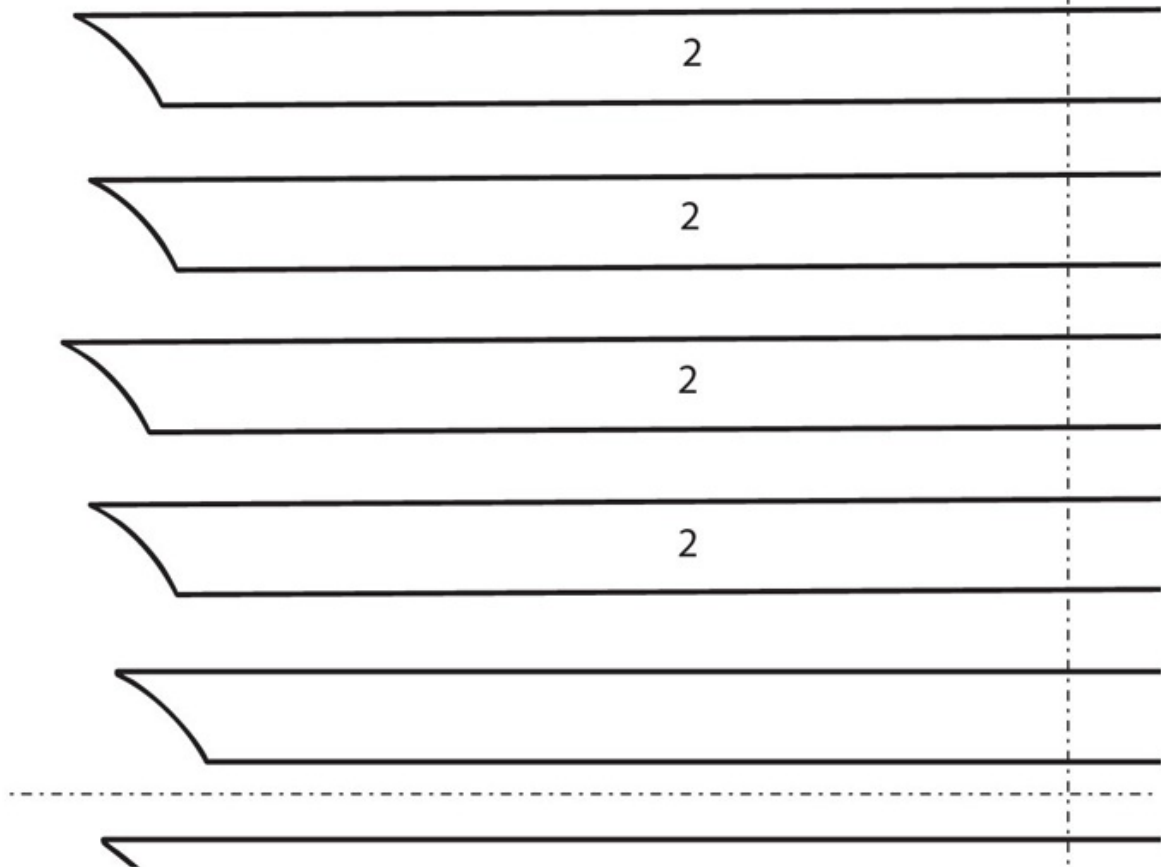

For all printable patterns or digital content: <http://tinyurl.com/11106-patterns-download>

# Liberty: block C

Note: Patterns are also printed in reverse for fusible appliqué.

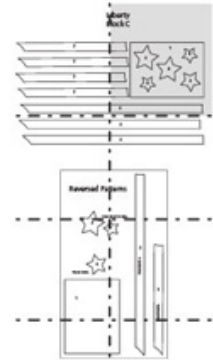
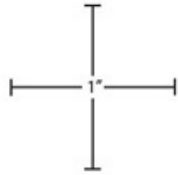

## Liberty Block C

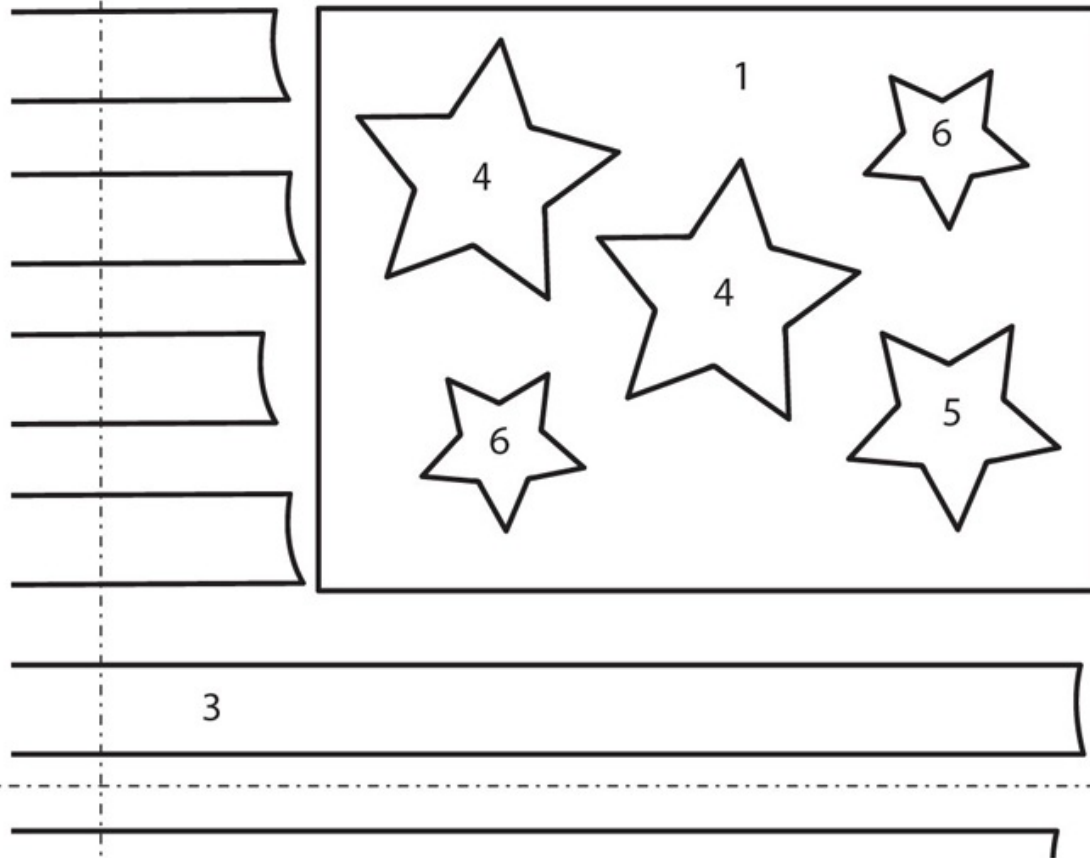



For all printable patterns or digital content: <http://tinyurl.com/11106-patterns-download>

# Liberty: block C

Note: Patterns are also printed in reverse for fusible appliqué.

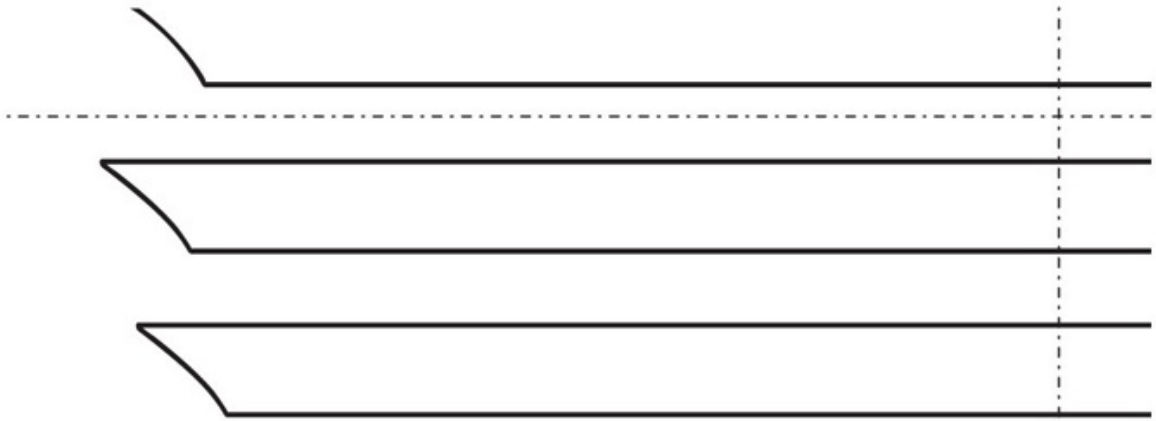
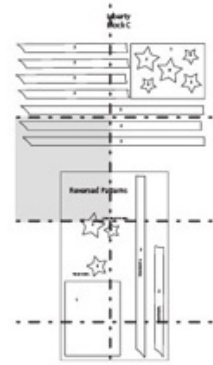
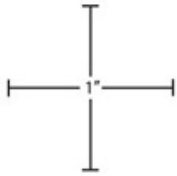

Reversed Pattern

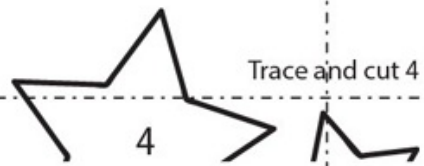

For all printable patterns or digital content: <http://tinyurl.com/11106-patterns-download>

# Liberty: block C

Note: Patterns are also printed in reverse for fusible appliqué.

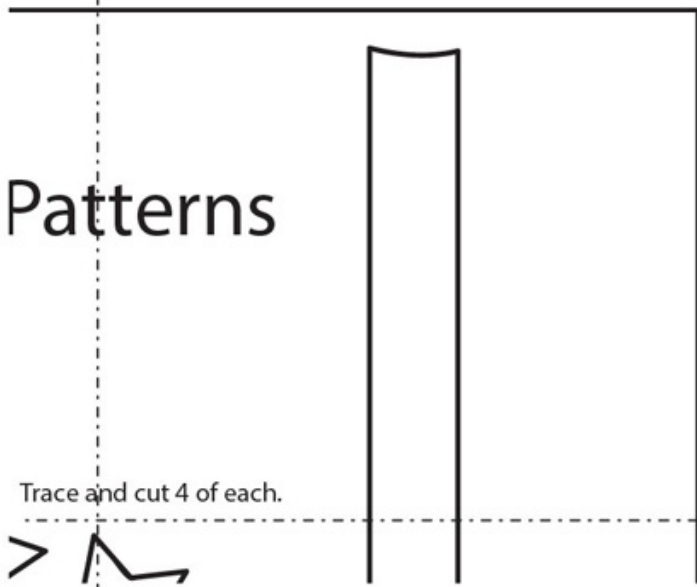
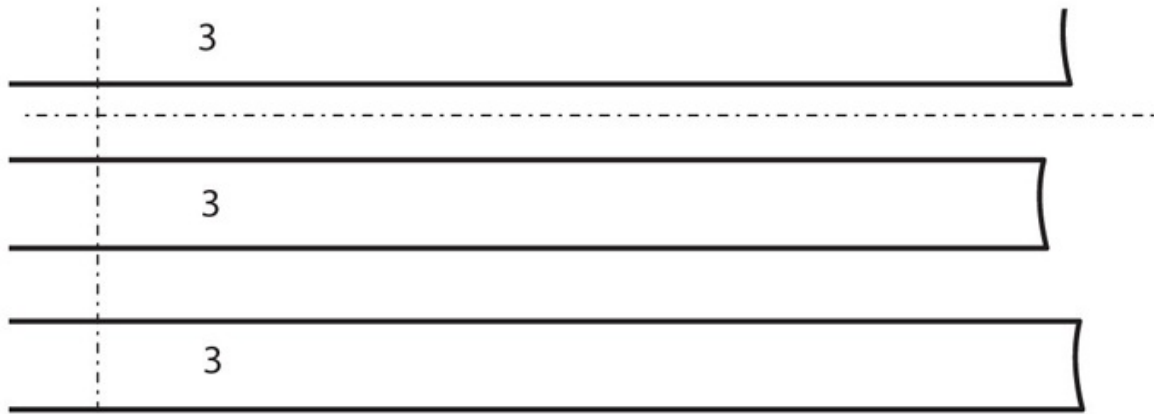
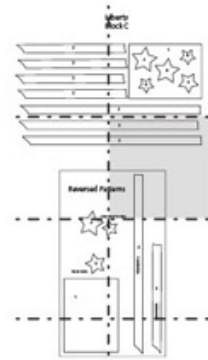
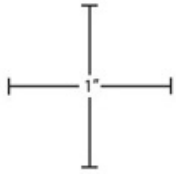

Patterns

Trace and cut 4 of each.



For all printable patterns or digital content: <http://tinyurl.com/11106-patterns-download>

# Liberty: block C

Note: Patterns are also printed in reverse for fusible appliqué.

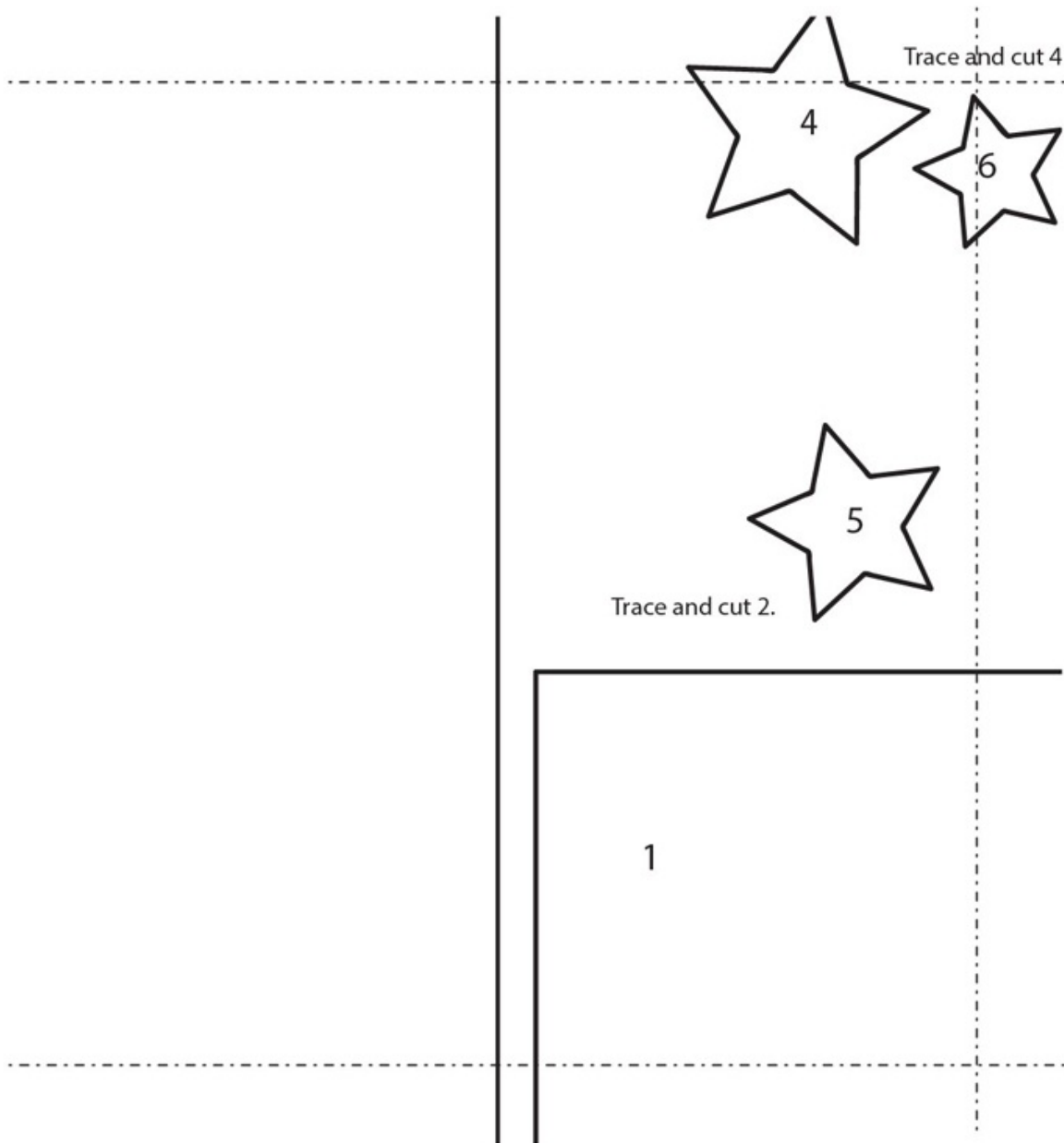
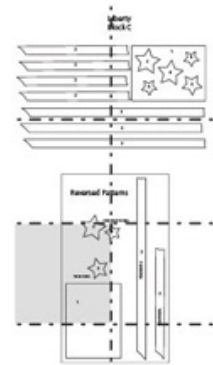
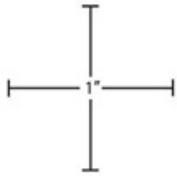

For all printable patterns or digital content: <http://tinyurl.com/11106-patterns-download>

# Liberty: block C

Note: Patterns are also printed in reverse for fusible appliqué.

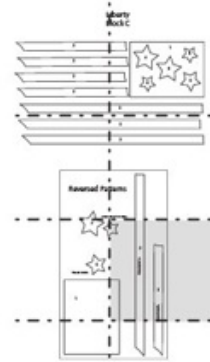
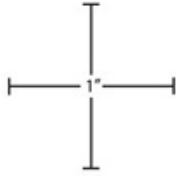

Trace and cut 4 of each.

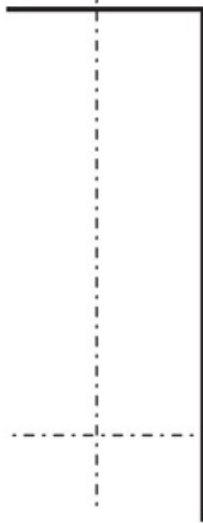

3

Trace and cut 6.



Trace and cut 8.



For all printable patterns or digital content: <http://tinyurl.com/11106-patterns-download>

### Liberty: block C

*Note: Patterns are also printed in reverse for fusible appliqué.*

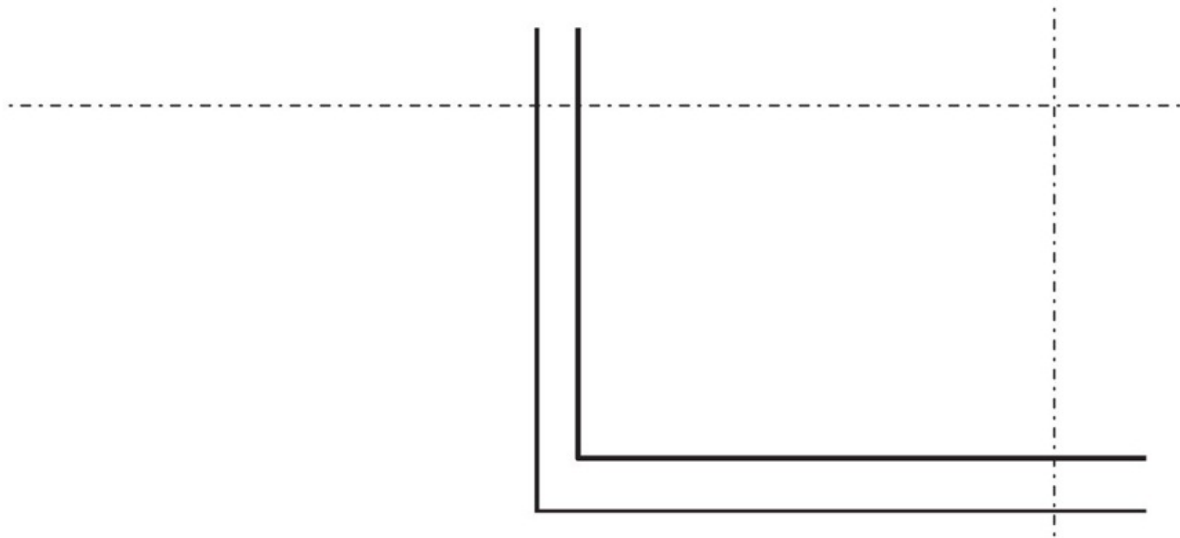
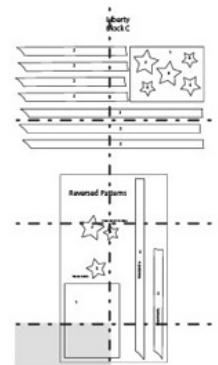
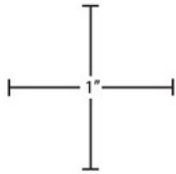

For all printable patterns or digital content: <http://tinyurl.com/11106-patterns-download>

## Liberty: block C

Note: Patterns are also printed in reverse for fusible appliqué.

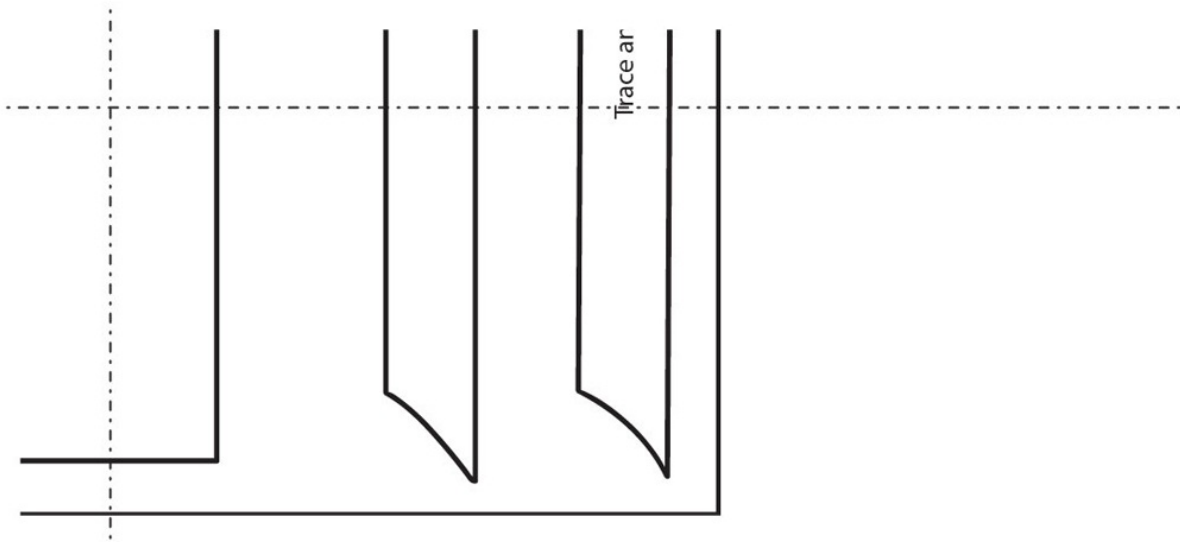
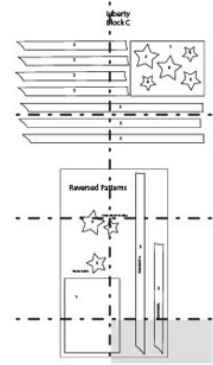
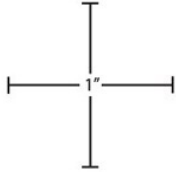

For all printable patterns or digital content: <http://tinyurl.com/11106-patterns-download>

# Liberty: block D

Note: Patterns are also printed in reverse for fusible appliqué.

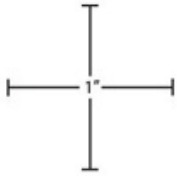

To make complete pattern, join the following pages, following the diagram for reference.

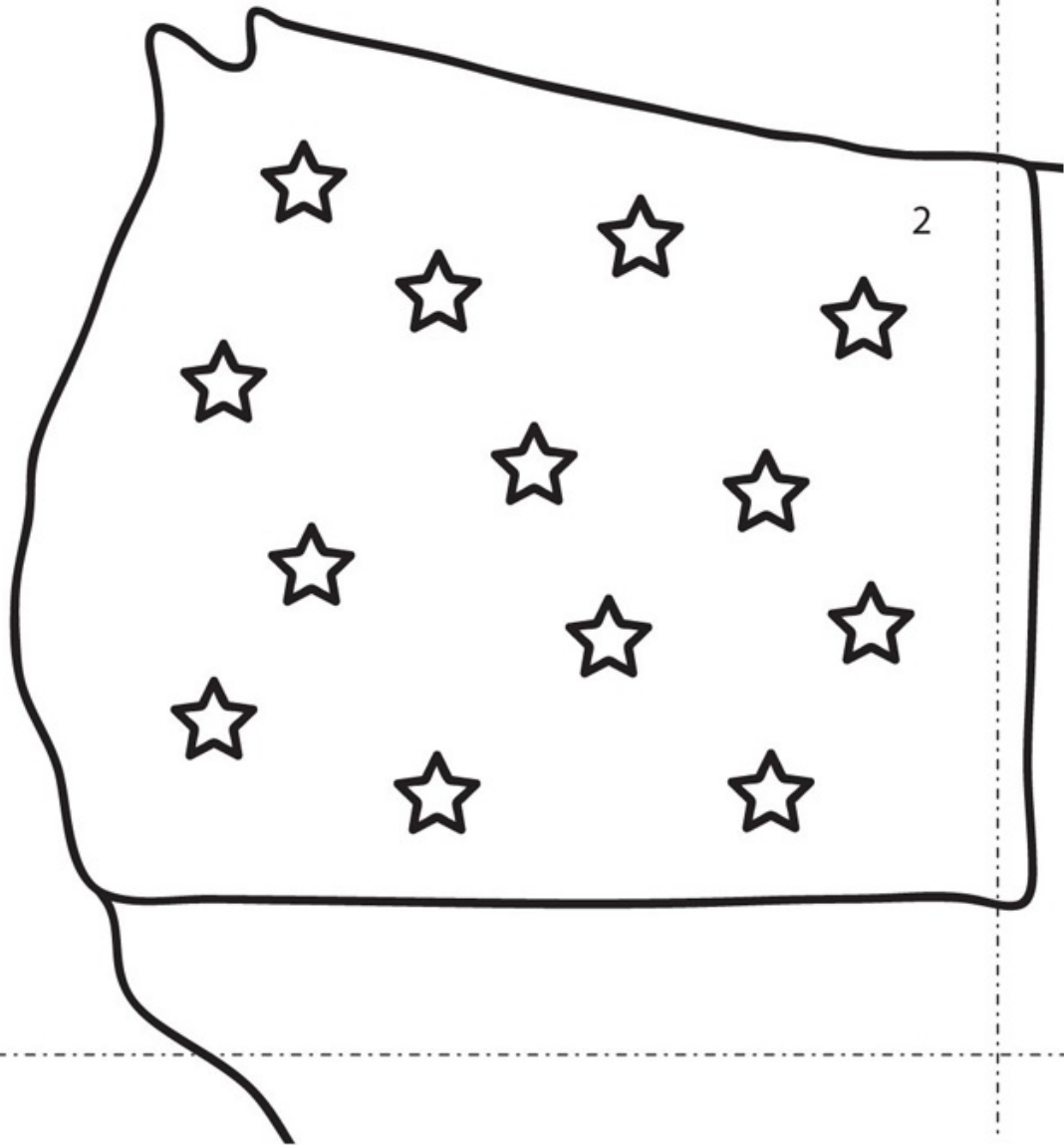

For all printable patterns or digital content: <http://tinyurl.com/11106-patterns-download>

# Liberty: block D

Note: Patterns are also printed in reverse for fusible appliqué.

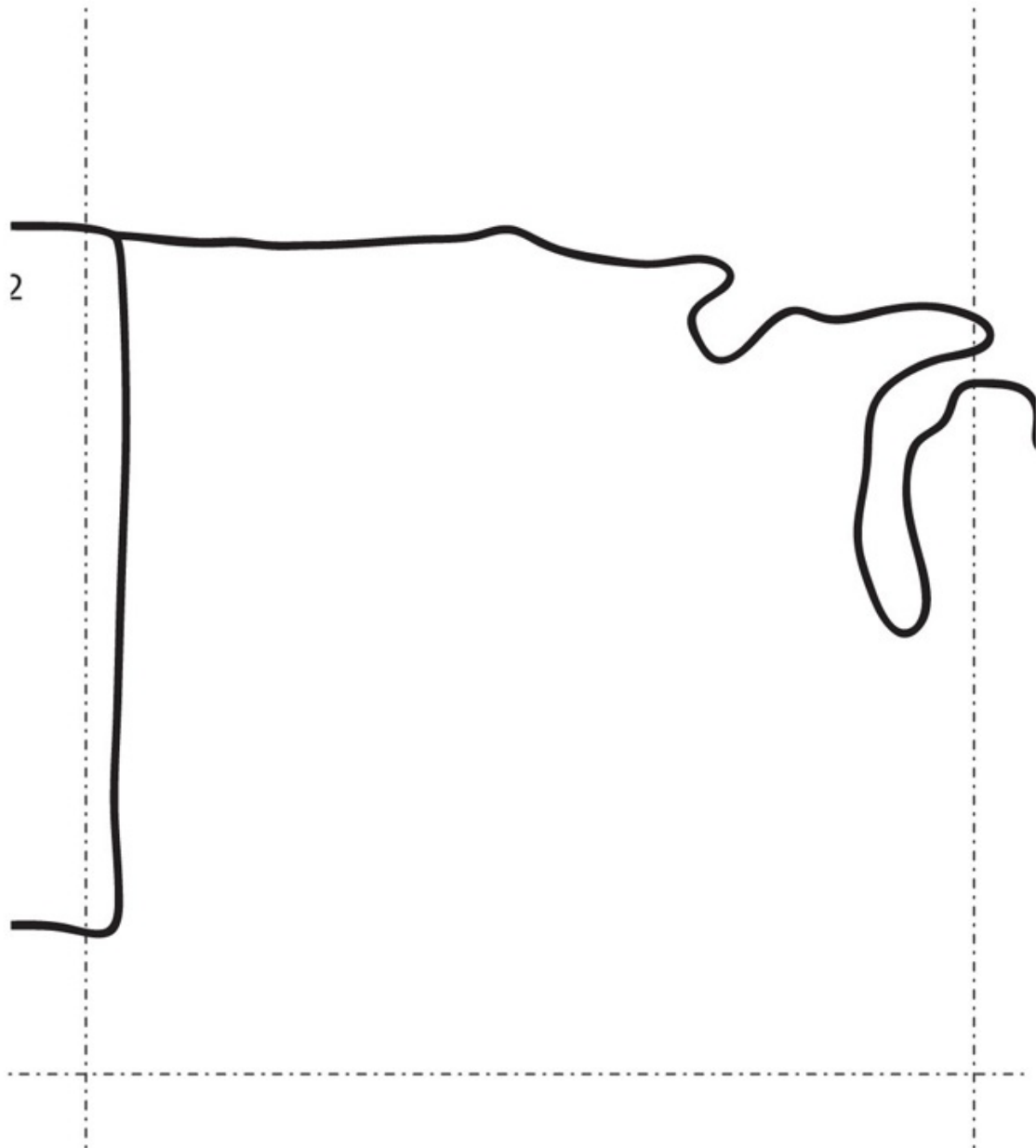
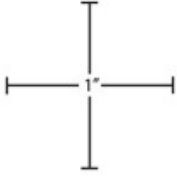

For all printable patterns or digital content: <http://tinyurl.com/11106-patterns-download>

# Liberty: block D

Note: Patterns are also printed in reverse for fusible appliqué.

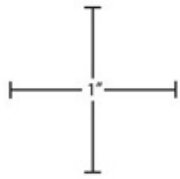

For all printable patterns or digital content: <http://tinyurl.com/11106-patterns-download>



## Liberty: block D

*Note: Patterns are also printed in reverse for fusible appliqué.*

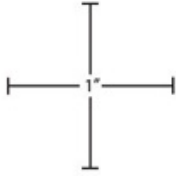

## Liberty Block D



For all printable patterns or digital content: <http://tinyurl.com/11106-patterns-download>

## Liberty: block D

Note: Patterns are also printed in reverse for fusible appliqué.

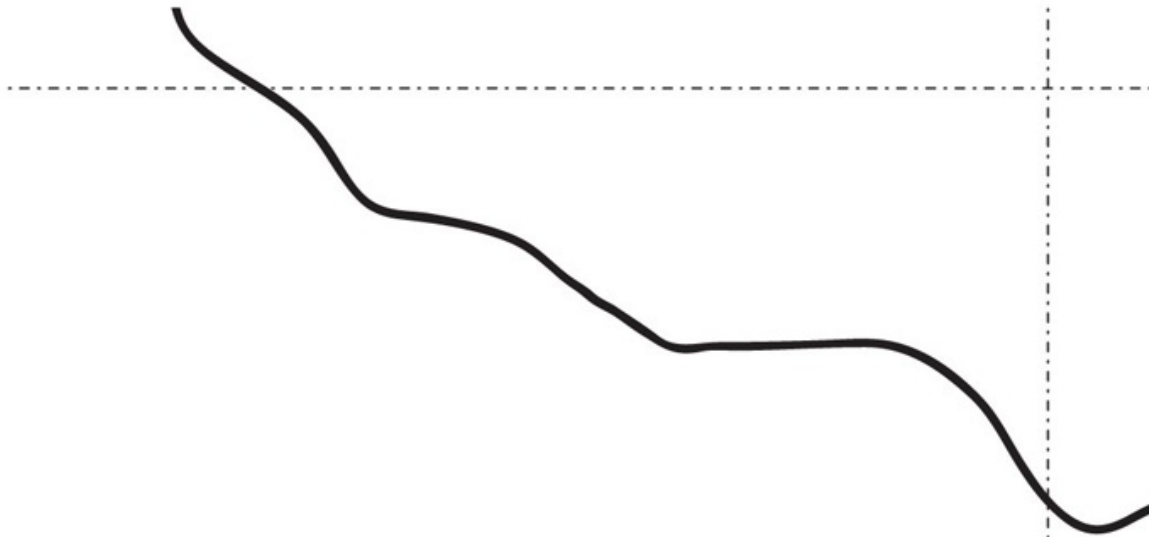
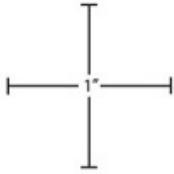

## Reversed Patterns



Trace and cut 1.

For all printable patterns or digital content: <http://tinyurl.com/11106-patterns-download>

**Liberty: block D**

*Note: Patterns are also printed in reverse for fusible appliqué.*

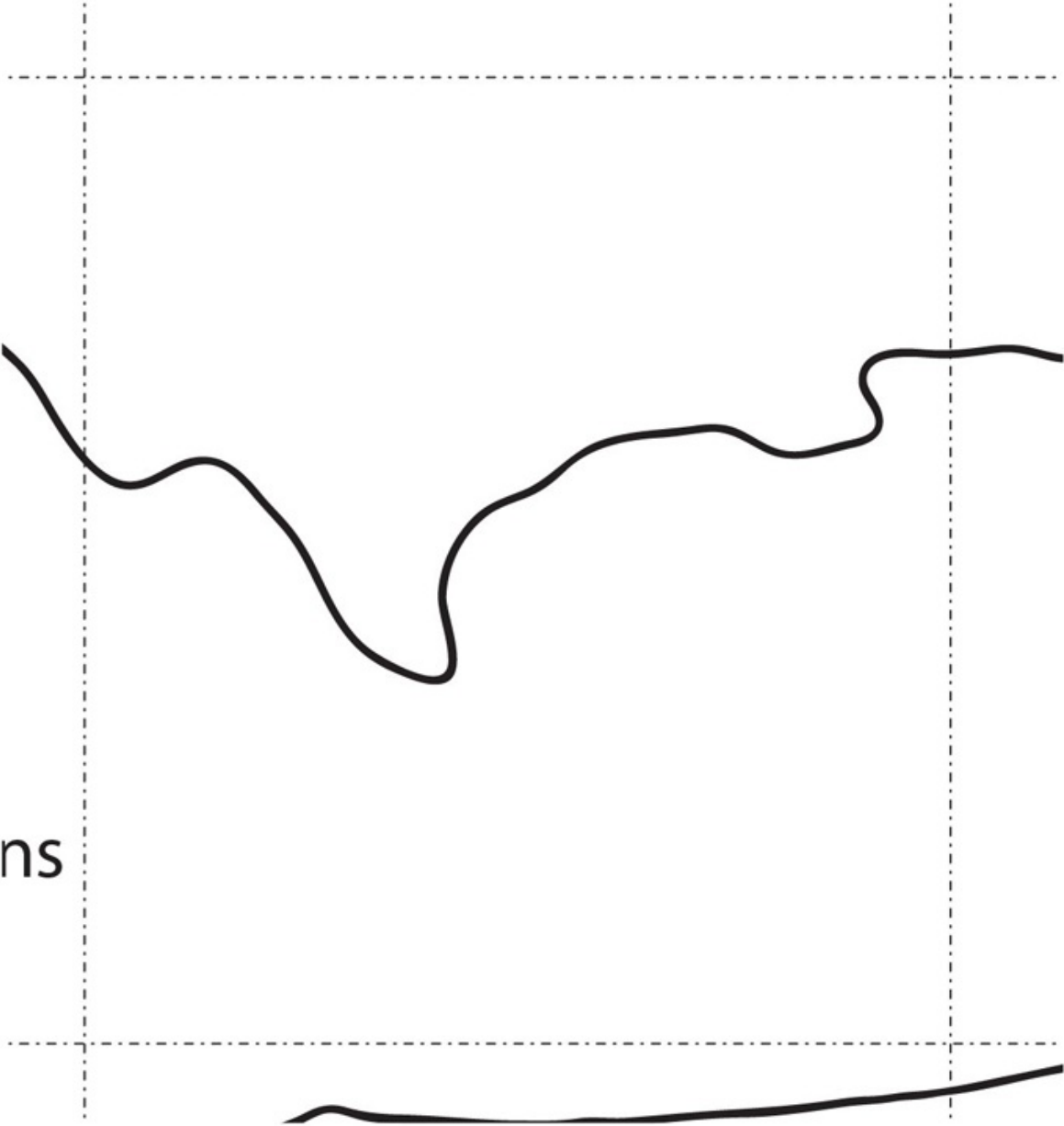
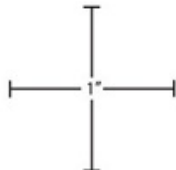

For all printable patterns or digital content: <http://tinyurl.com/11106-patterns-download>

# Liberty: block D

Note: Patterns are also printed in reverse for fusible appliqué.

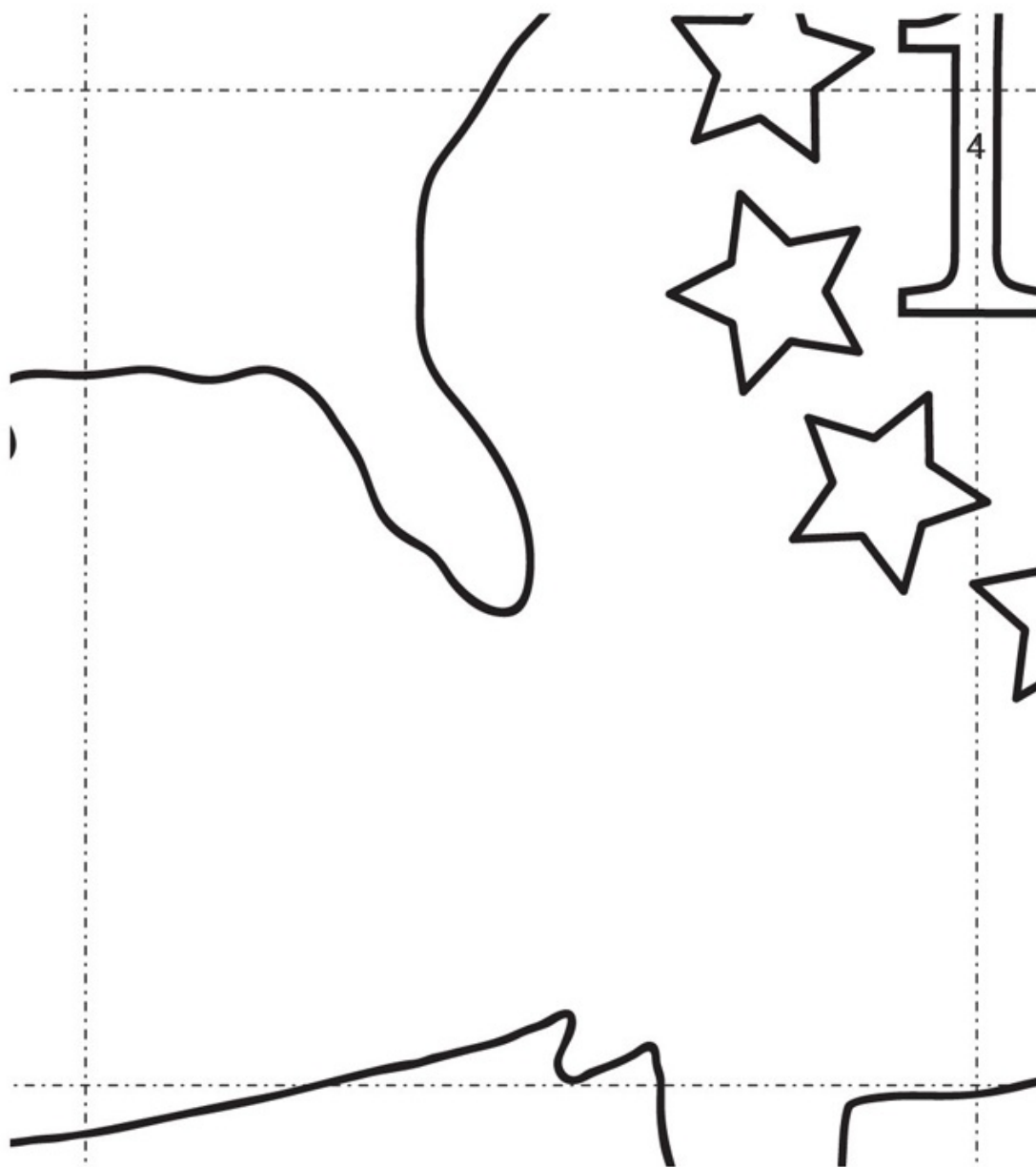
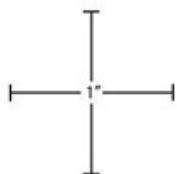

For all printable patterns or digital content: <http://tinyurl.com/11106-patterns-download>



# Liberty: block D

Note: Patterns are also printed in reverse for fusible appliqué.

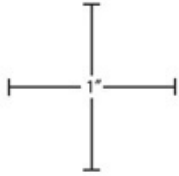

For all printable patterns or digital content: <http://tinyurl.com/11106-patterns-download>

# Liberty: block D

Note: Patterns are also printed in reverse for fusible appliqué.

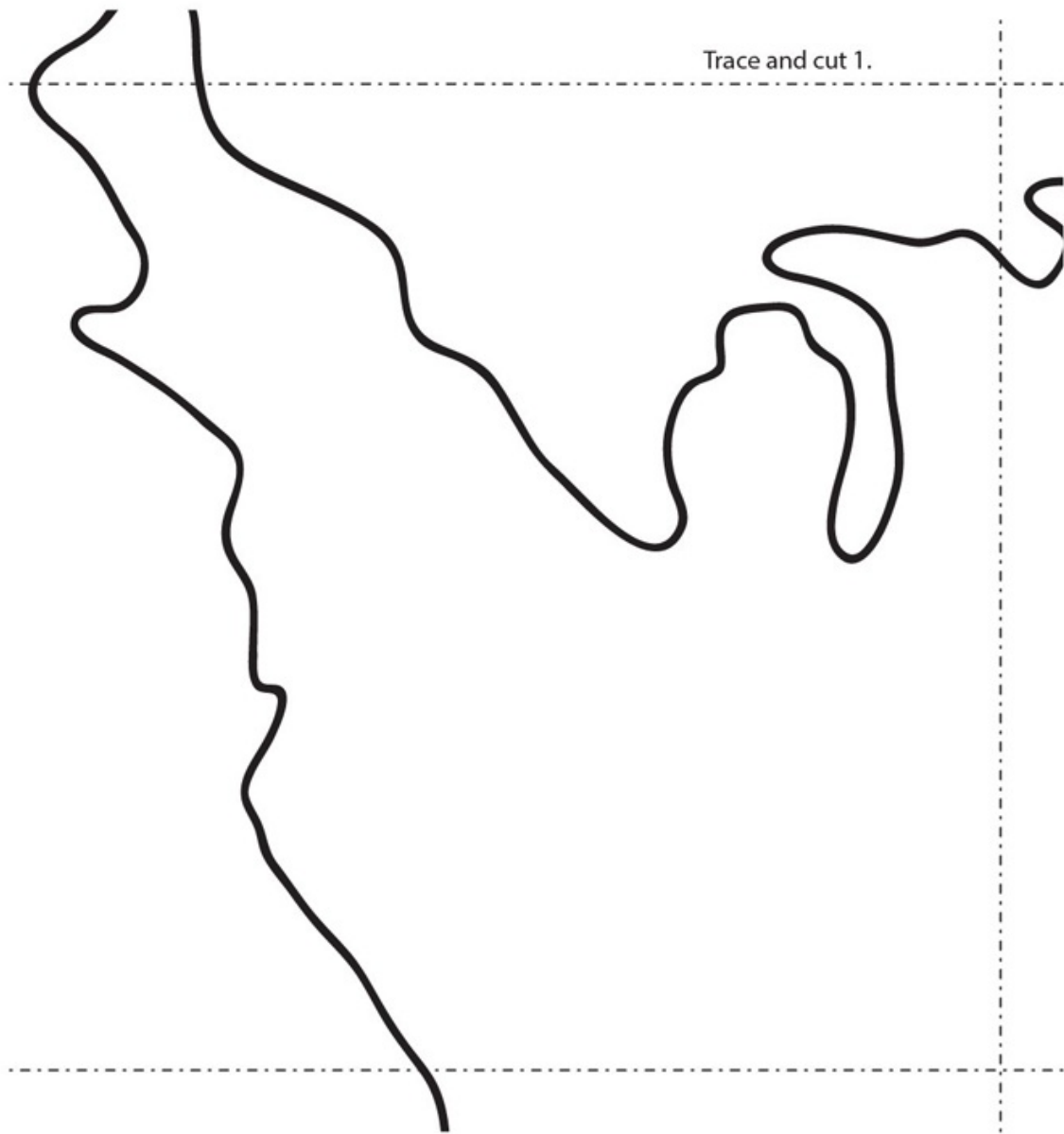
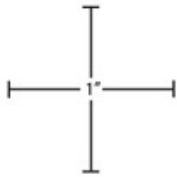

For all printable patterns or digital content: <http://tinyurl.com/11106-patterns-download>

# Liberty: block D

Note: Patterns are also printed in reverse for fusible appliqué.

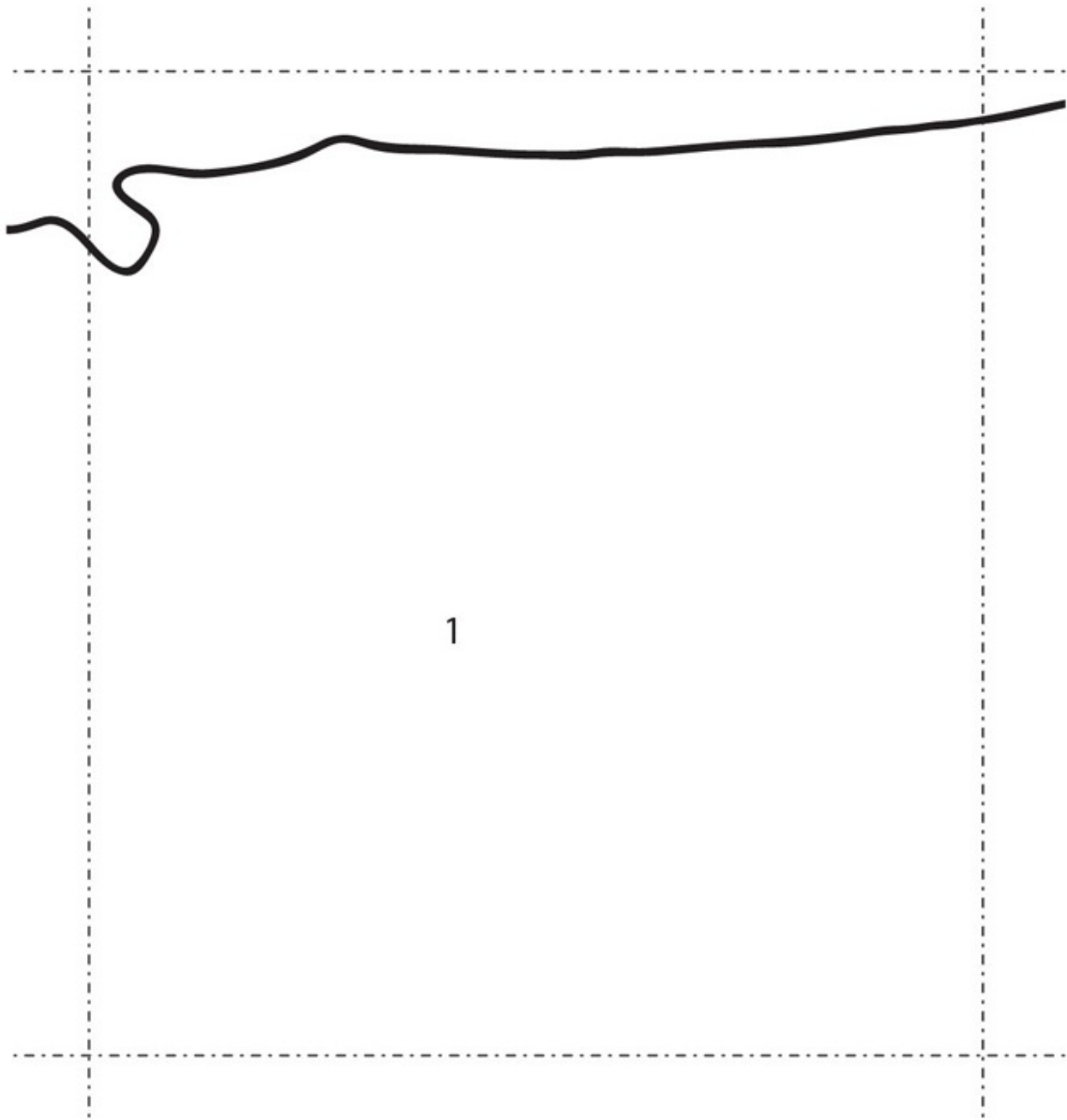
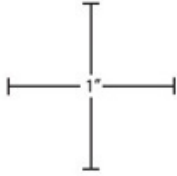

For all printable patterns or digital content: <http://tinyurl.com/11106-patterns-download>

# Liberty: block D

Note: Patterns are also printed in reverse for fusible appliqué.

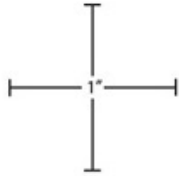

For all printable patterns or digital content: <http://tinyurl.com/11106-patterns-download>



# Liberty: block D

Note: Patterns are also printed in reverse for fusible appliqué.

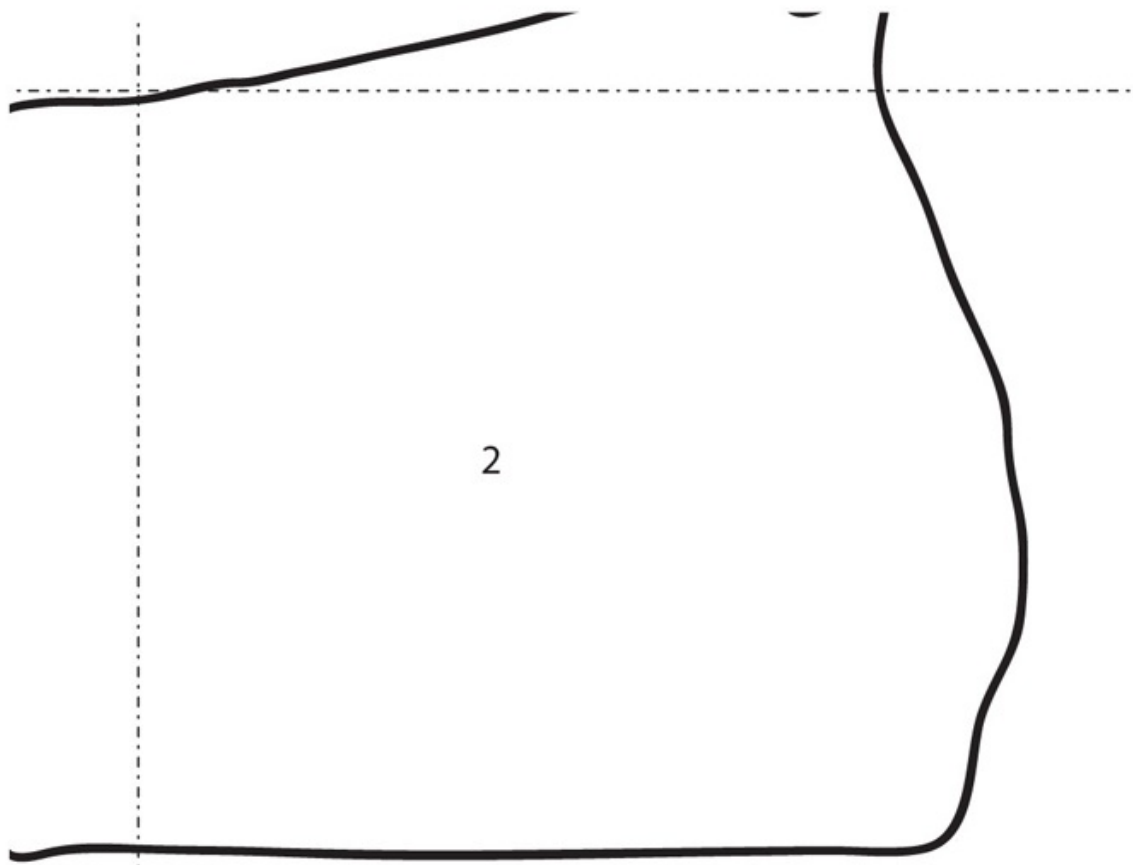
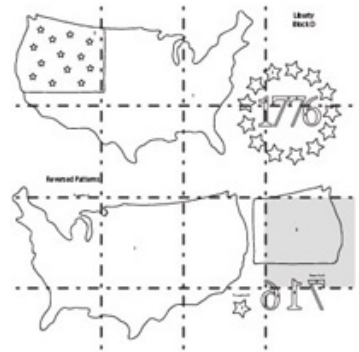
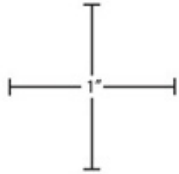

2

Trace and cut 2.

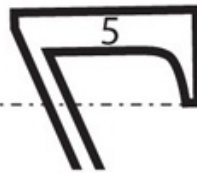

For all printable patterns or digital content: <http://tinyurl.com/11106-patterns-download>

### Liberty: block D

*Note: Patterns are also printed in reverse for fusible appliqué.*

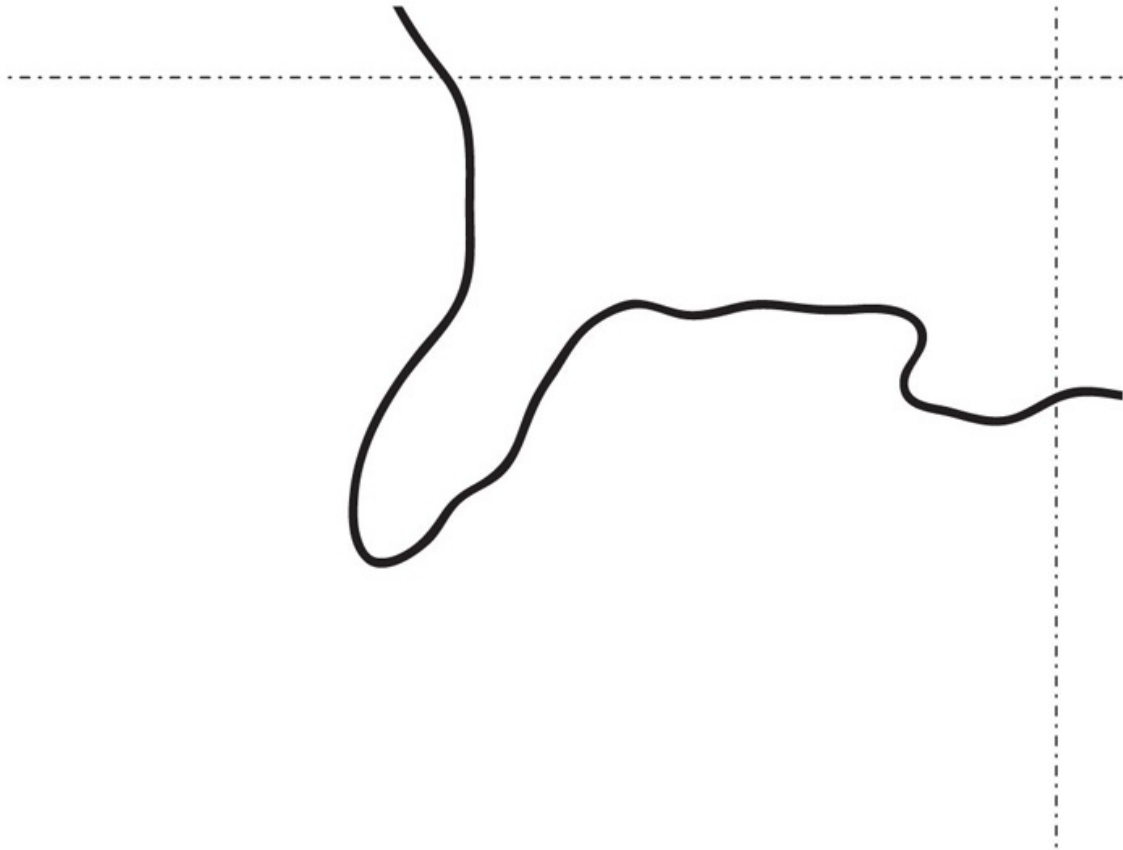
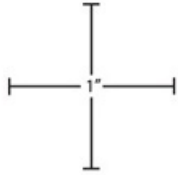

For all printable patterns or digital content: <http://tinyurl.com/11106-patterns-download>

### Liberty: block D

*Note: Patterns are also printed in reverse for fusible appliqué.*

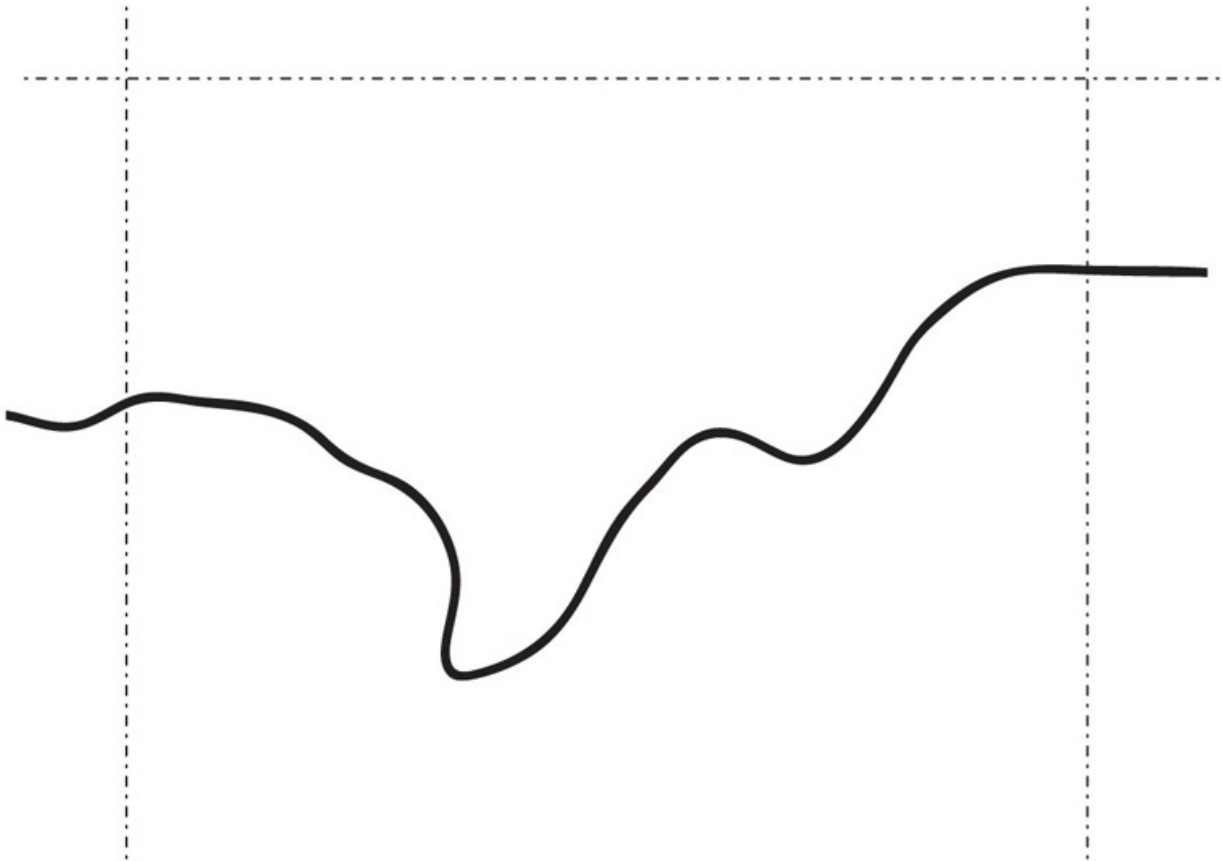
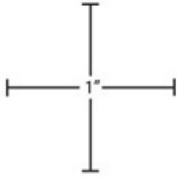

For all printable patterns or digital content: <http://tinyurl.com/11106-patterns-download>

### Liberty: block D

*Note: Patterns are also printed in reverse for fusible appliqué.*

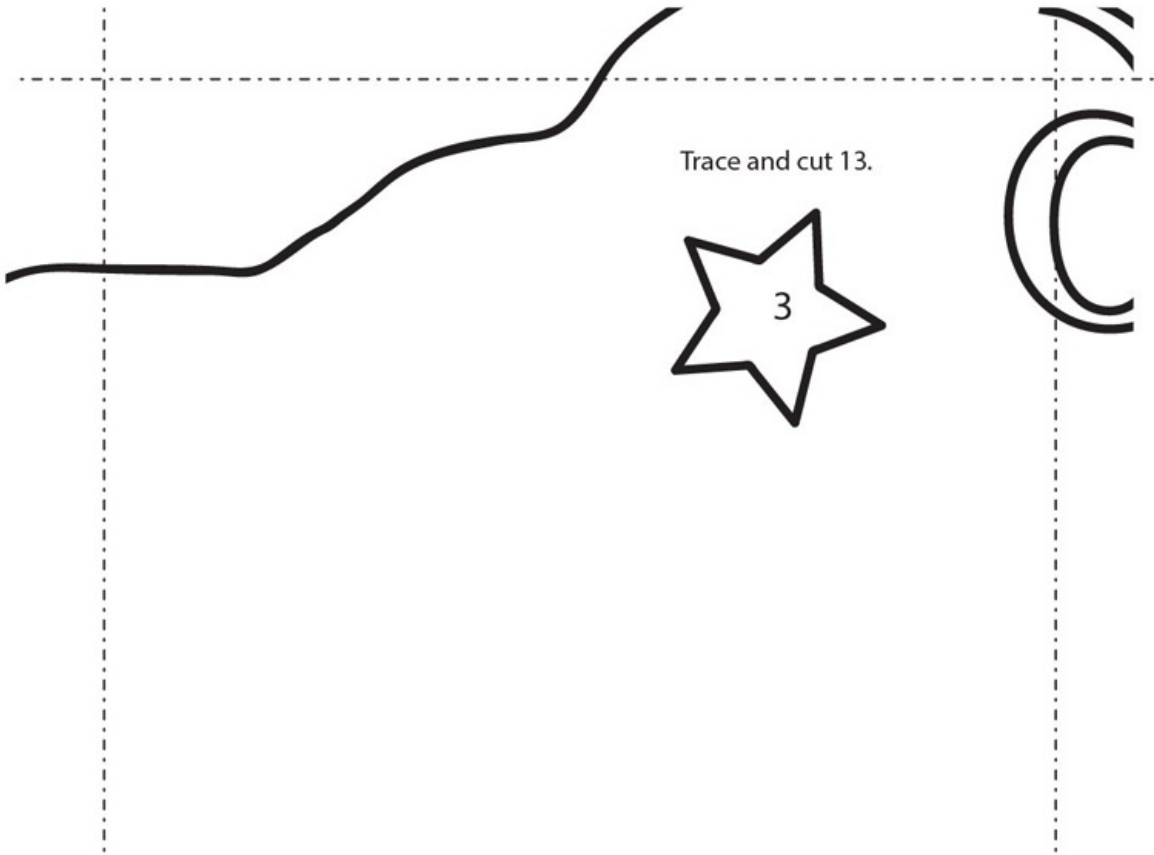
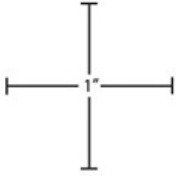

For all printable patterns or digital content: <http://tinyurl.com/11106-patterns-download>

## Liberty: block D

*Note: Patterns are also printed in reverse for fusible appliqué.*

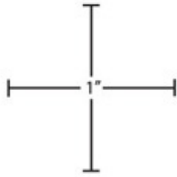

For all printable patterns or digital content: <http://tinyurl.com/11106-patterns-download>

## Thankful: block A

Note: Patterns are also printed in reverse for fusible appliqué.

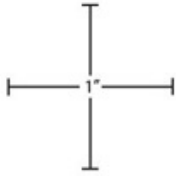

To make complete pattern, join the following pages, following the diagram for reference.

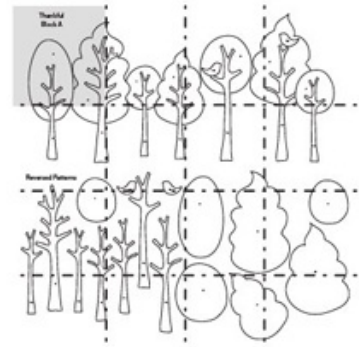

# Thankful Block A

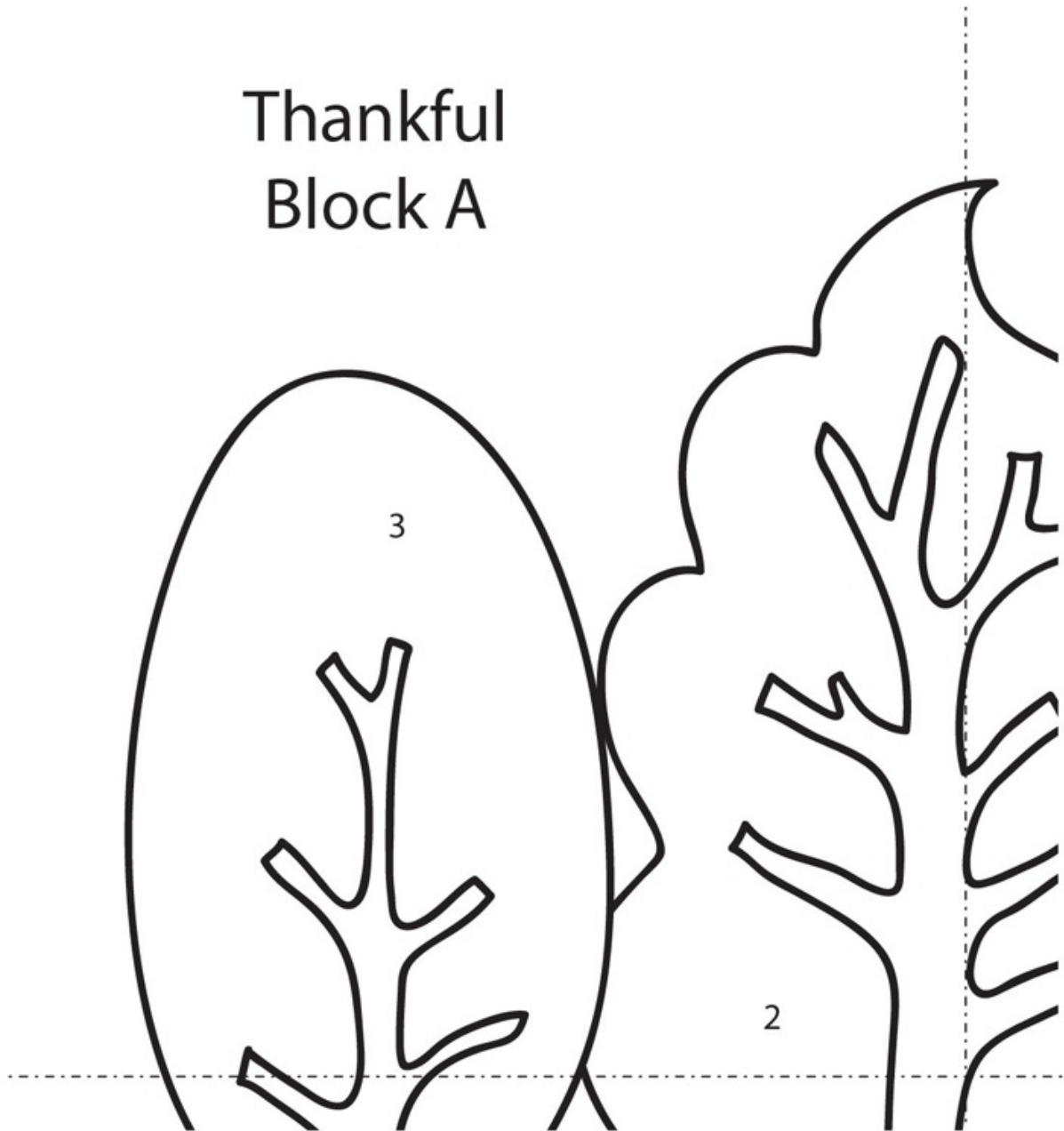

For all printable patterns or digital content: <http://tinyurl.com/11106-patterns-download>

**Thankful: block A**

*Note: Patterns are also printed in reverse for fusible appliqué.*

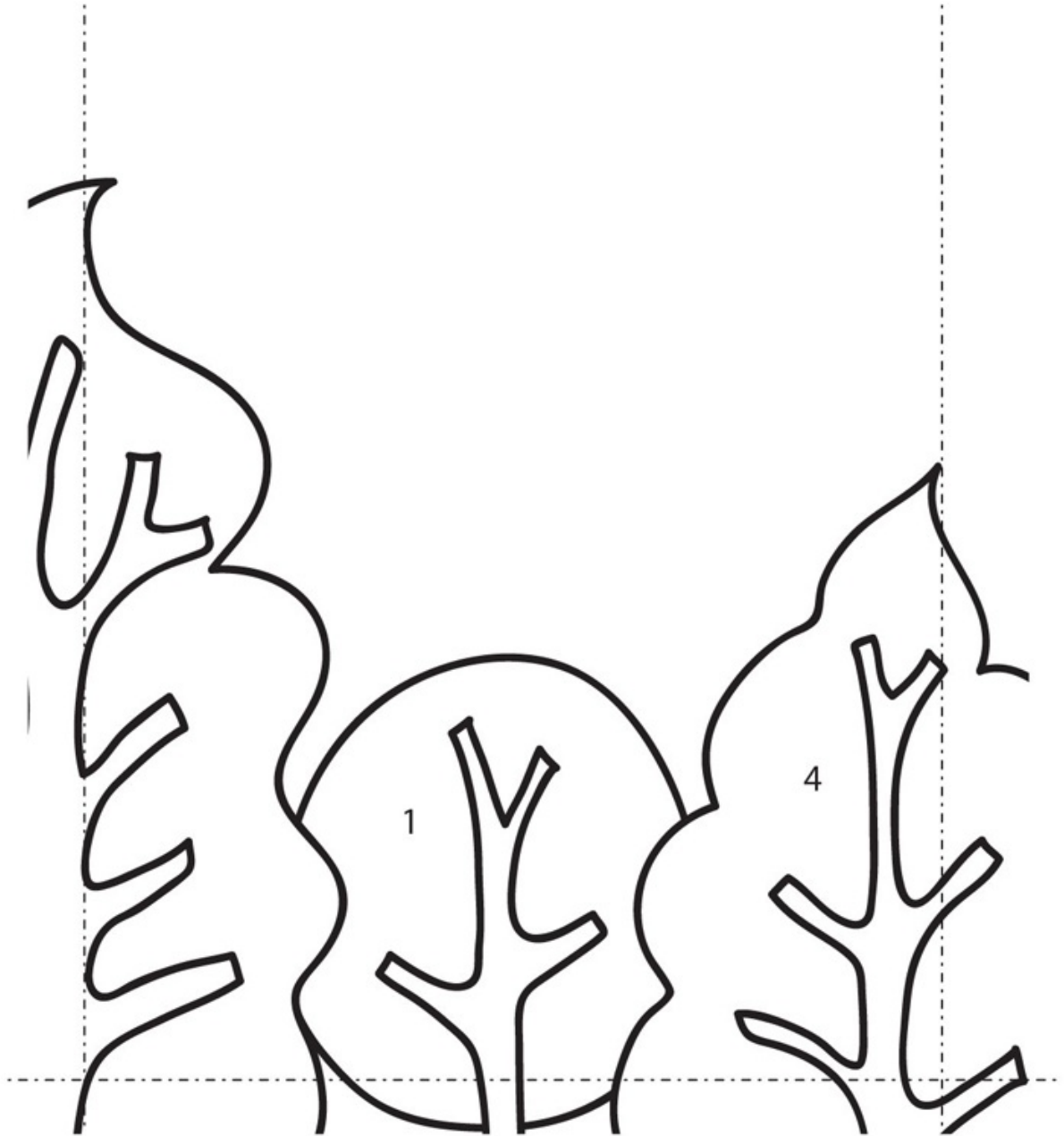
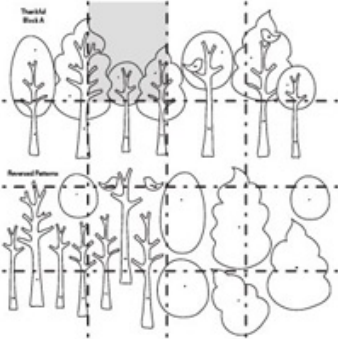
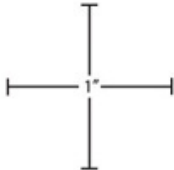



For all printable patterns or digital content: <http://tinyurl.com/11106-patterns-download>

**Thankful: block A**

*Note: Patterns are also printed in reverse for fusible appliqué.*

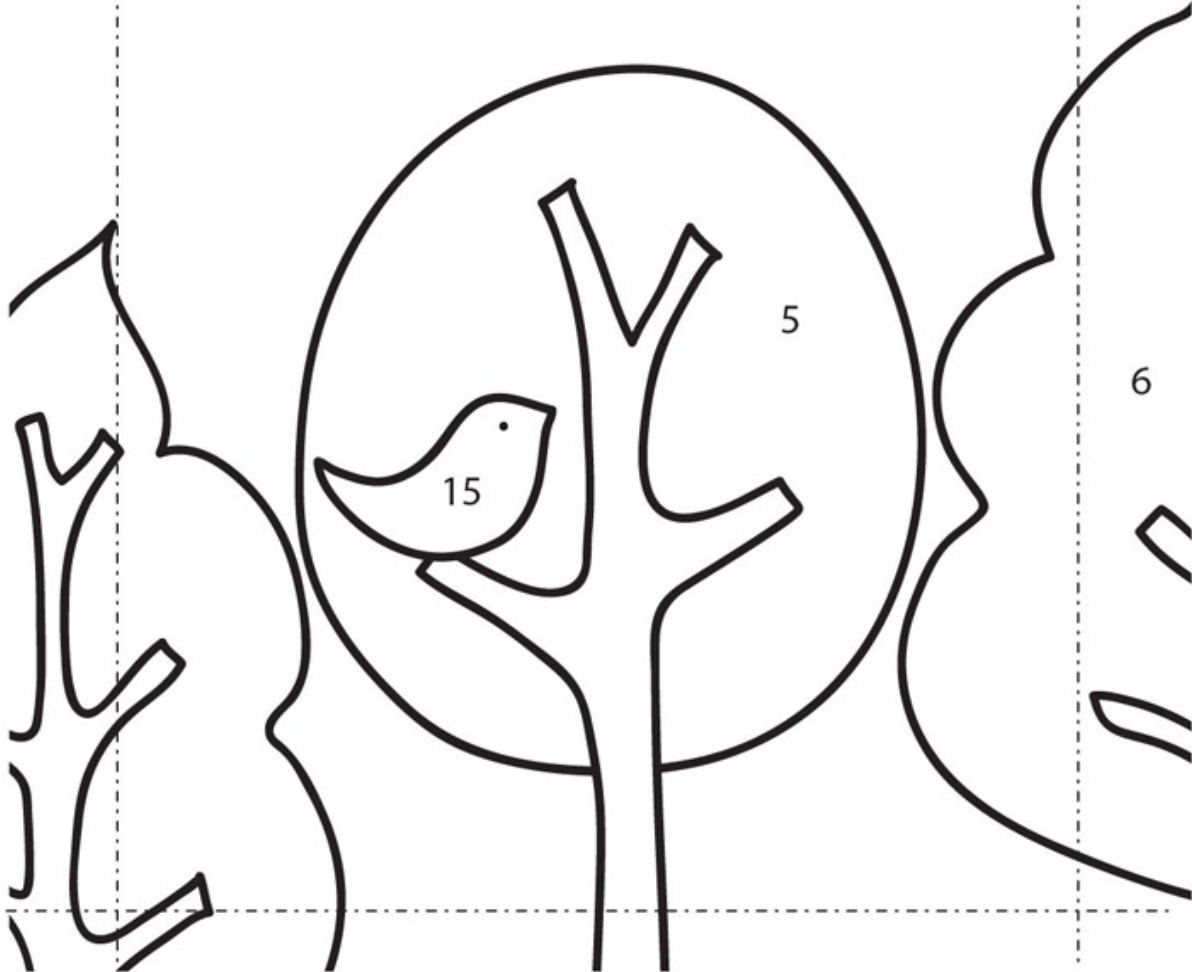
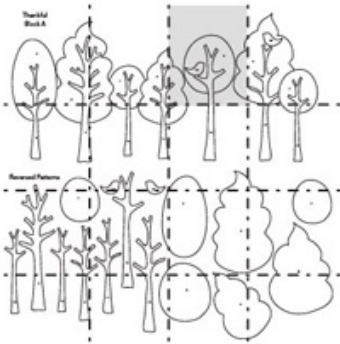
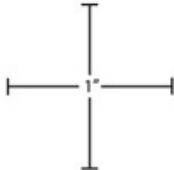

For all printable patterns or digital content: <http://tinyurl.com/11106-patterns-download>

## Thankful: block A

Note: Patterns are also printed in reverse for fusible appliqué.

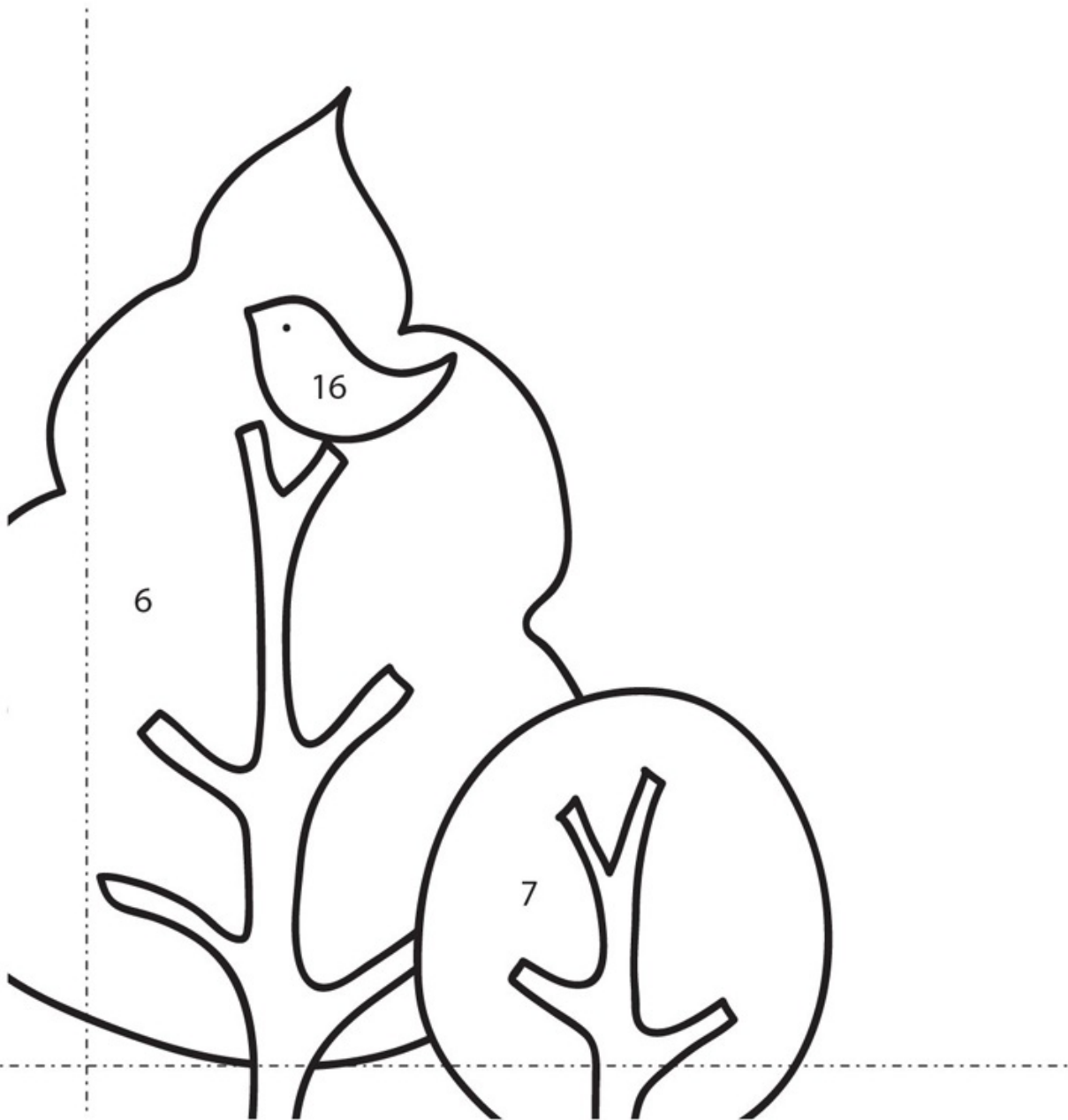
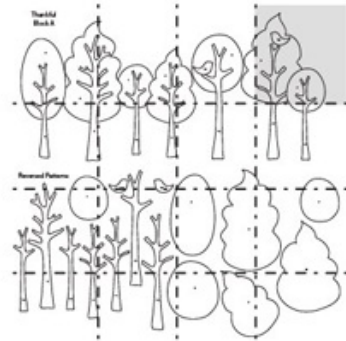
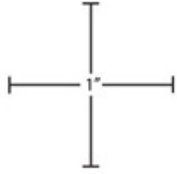

For all printable patterns or digital content: <http://tinyurl.com/11106-patterns-download>

# Thankful: block A

Note: Patterns are also printed in reverse for fusible appliqué.

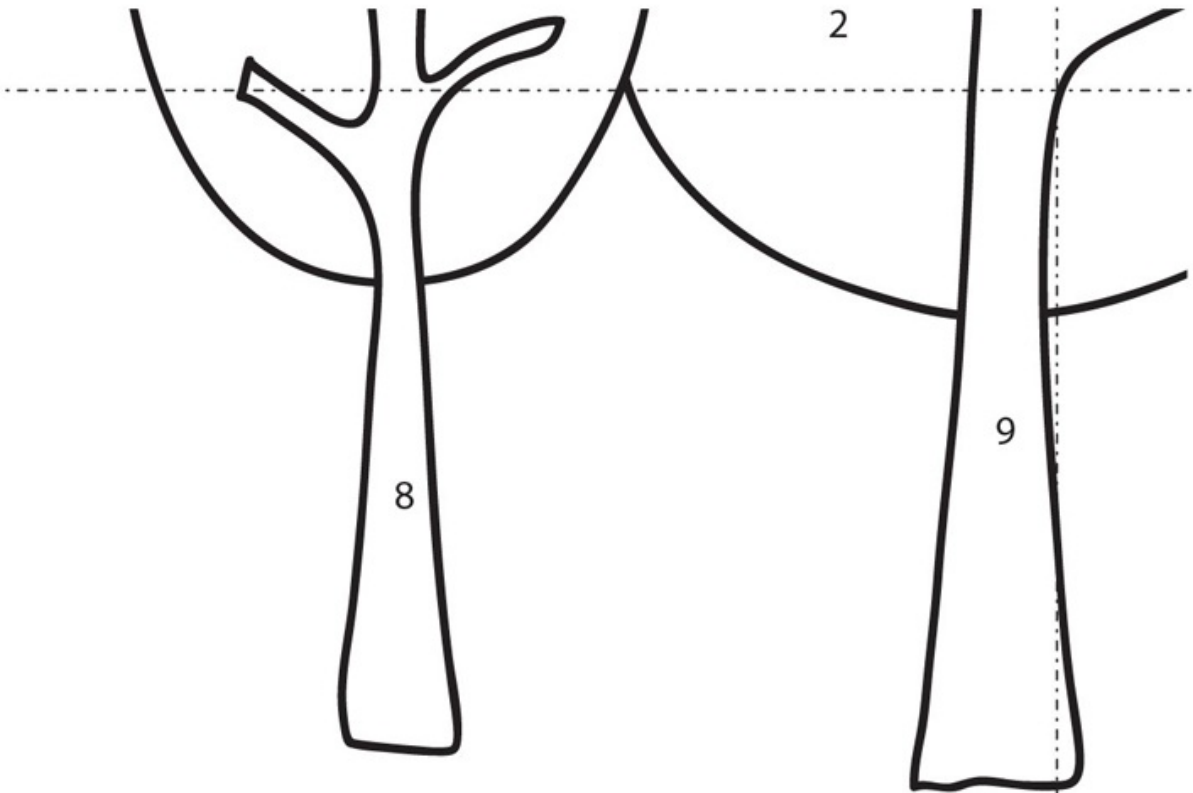
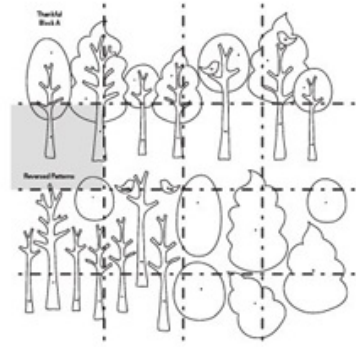
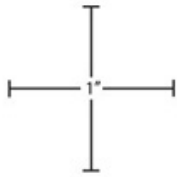

## Reversed Patterns

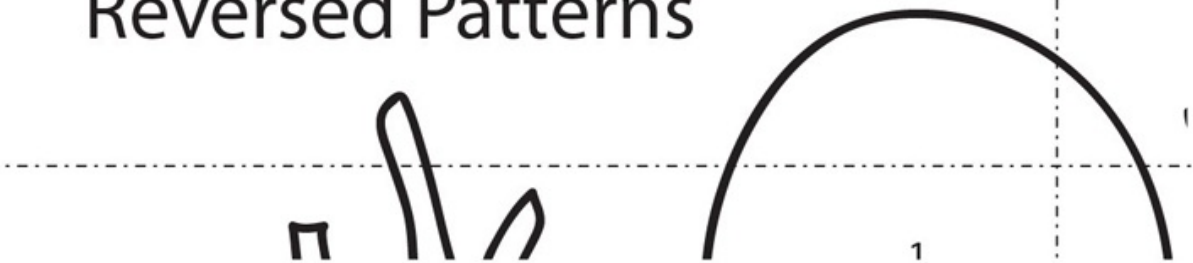

For all printable patterns or digital content: <http://tinyurl.com/11106-patterns-download>

# Thankful: block A

Note: Patterns are also printed in reverse for fusible appliqué.

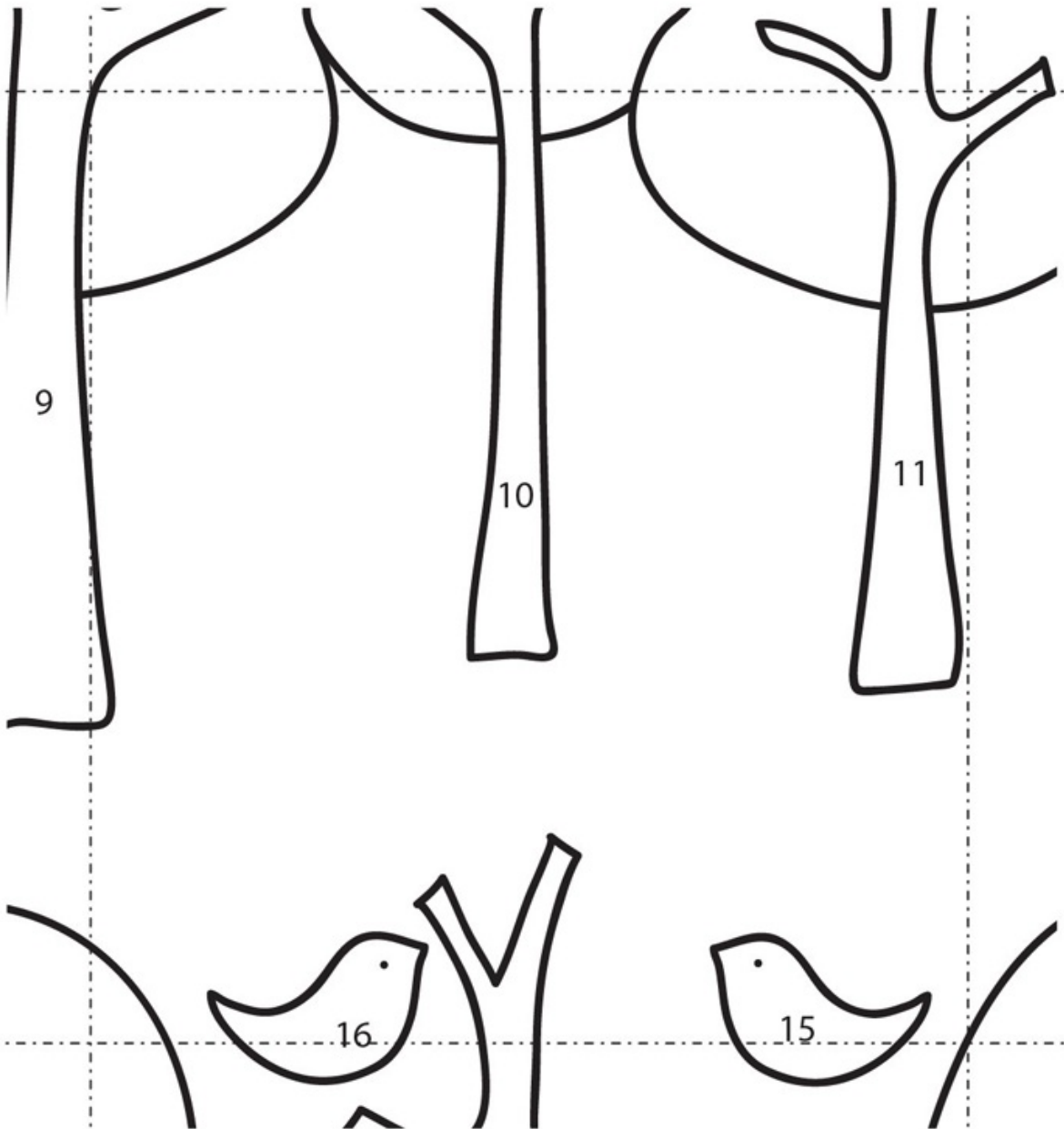
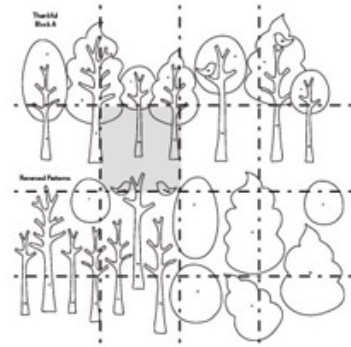
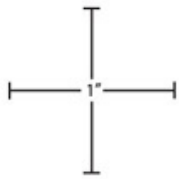



For all printable patterns or digital content: <http://tinyurl.com/11106-patterns-download>

# Thankful: block A

Note: Patterns are also printed in reverse for fusible appliqué.

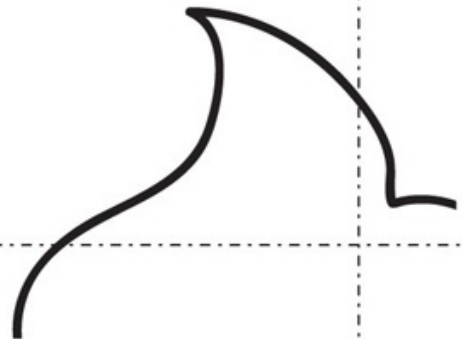
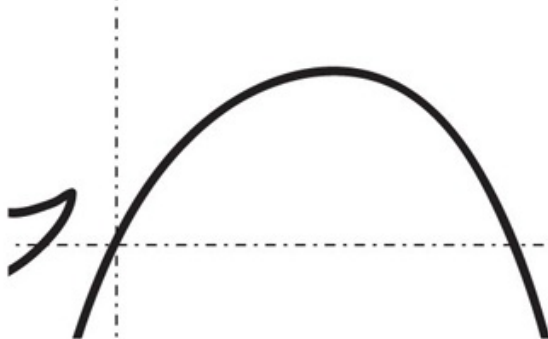
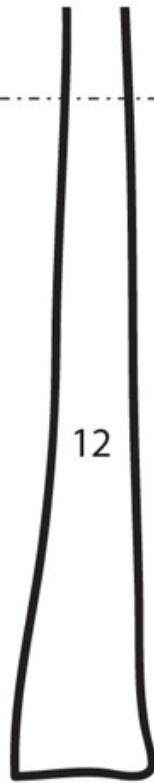
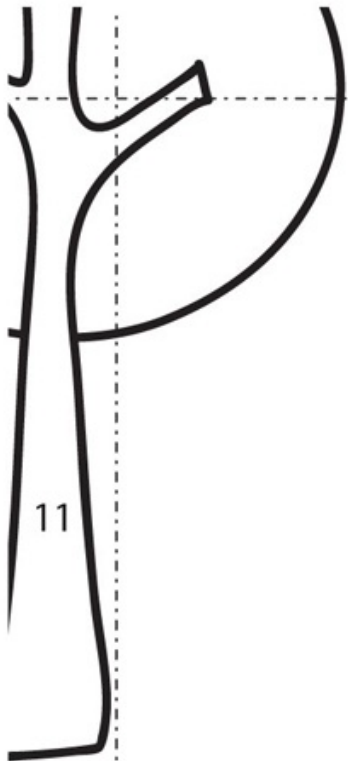
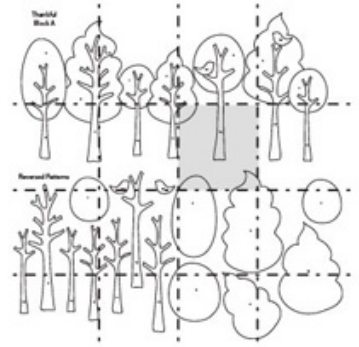
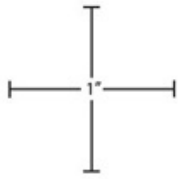

For all printable patterns or digital content: <http://tinyurl.com/11106-patterns-download>

**Thankful: block A**

*Note: Patterns are also printed in reverse for fusible appliqué.*

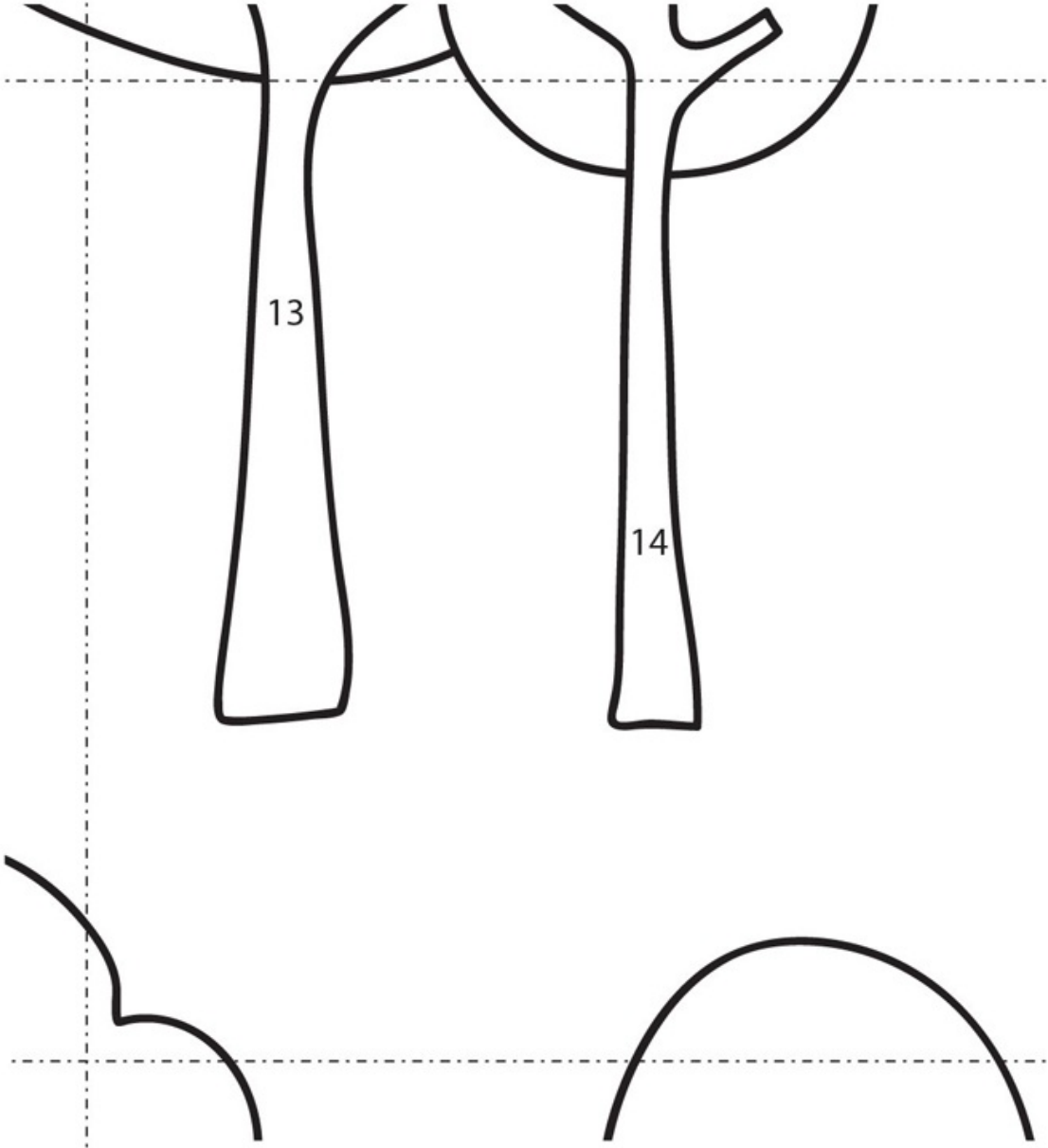
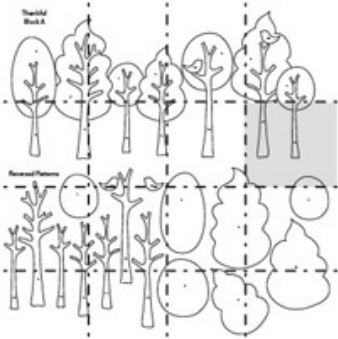
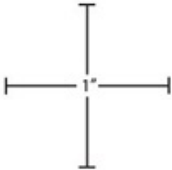

For all printable patterns or digital content: <http://tinyurl.com/11106-patterns-download>

# Thankful: block A

Note: Patterns are also printed in reverse for fusible appliqué.

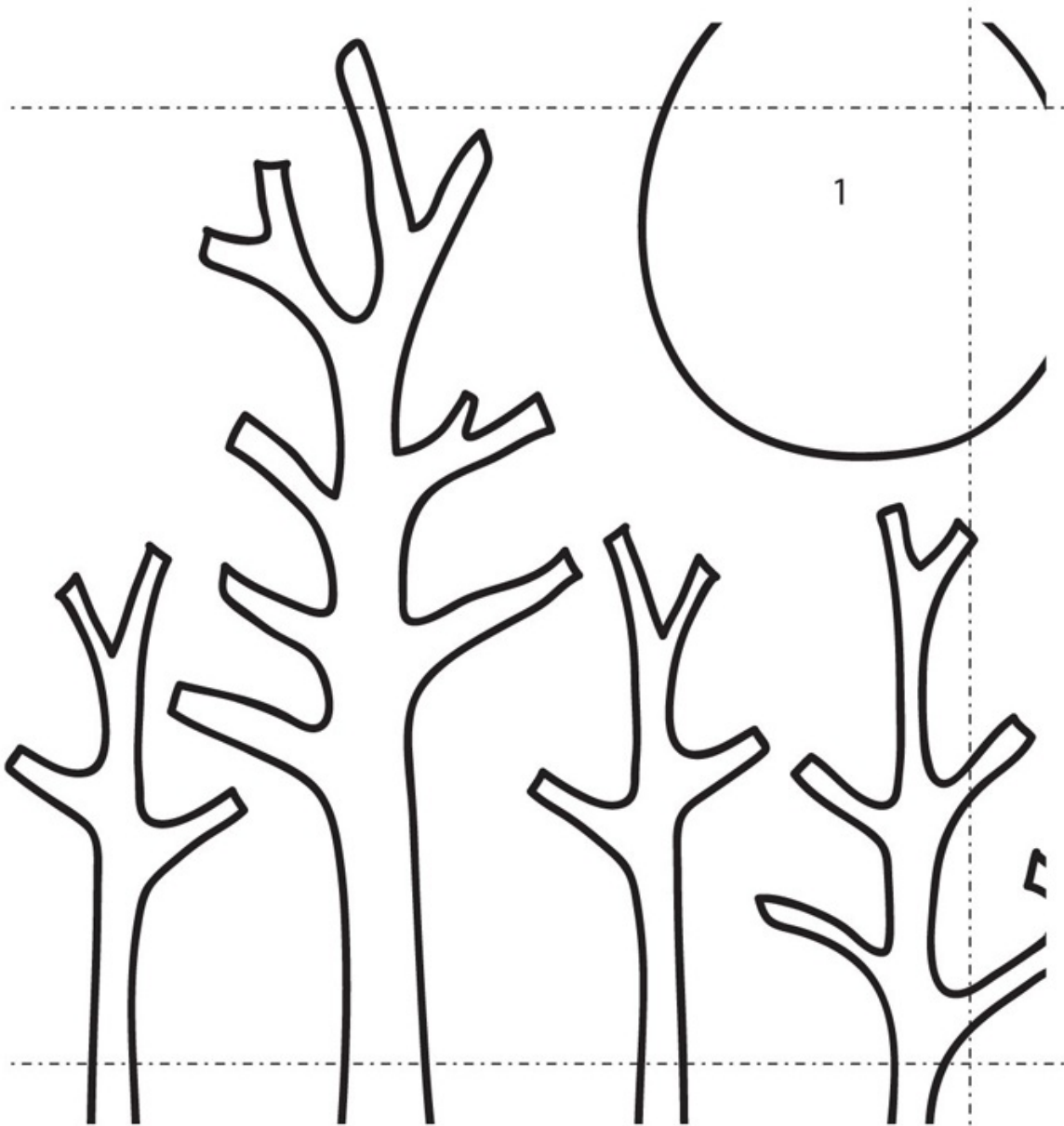
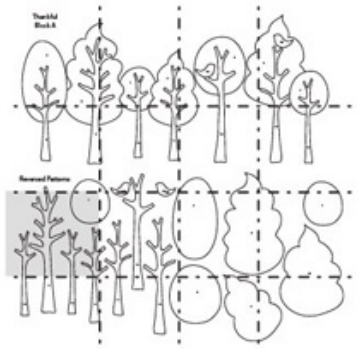
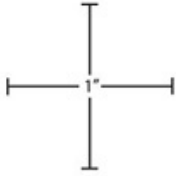

For all printable patterns or digital content: <http://tinyurl.com/11106-patterns-download>

## Thankful: block A

Note: Patterns are also printed in reverse for fusible appliqué.

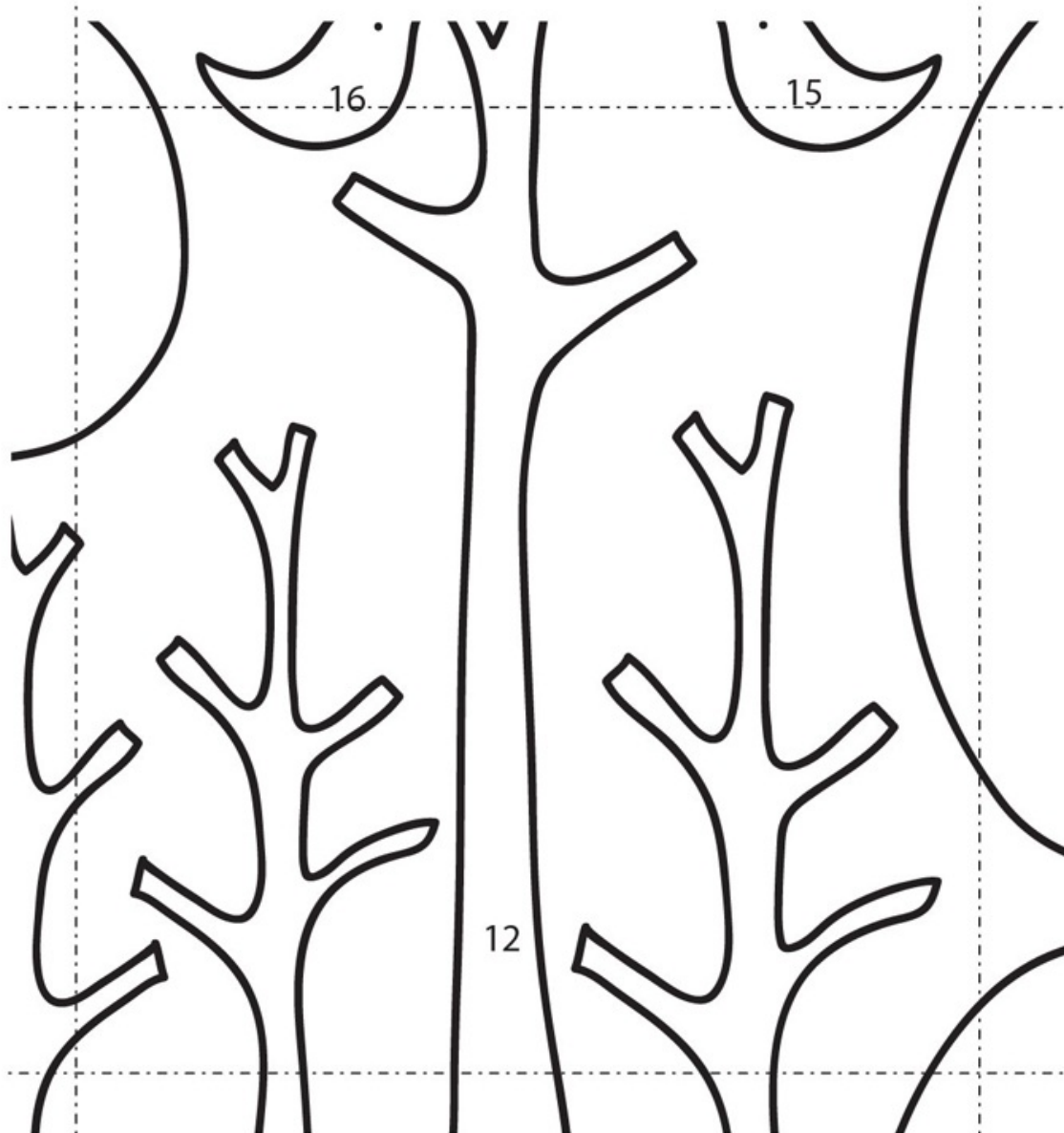
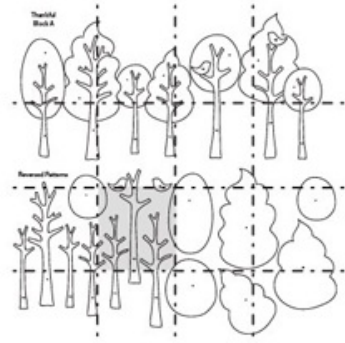
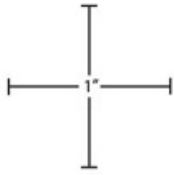

For all printable patterns or digital content: <http://tinyurl.com/11106->



patterns-download

# Thankful: block A

Note: Patterns are also printed in reverse for fusible appliqué.

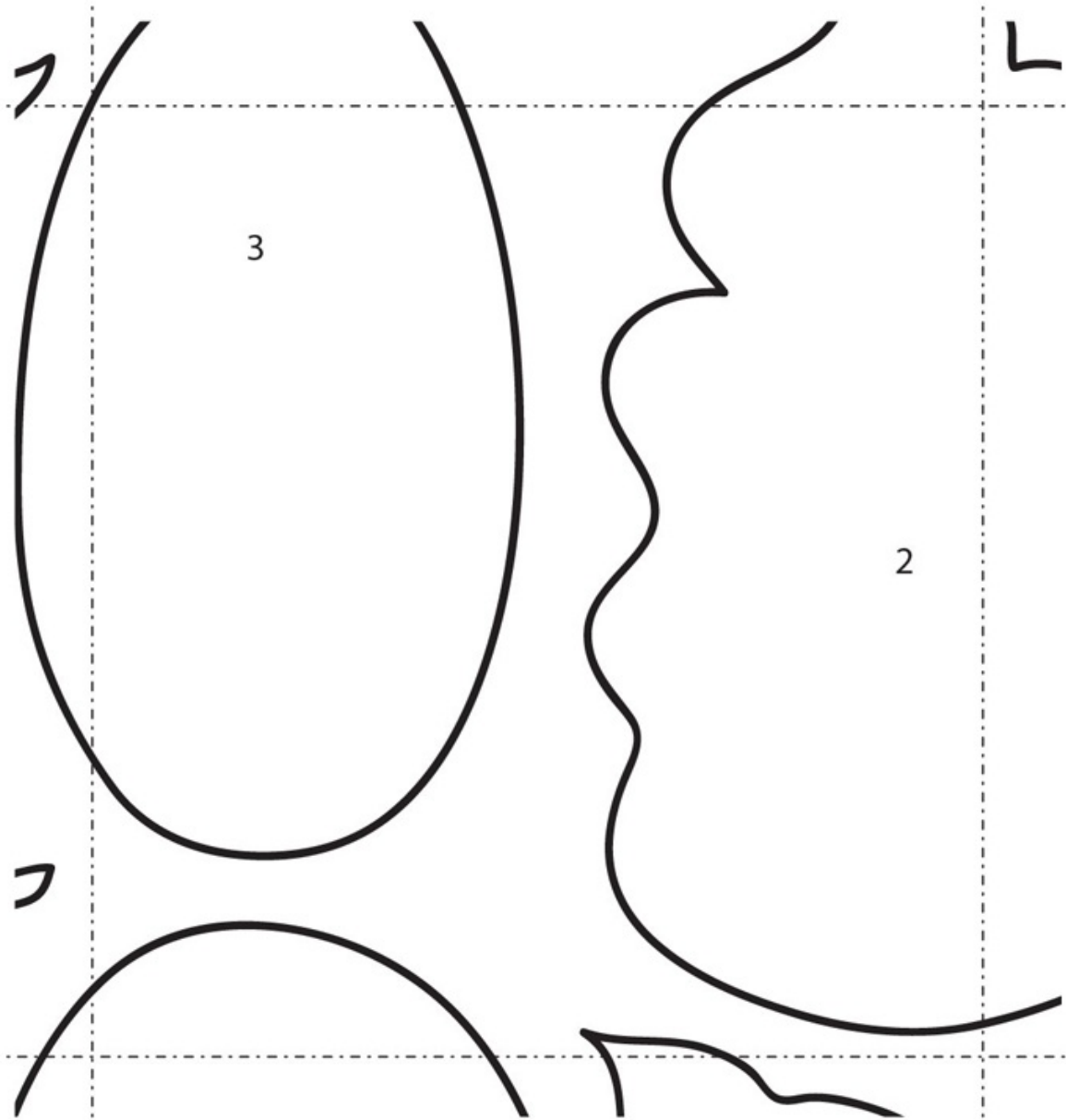
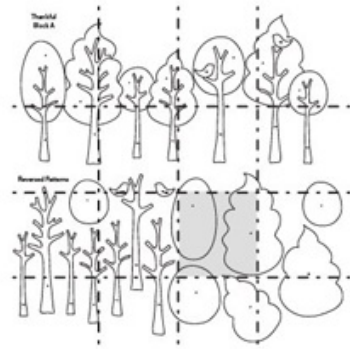
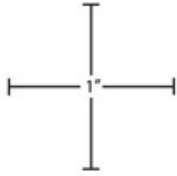

For all printable patterns or digital content: <http://tinyurl.com/11106-patterns-download>

# Thankful: block A

Note: Patterns are also printed in reverse for fusible appliqué.

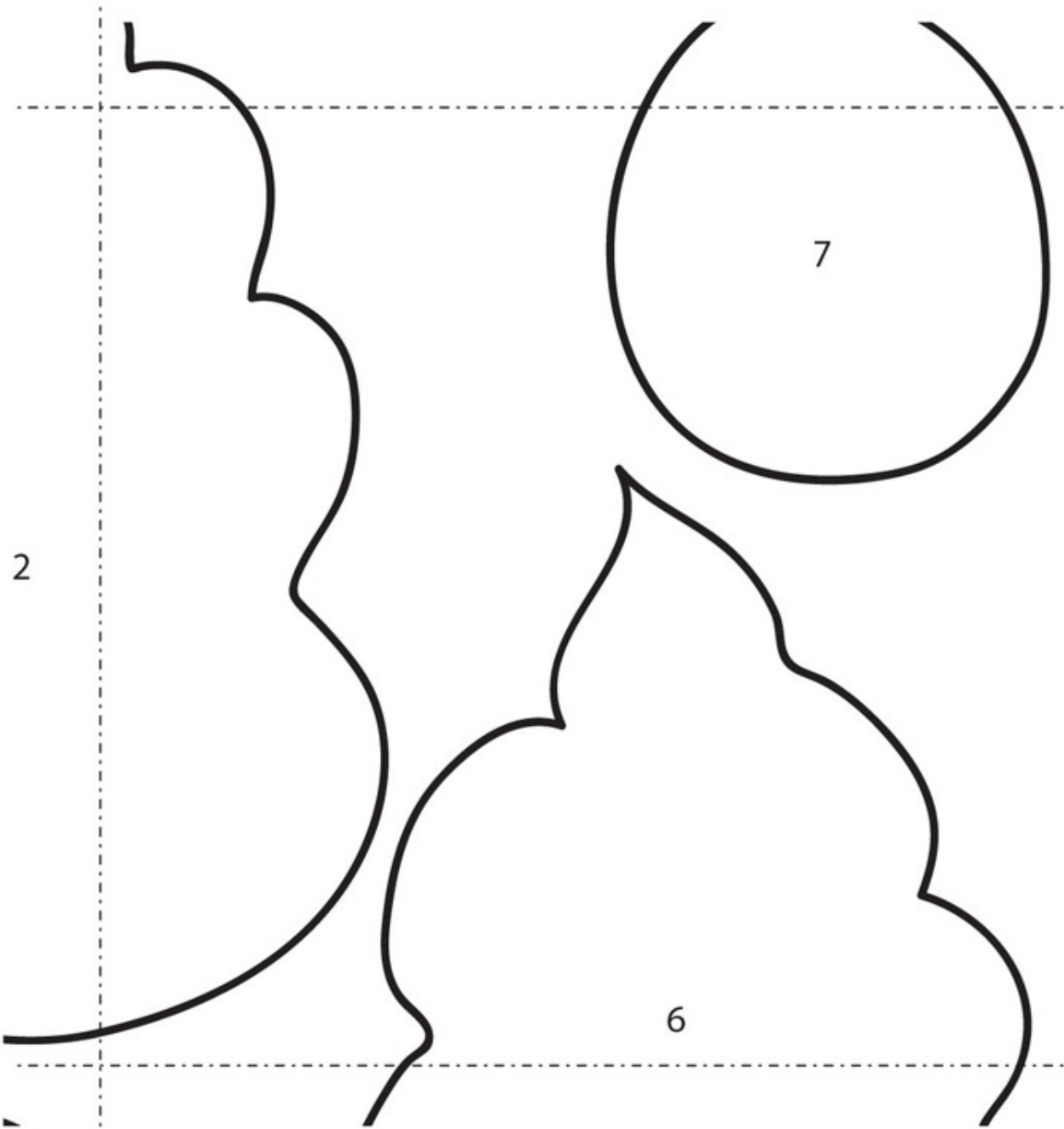
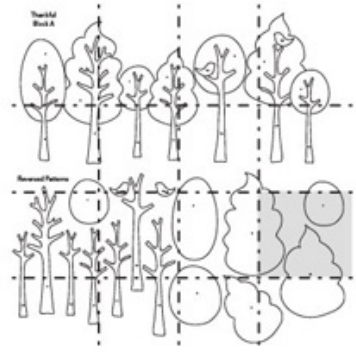
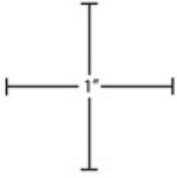

For all printable patterns or digital content: <http://tinyurl.com/11106-patterns-download>

# Thankful: block A

Note: Patterns are also printed in reverse for fusible appliqué.

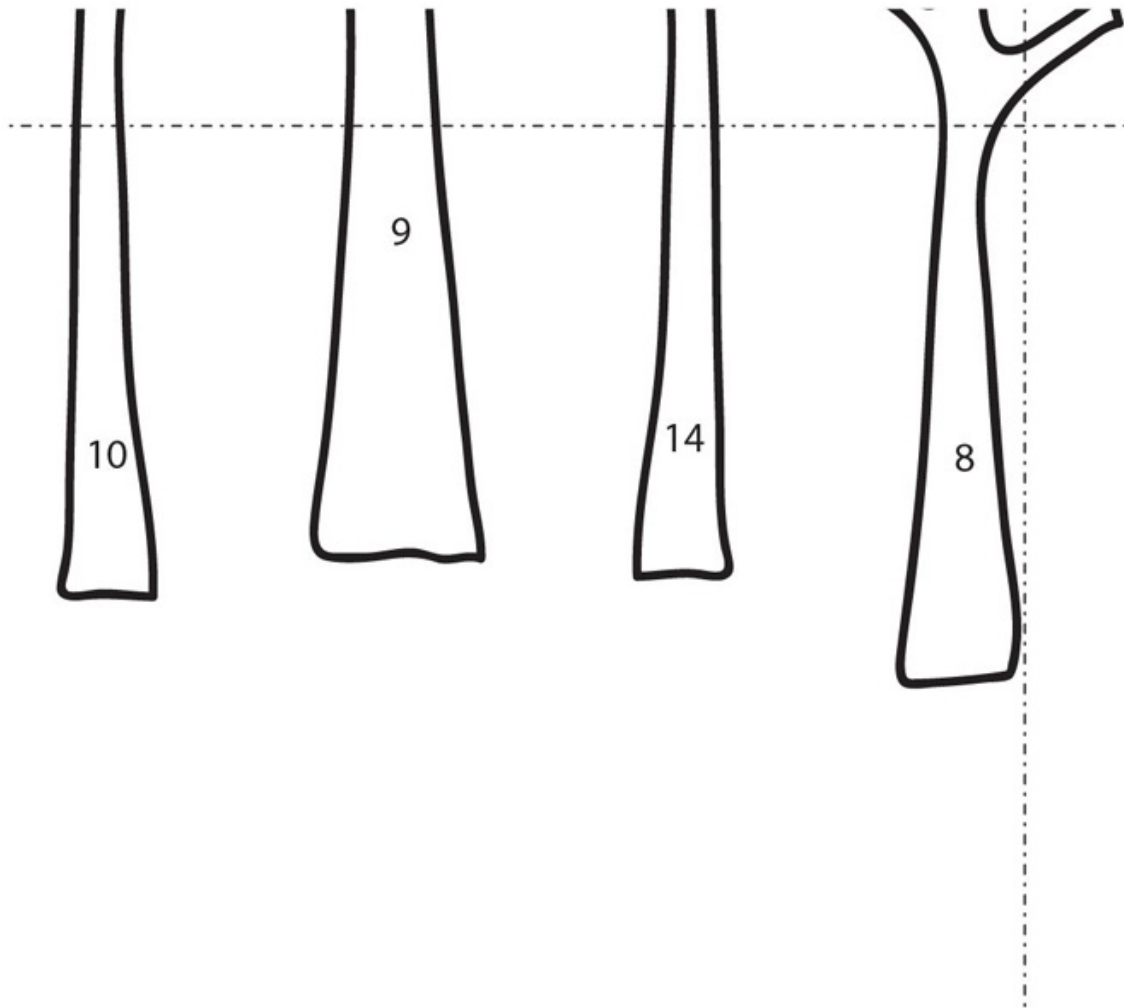
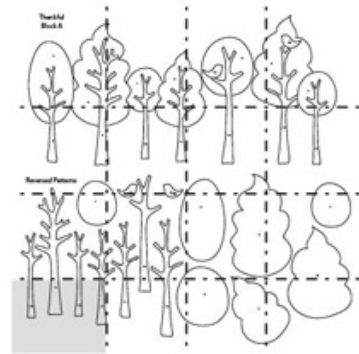
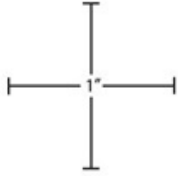

For all printable patterns or digital content: <http://tinyurl.com/11106-patterns-download>

# Thankful: block A

Note: Patterns are also printed in reverse for fusible appliqué.

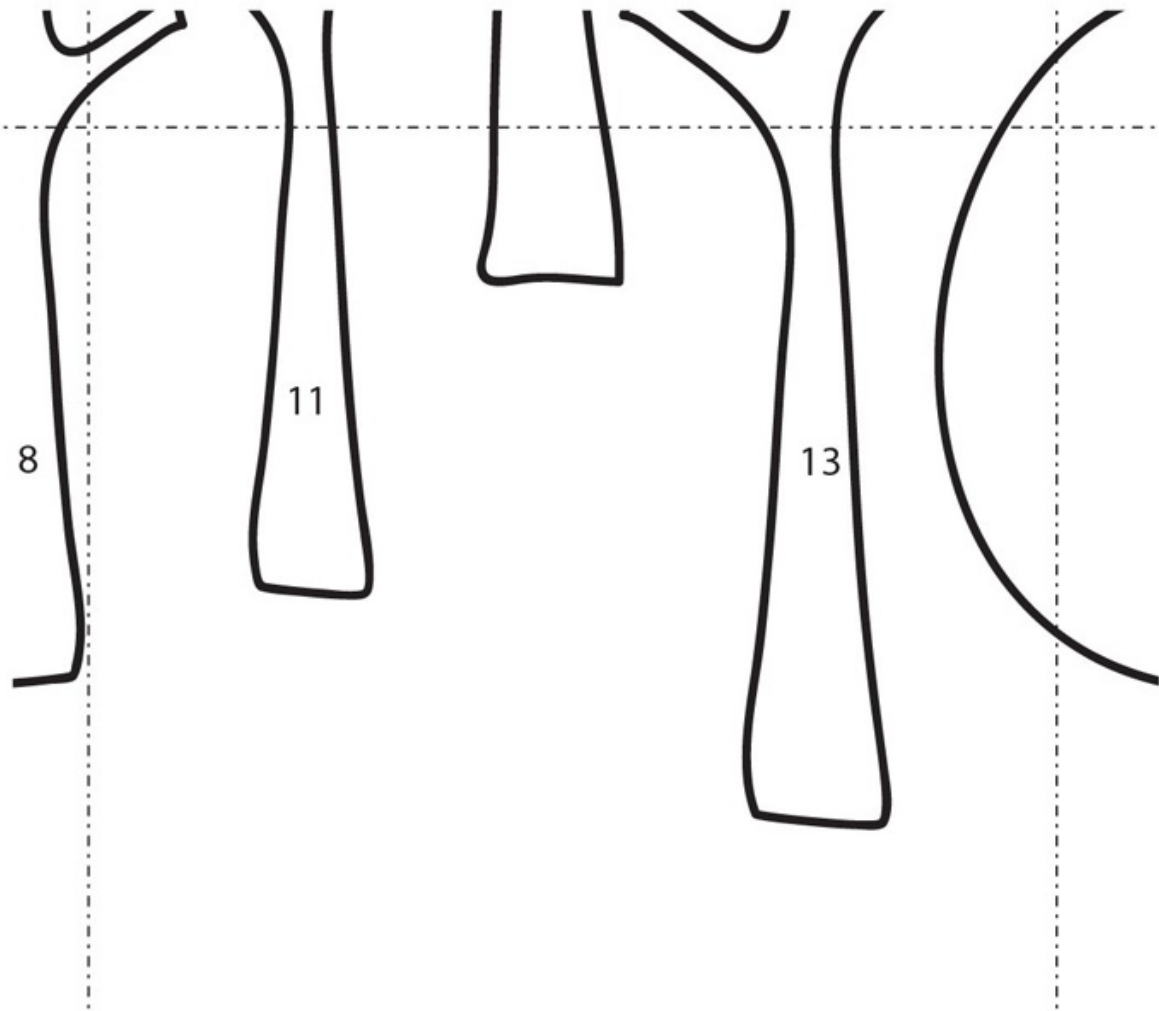
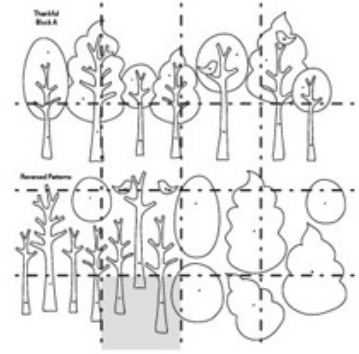
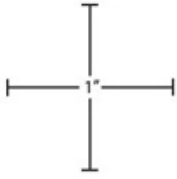



For all printable patterns or digital content: <http://tinyurl.com/11106-patterns-download>

## Thankful: block A

Note: Patterns are also printed in reverse for fusible appliqué.

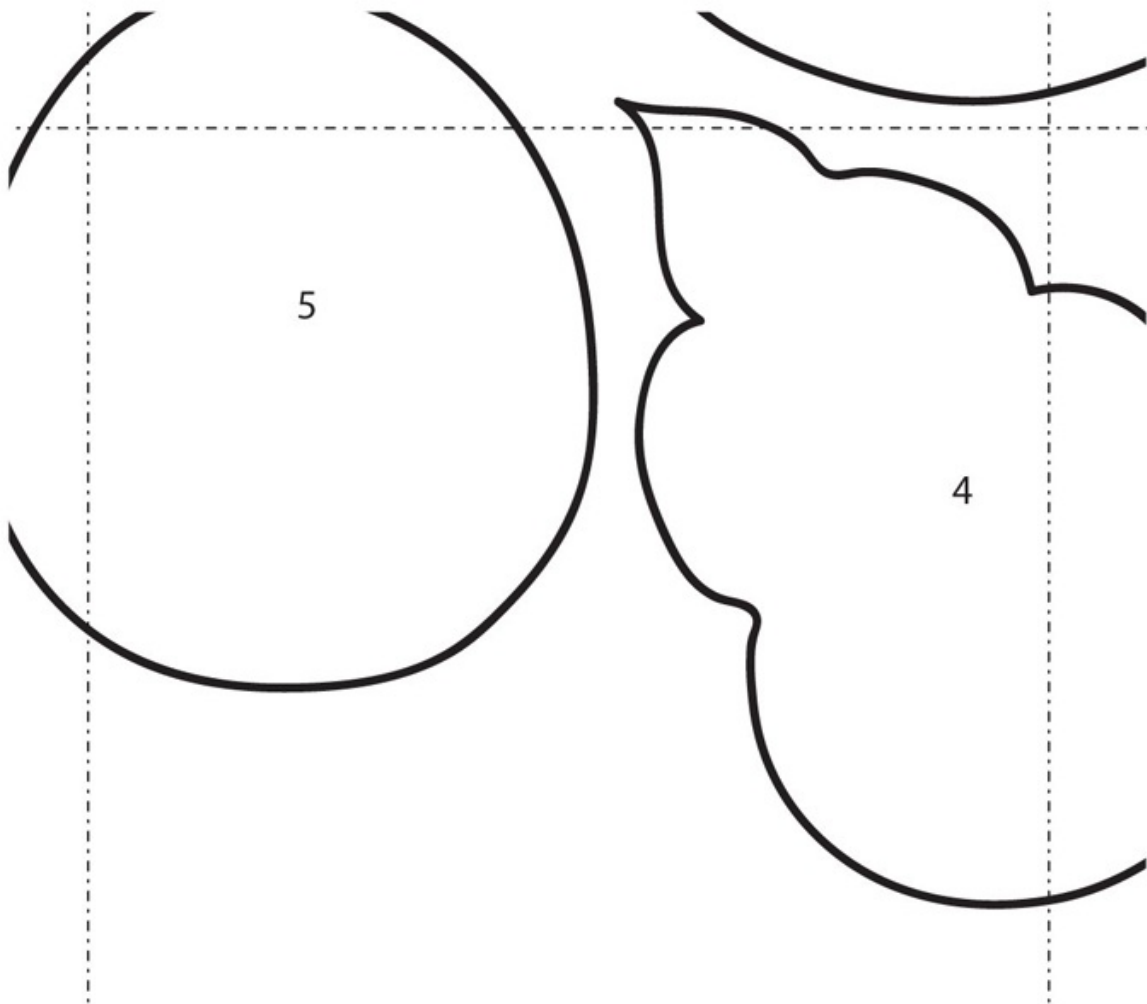
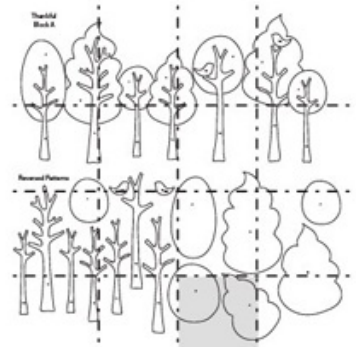
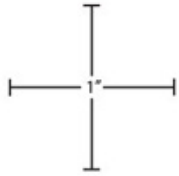

For all printable patterns or digital content: <http://tinyurl.com/11106-patterns-download>

# Thankful: block A

Note: Patterns are also printed in reverse for fusible appliqué.

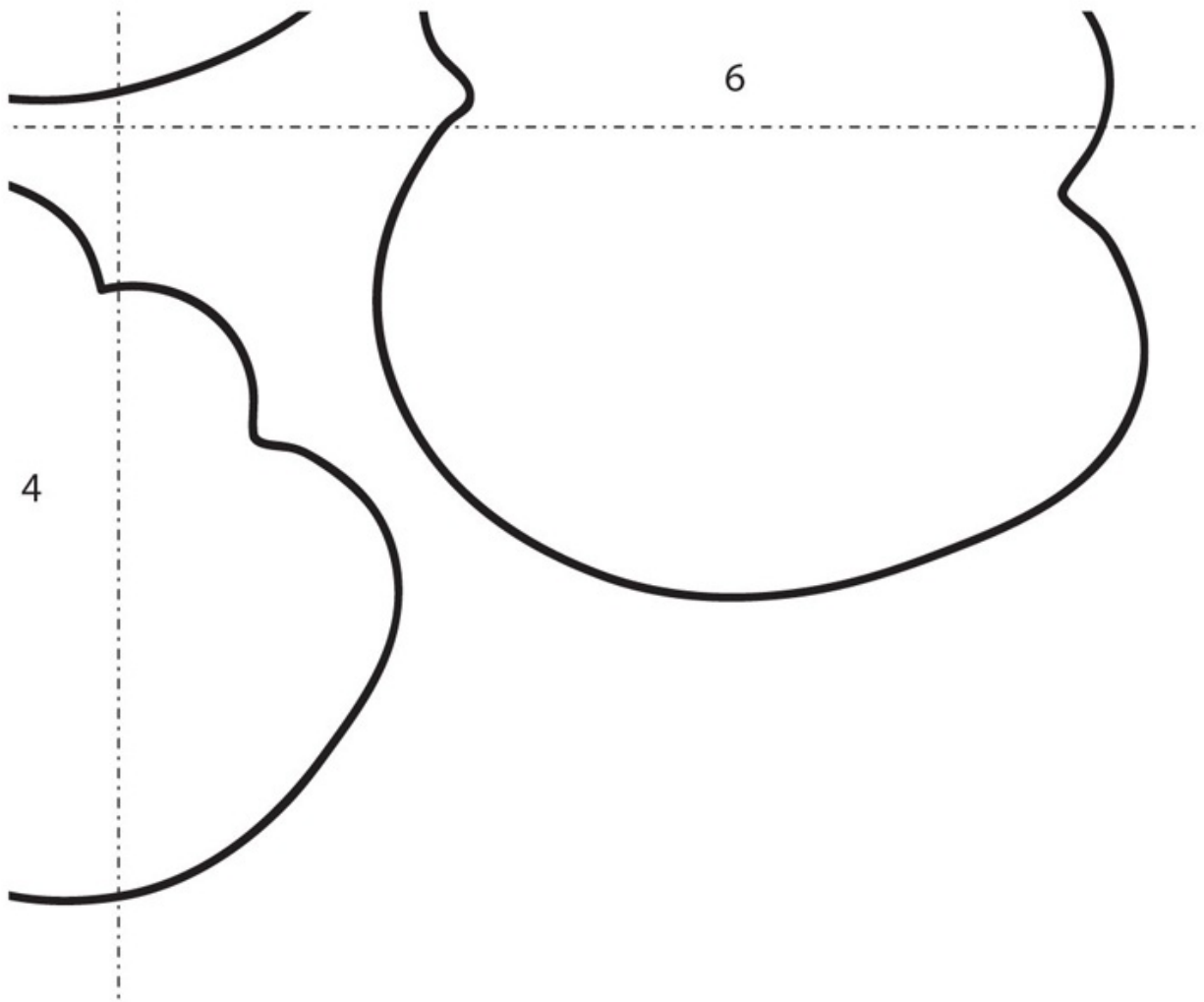
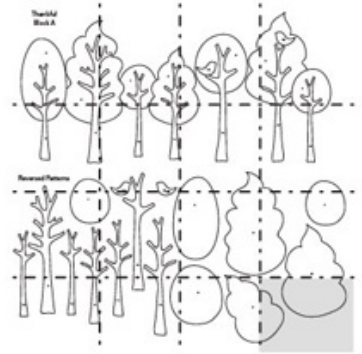
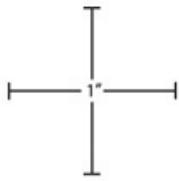

For all printable patterns or digital content: <http://tinyurl.com/11106-patterns-download>

### Thankful: block B

*Note: Patterns are also printed in reverse for fusible appliqué.*

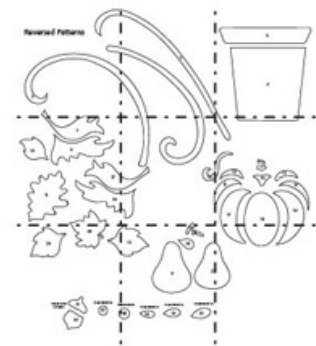
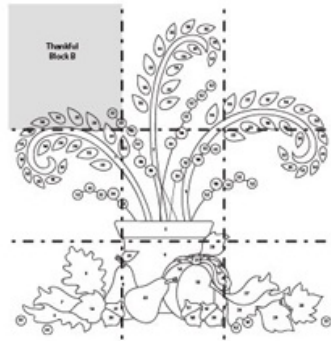
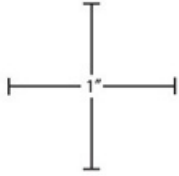

To make complete pattern, join the following pages, following the diagram for reference.

# Thankful Block B

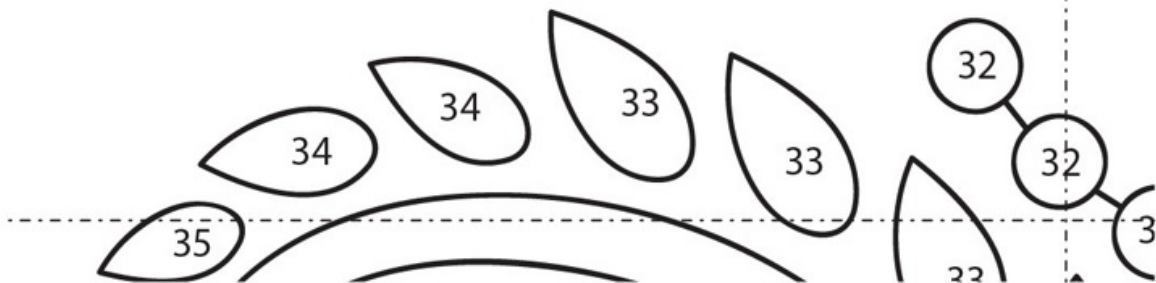

For all printable patterns or digital content: <http://tinyurl.com/11106-patterns-download>

## Thankful: block B

Note: Patterns are also printed in reverse for fusible appliqué.

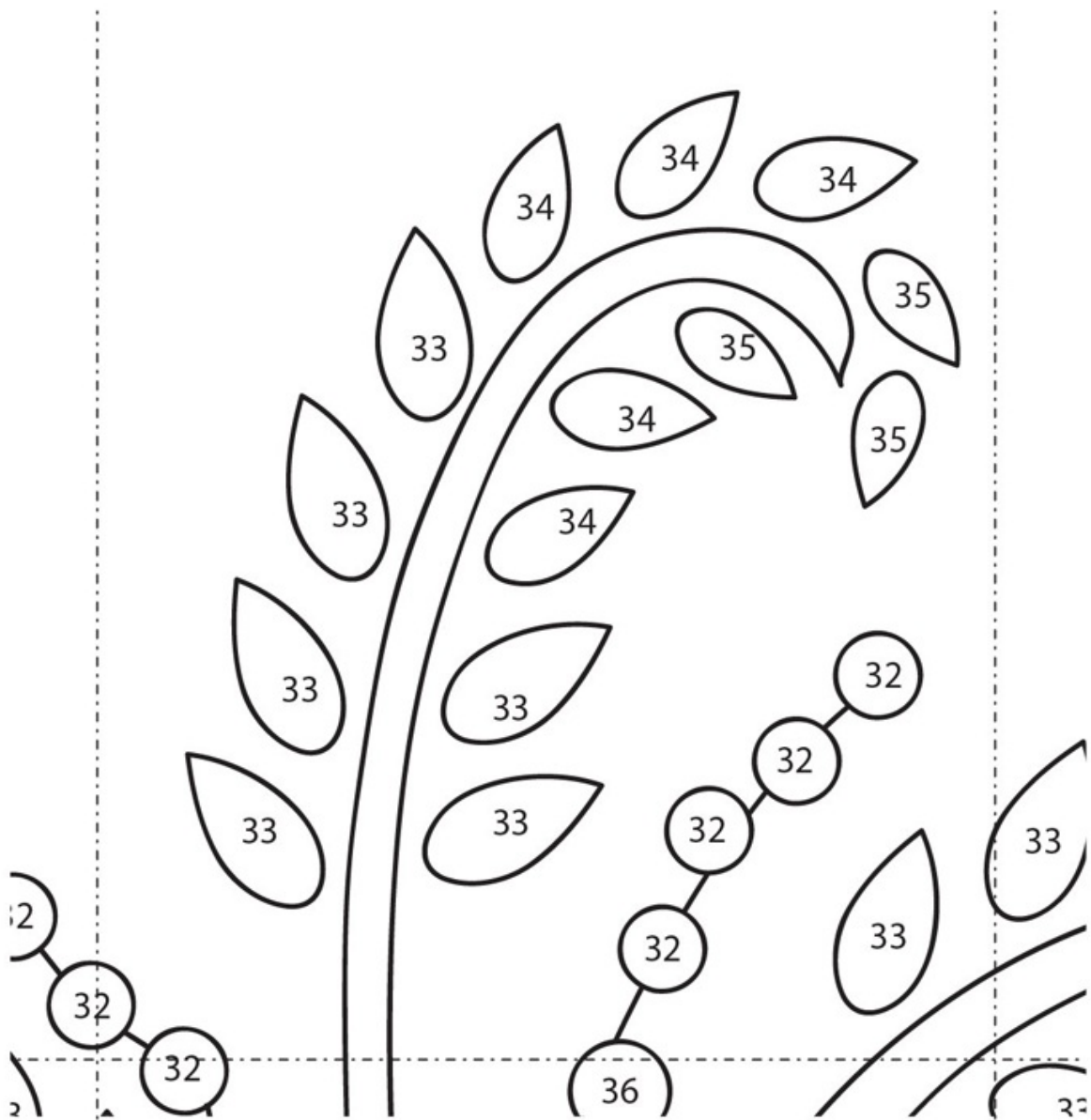
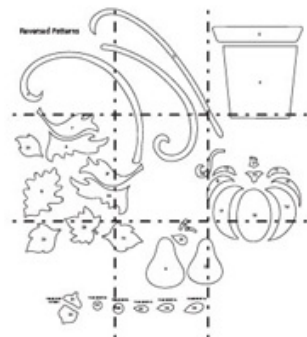
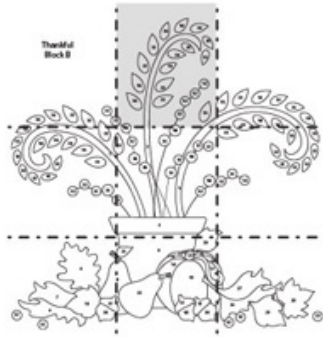
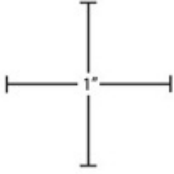

For all printable patterns or digital content: <http://tinyurl.com/11106-patterns-download>



# Thankful: block B

Note: Patterns are also printed in reverse for fusible appliqué.

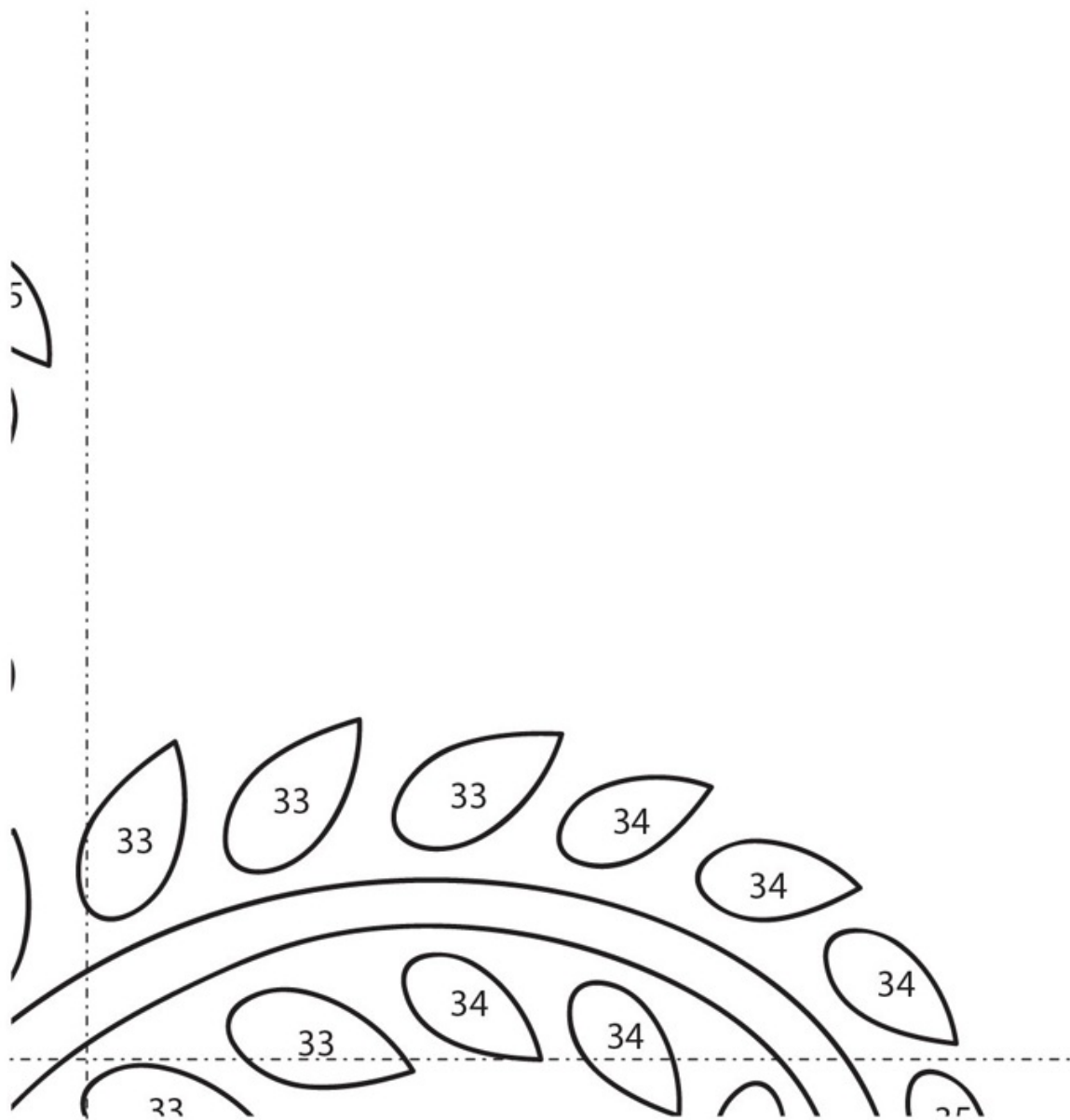
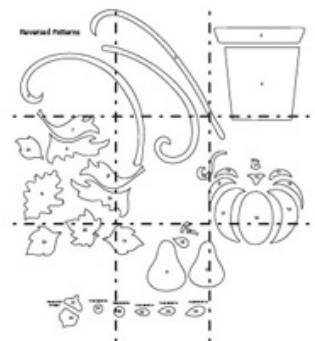
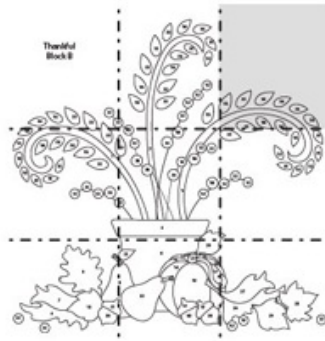
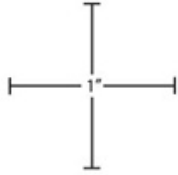

For all printable patterns or digital content: <http://tinyurl.com/11106-patterns-download>

# Thankful: block B

Note: Patterns are also printed in reverse for fusible appliqué.

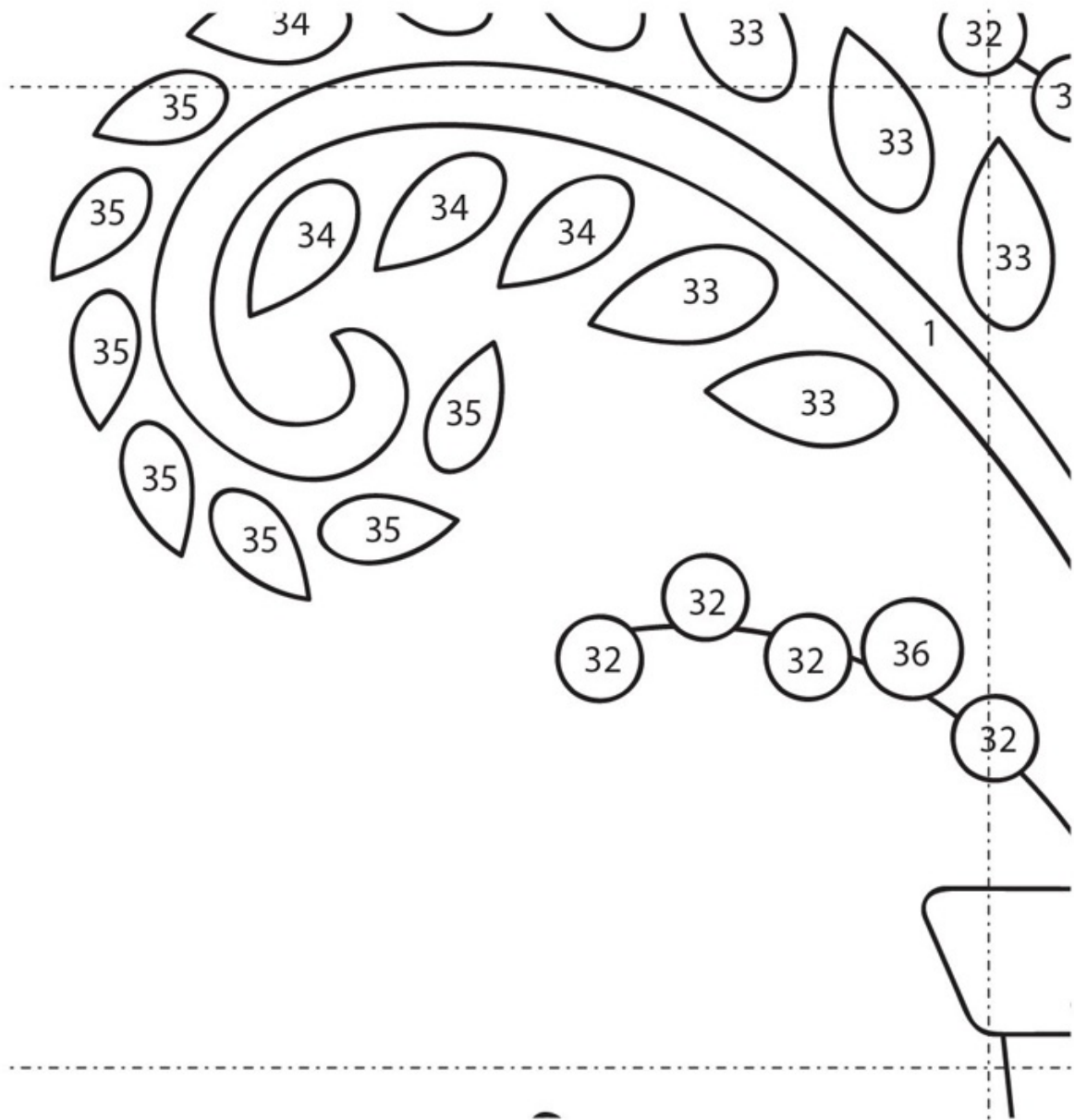
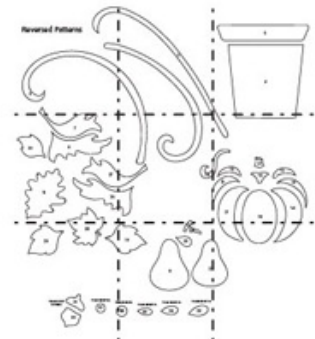
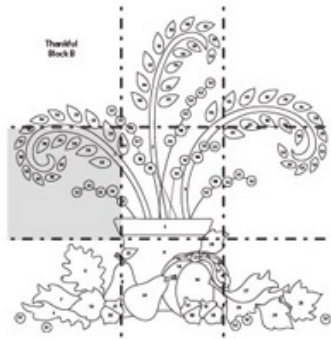
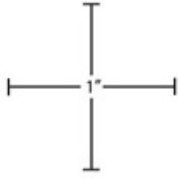

For all printable patterns or digital content: <http://tinyurl.com/11106-patterns-download>

**Thankful: block B**

Note: Patterns are also printed in reverse for fusible appliqué.

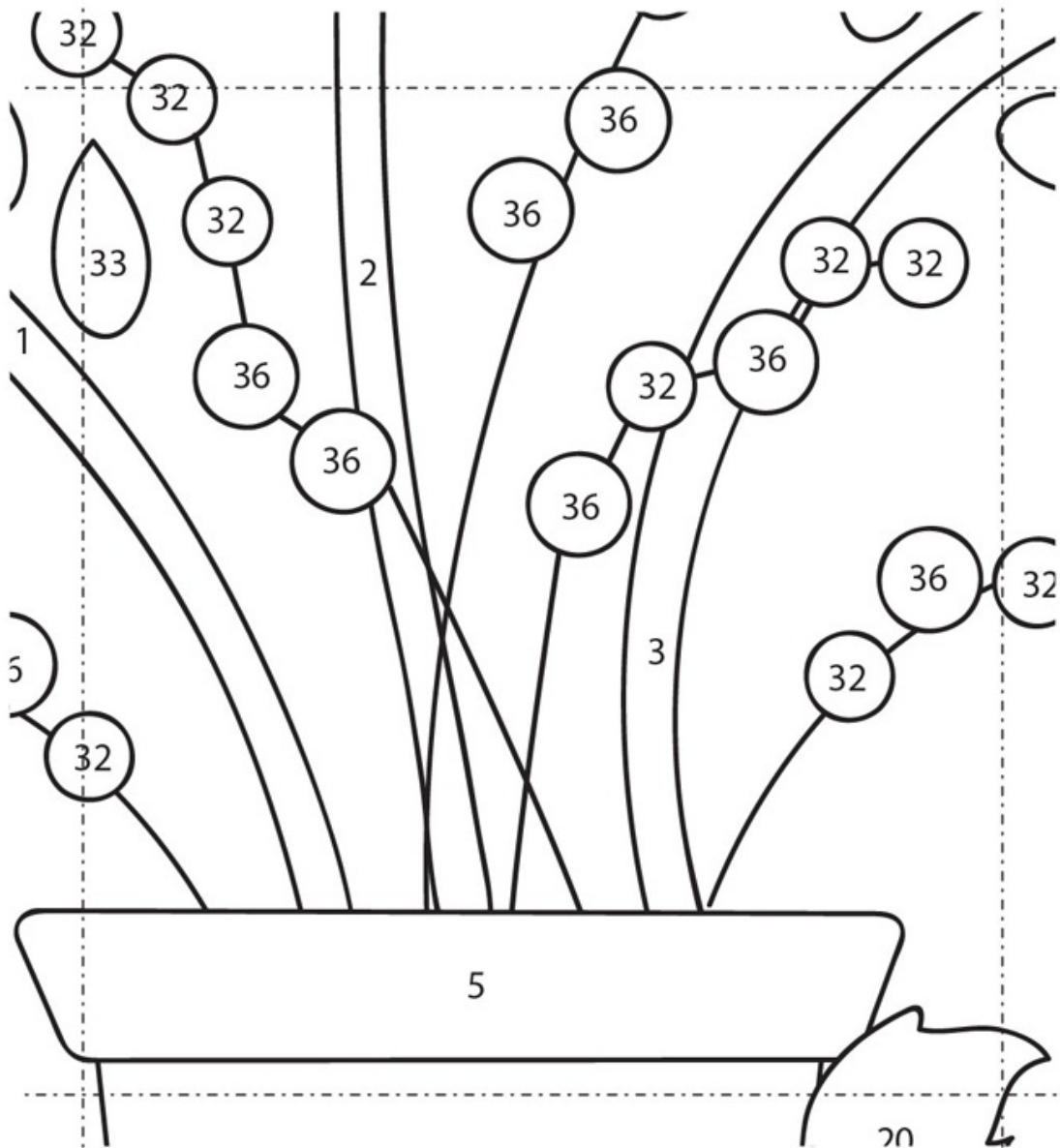
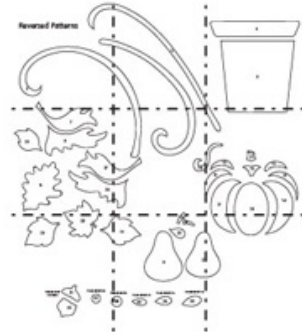
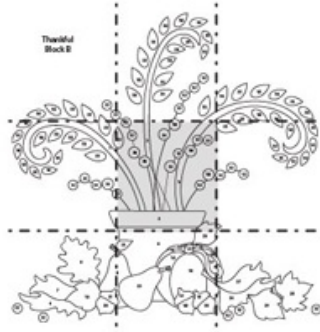
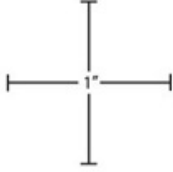

For all printable patterns or digital content: <http://tinyurl.com/11106->

### Thankful: block B

Note: Patterns are also printed in reverse for fusible appliqué.

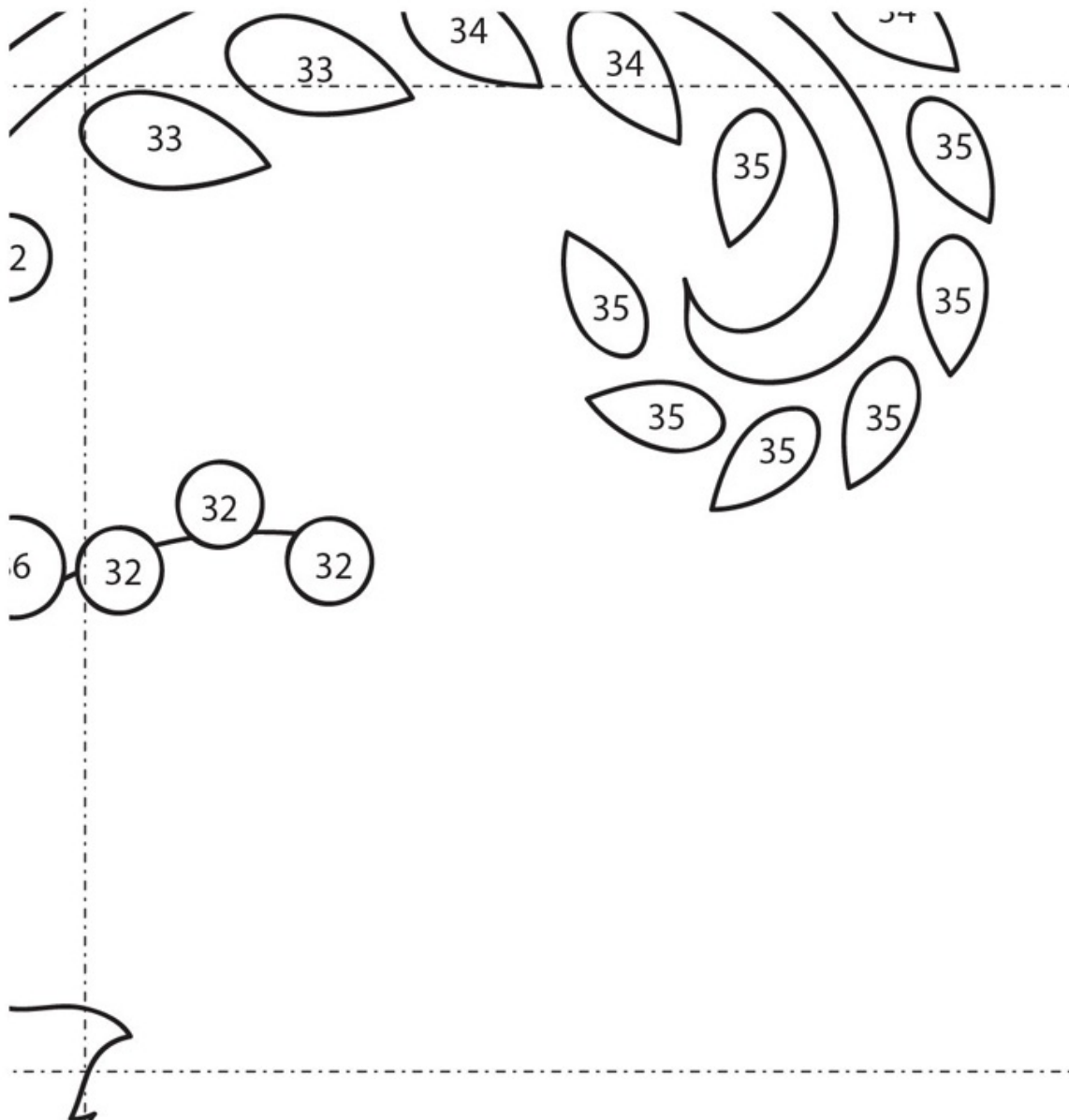
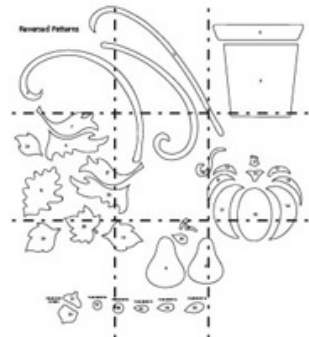
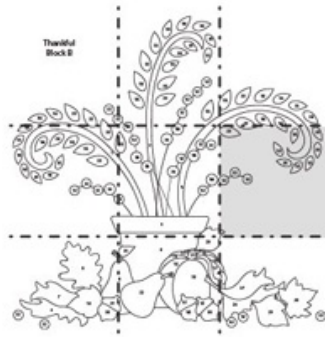
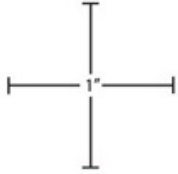

For all printable patterns or digital content: <http://tinyurl.com/11106-patterns-download>

## Thankful: block B

Note: Patterns are also printed in reverse for fusible appliqué.

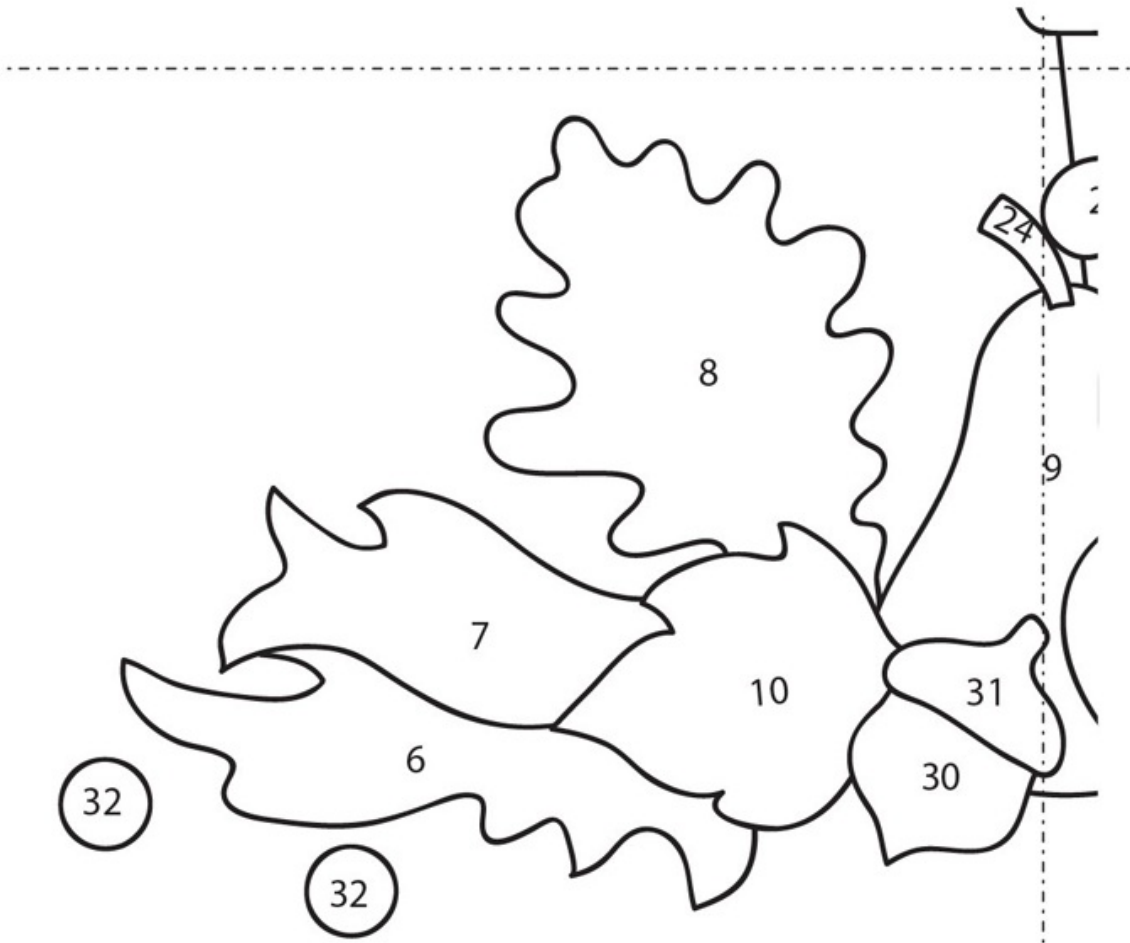
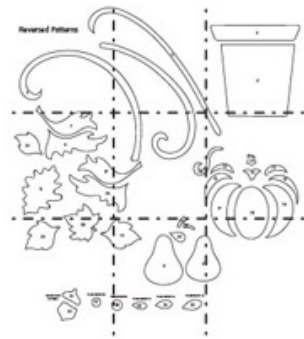
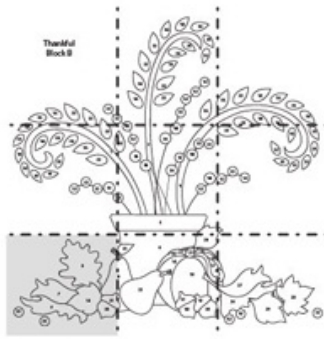
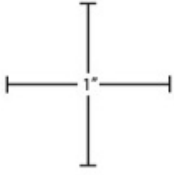



For all printable patterns or digital content: <http://tinyurl.com/11106-patterns-download>

**Thankful: block B**

*Note: Patterns are also printed in reverse for fusible appliqué.*

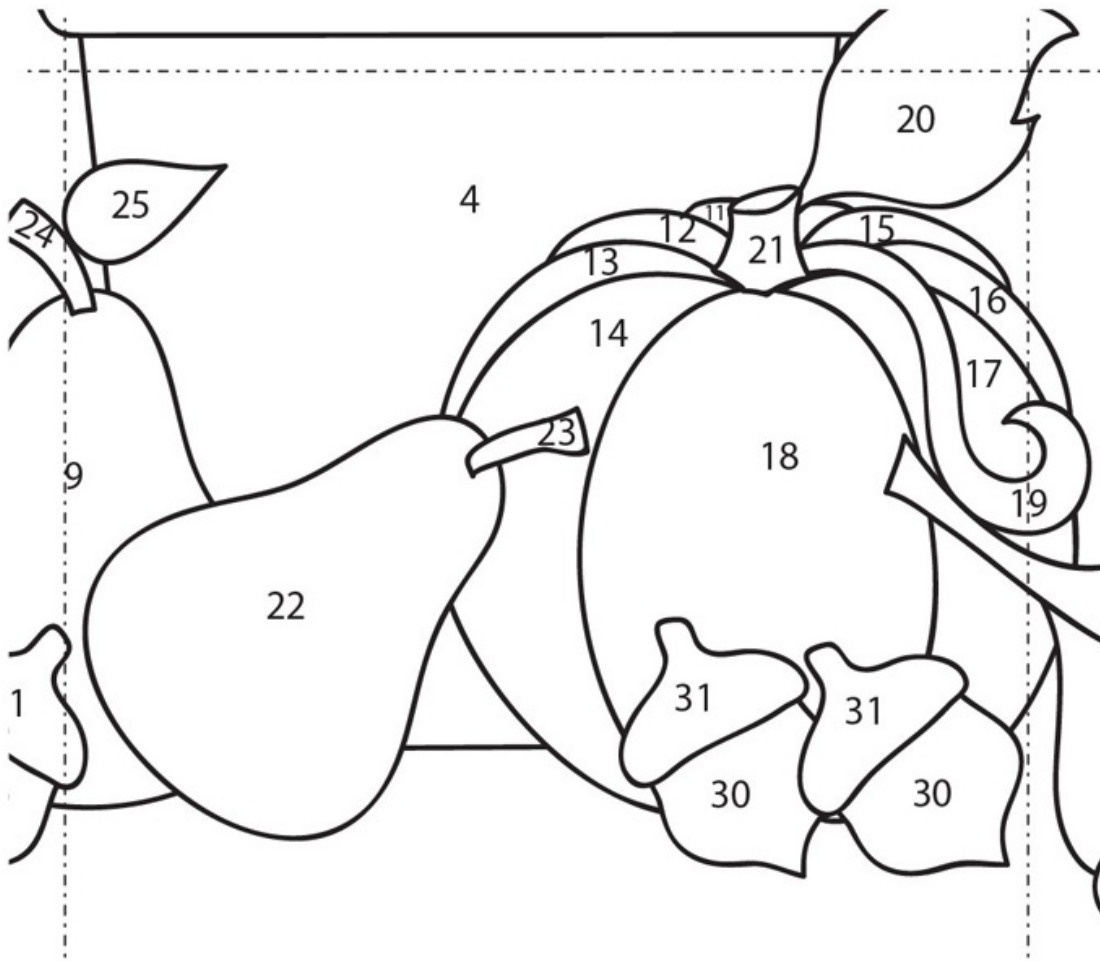
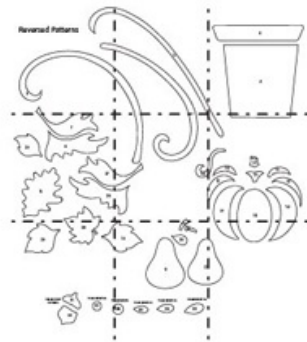
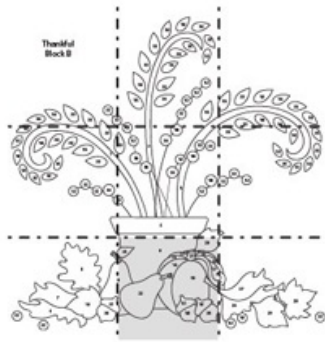
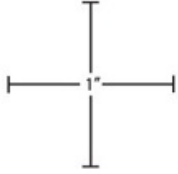

For all printable patterns or digital content: <http://tinyurl.com/11106-patterns-download>

## Thankful: block B

Note: Patterns are also printed in reverse for fusible appliqué.

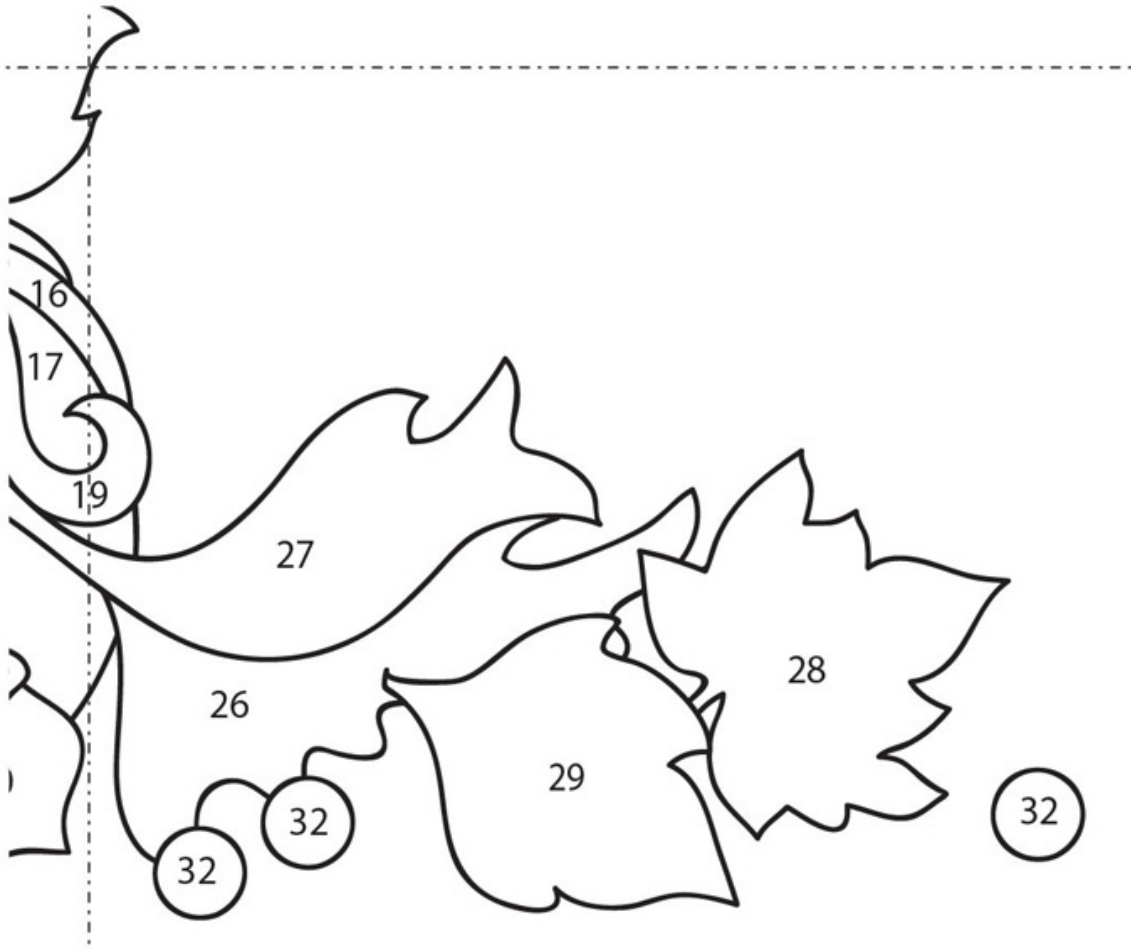
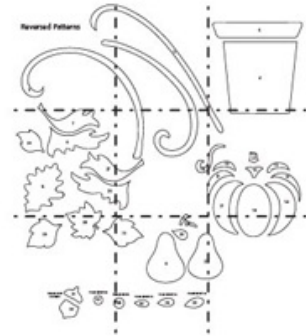
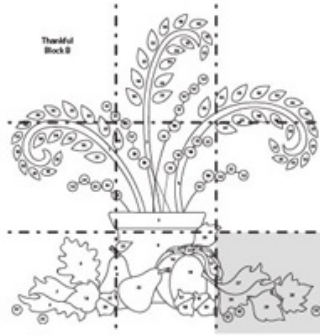
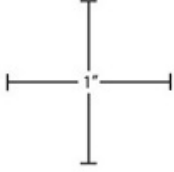

For all printable patterns or digital content: <http://tinyurl.com/11106->

patterns-download

## Thankful: block B

Note: Patterns are also printed in reverse for fusible appliqué.

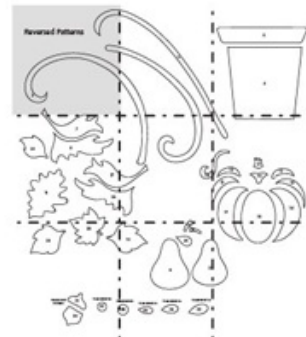
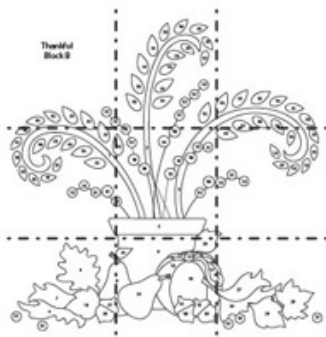
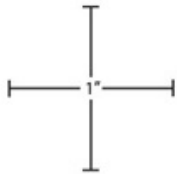

## Reversed Patterns

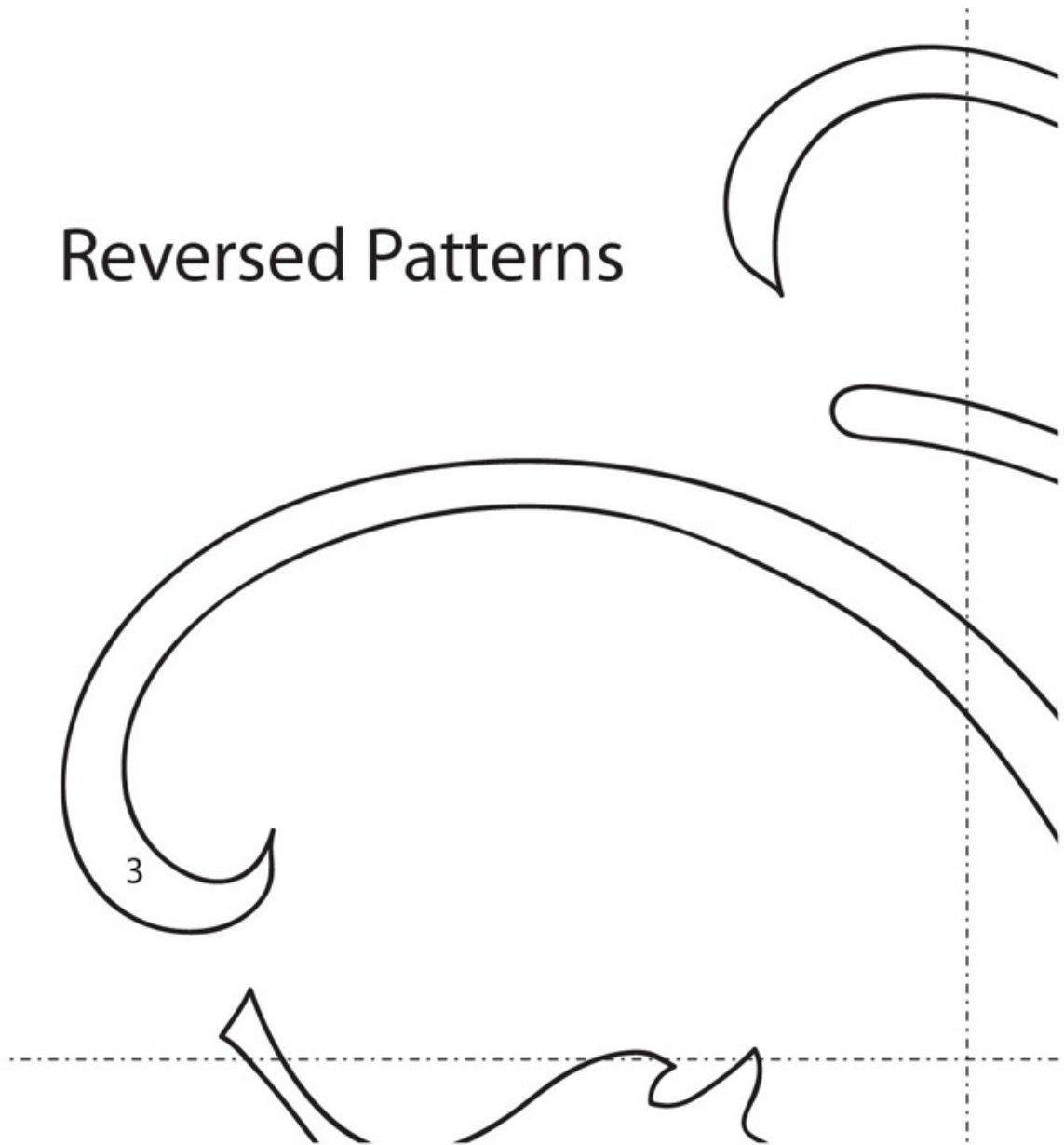

For all printable patterns or digital content: <http://tinyurl.com/11106-patterns-download>

# Thankful: block B

Note: Patterns are also printed in reverse for fusible appliqué.

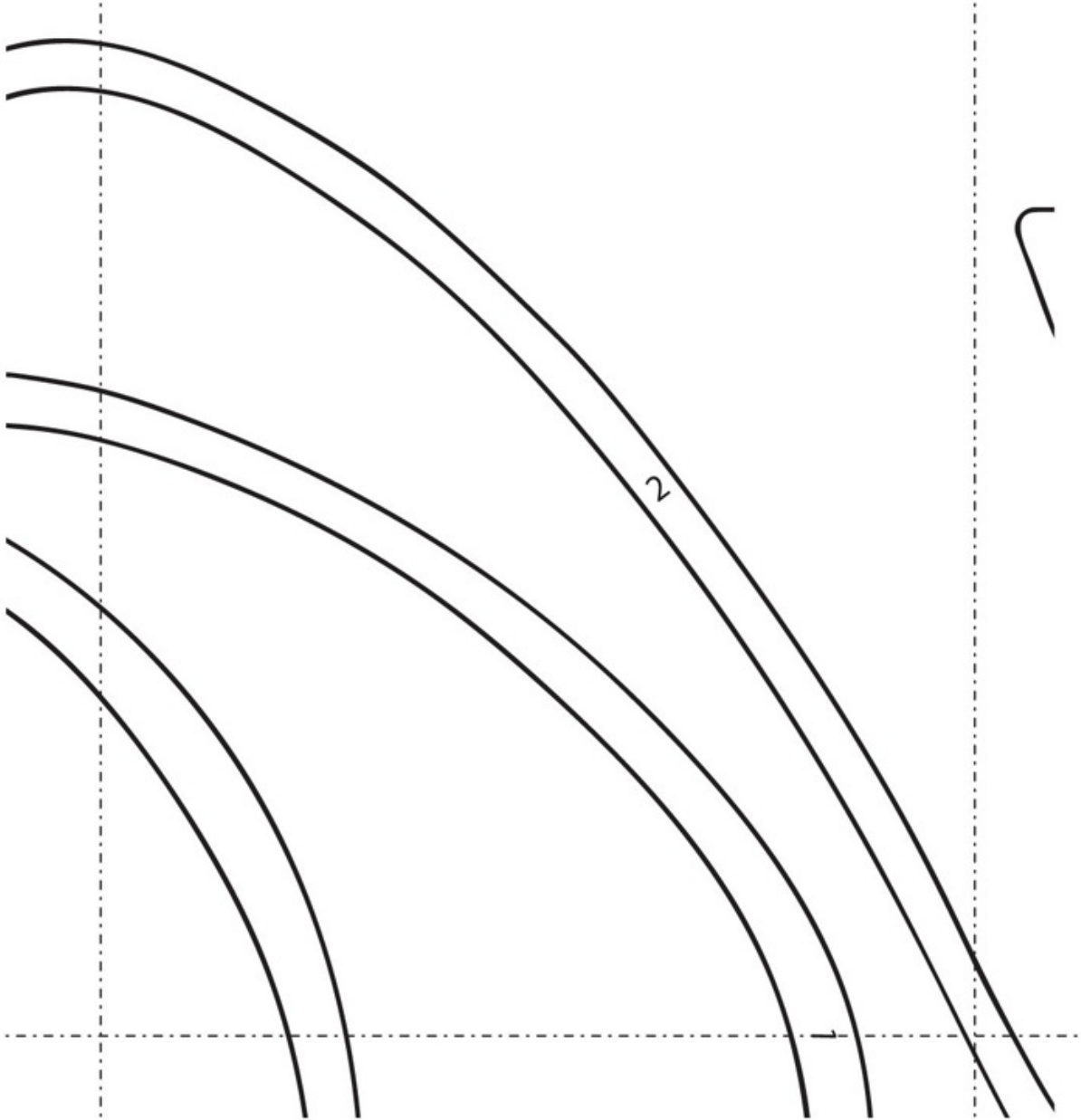
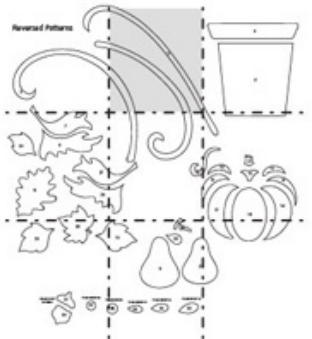
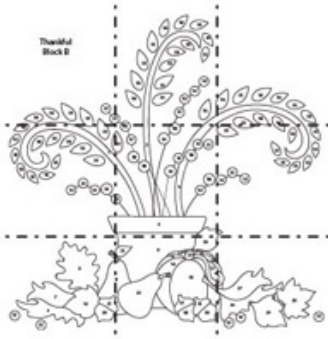
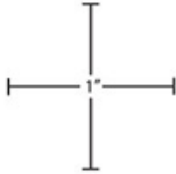

For all printable patterns or digital content: <http://tinyurl.com/11106-patterns-download>



## Thankful: block B

Note: Patterns are also printed in reverse for fusible appliqué.

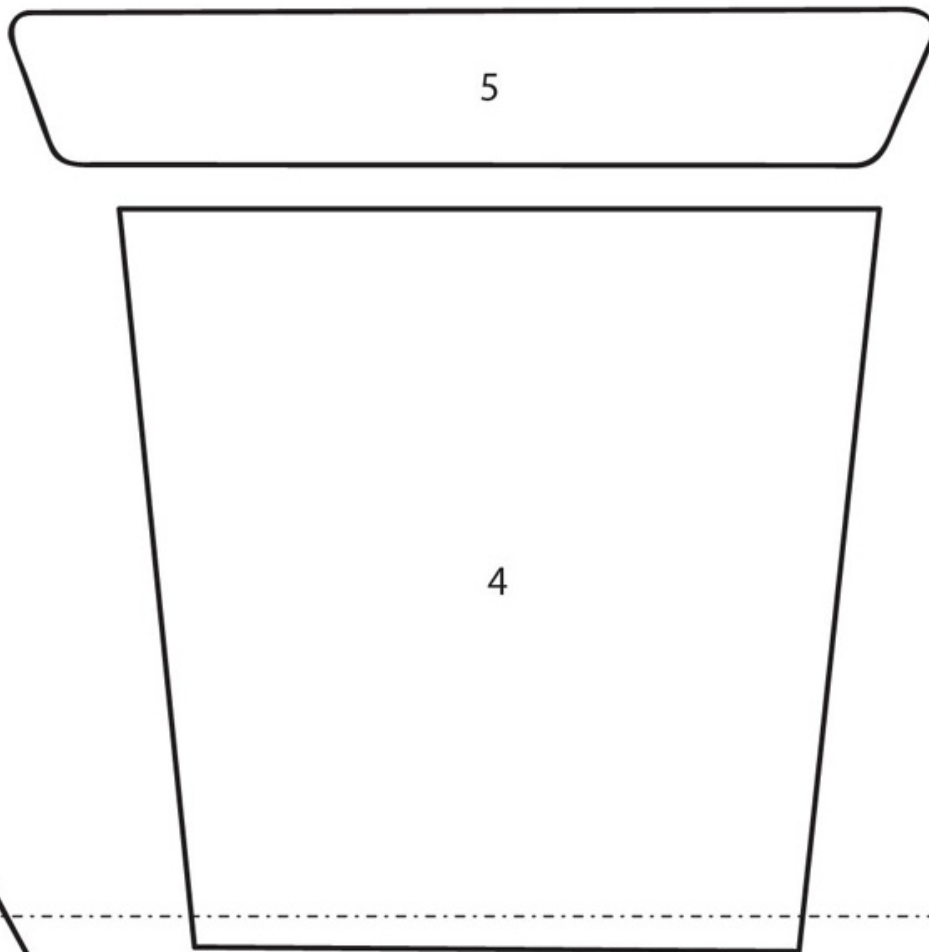
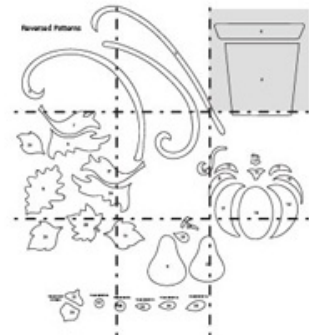
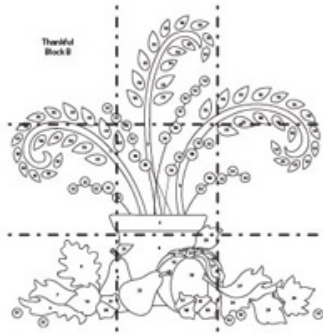
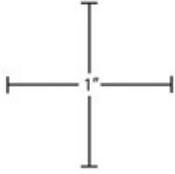

For all printable patterns or digital content: <http://tinyurl.com/11106->

patterns-download

# Thankful: block B

Note: Patterns are also printed in reverse for fusible appliqué.

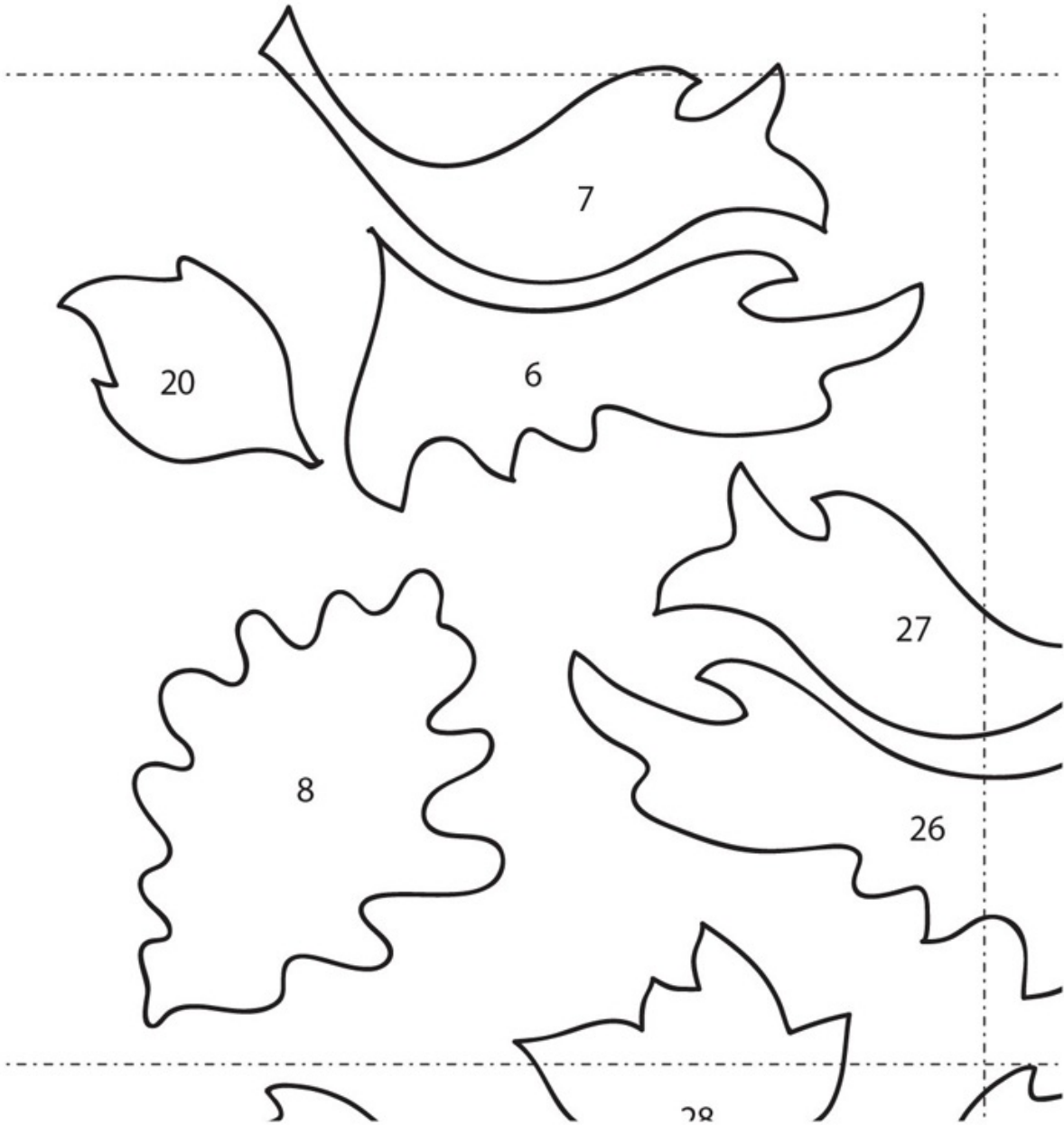
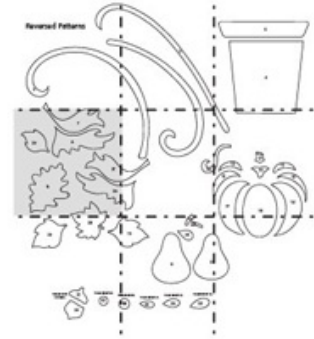
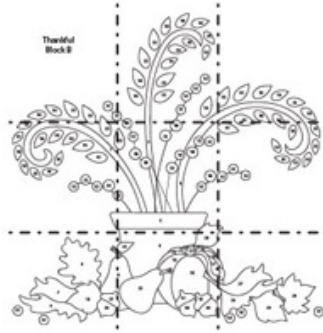
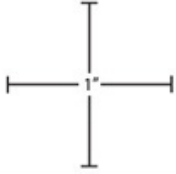

For all printable patterns or digital content: <http://tinyurl.com/11106-patterns-download>

## Thankful: block B

Note: Patterns are also printed in reverse for fusible appliqué.

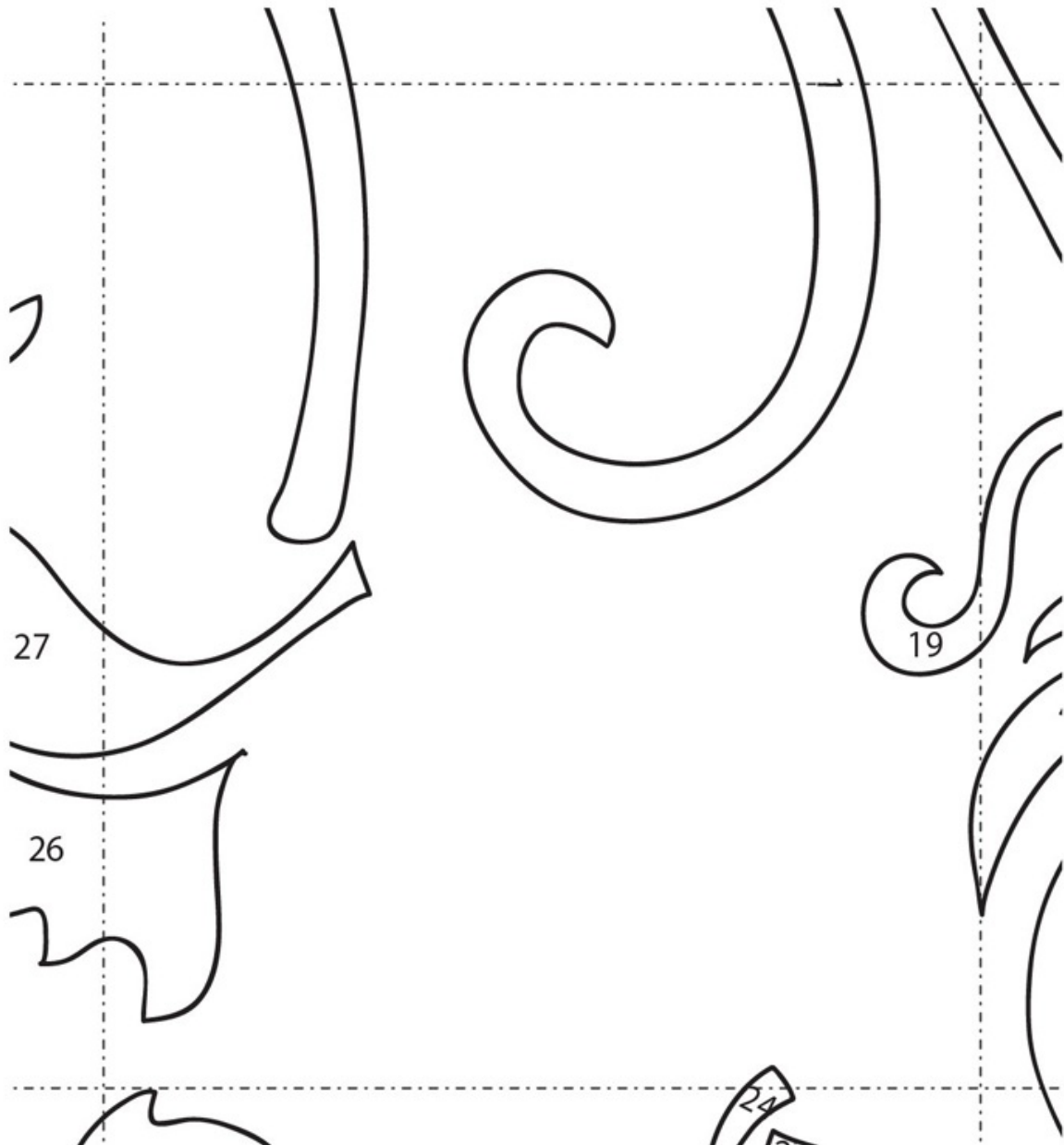
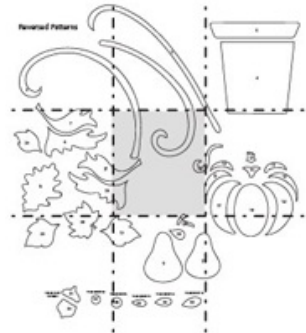
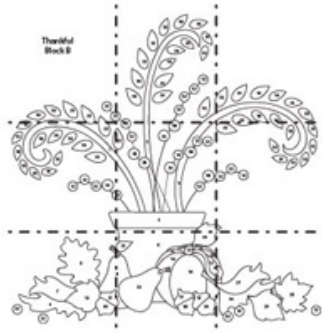
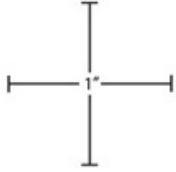

For all printable patterns or digital content: <http://tinyurl.com/11106->

patterns-download

## Thankful: block B

Note: Patterns are also printed in reverse for fusible appliqué.

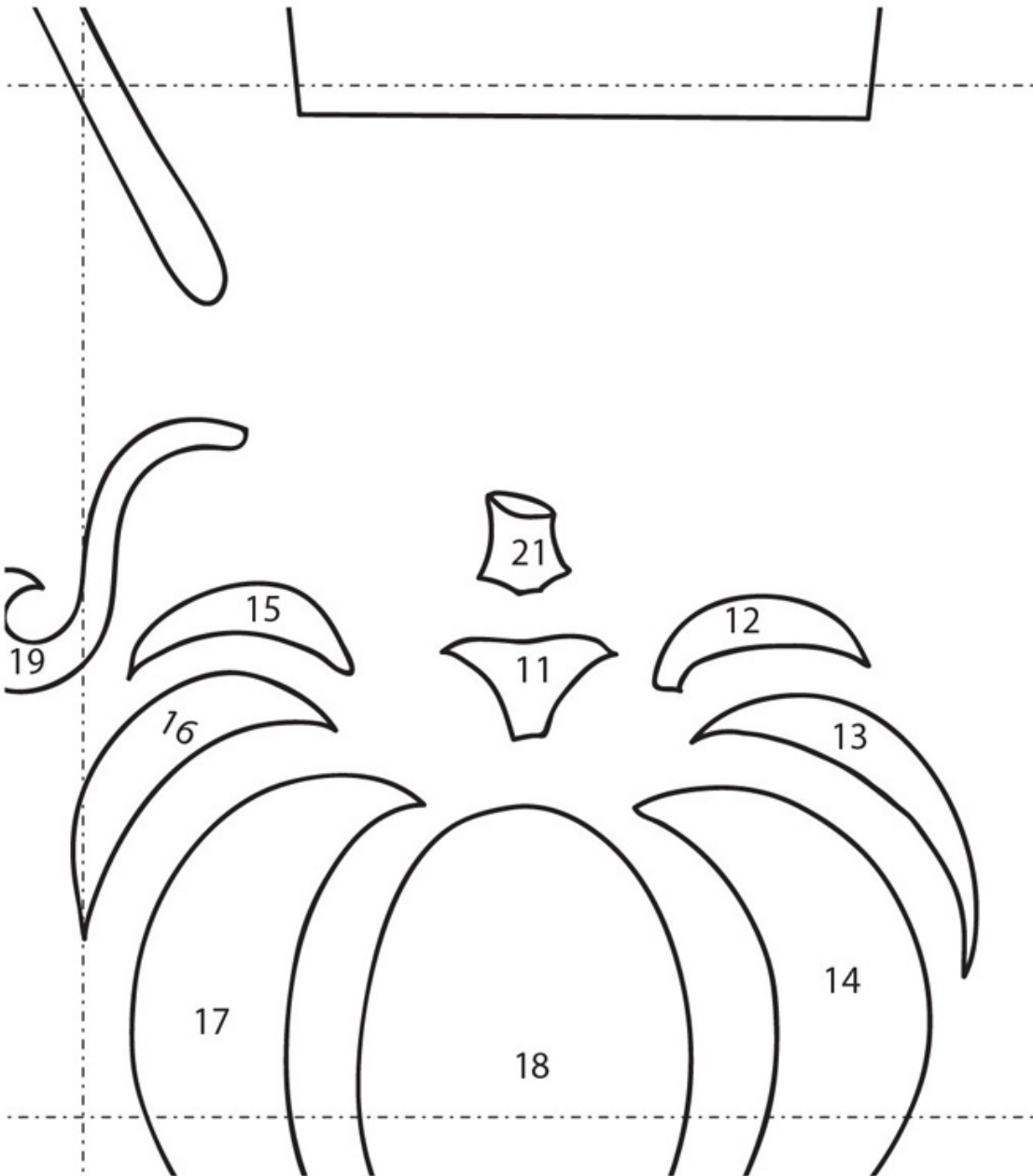
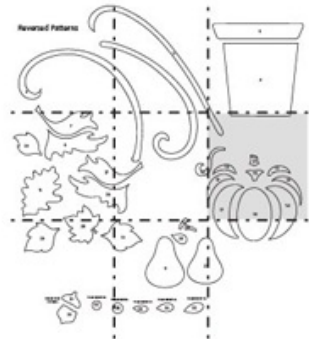
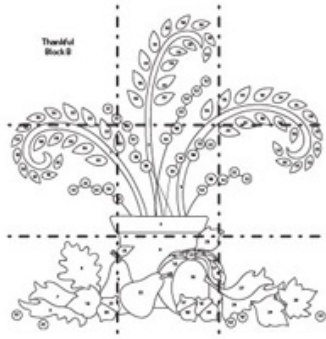
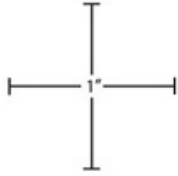

For all printable patterns or digital content: <http://tinyurl.com/11106-patterns-download>



# Thankful: block B

Note: Patterns are also printed in reverse for fusible appliqué.

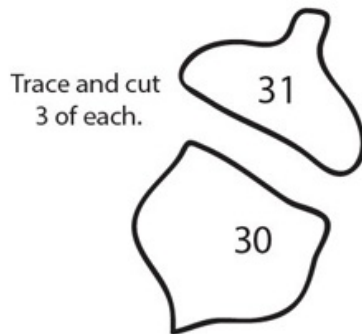
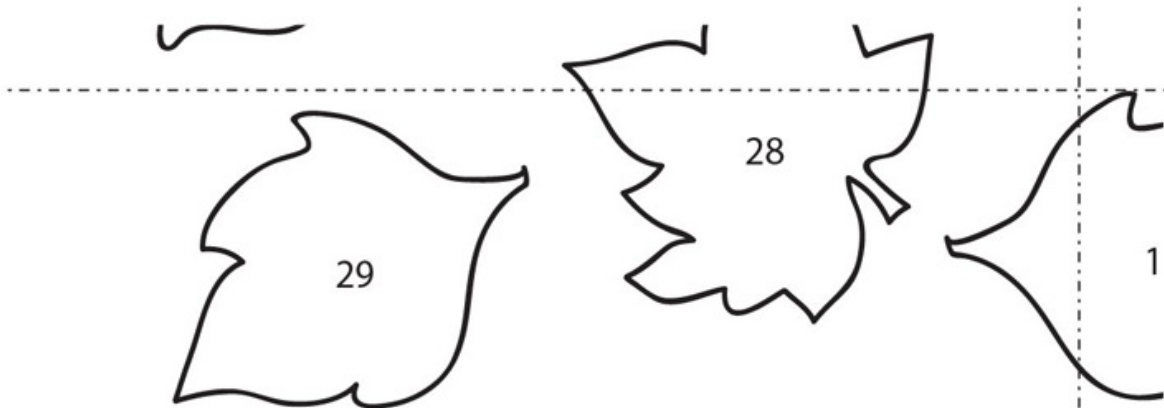
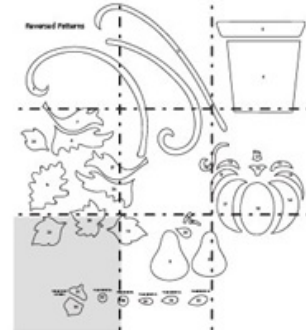
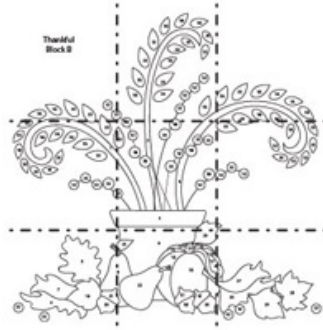
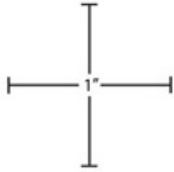

Trace and cut 24.



Trace and cut 1.



patterns-download

# Thankful: block B

Note: Patterns are also printed in reverse for fusible appliqué.

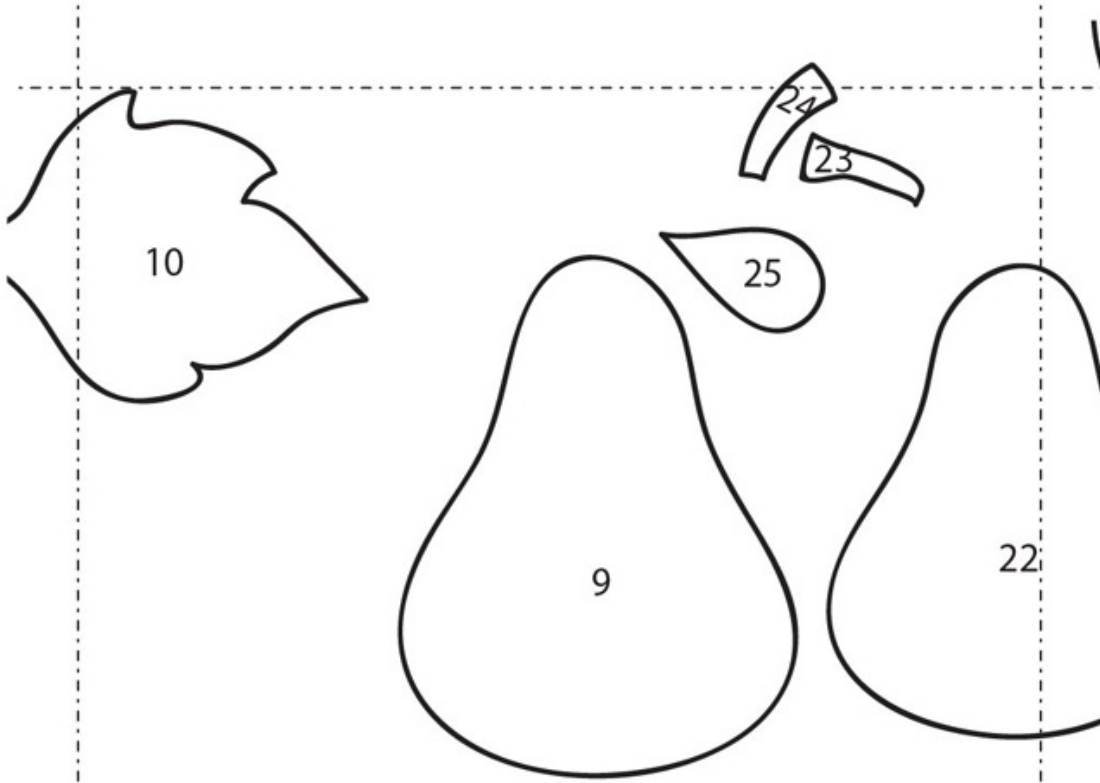
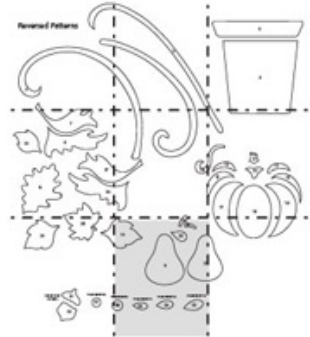
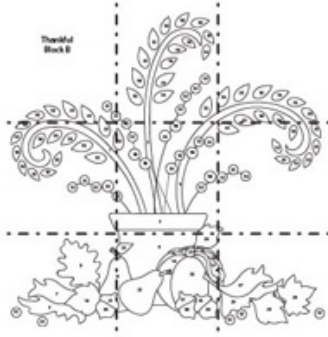
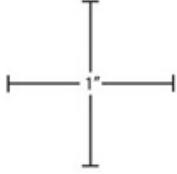

Trace and cut 8.



Trace and cut 17.



Trace and cut 15.



Trace and cut 18.



For all printable patterns or digital content: <http://tinyurl.com/11106-patterns-download>

## Thankful: block B

Note: Patterns are also printed in reverse for fusible appliqué.

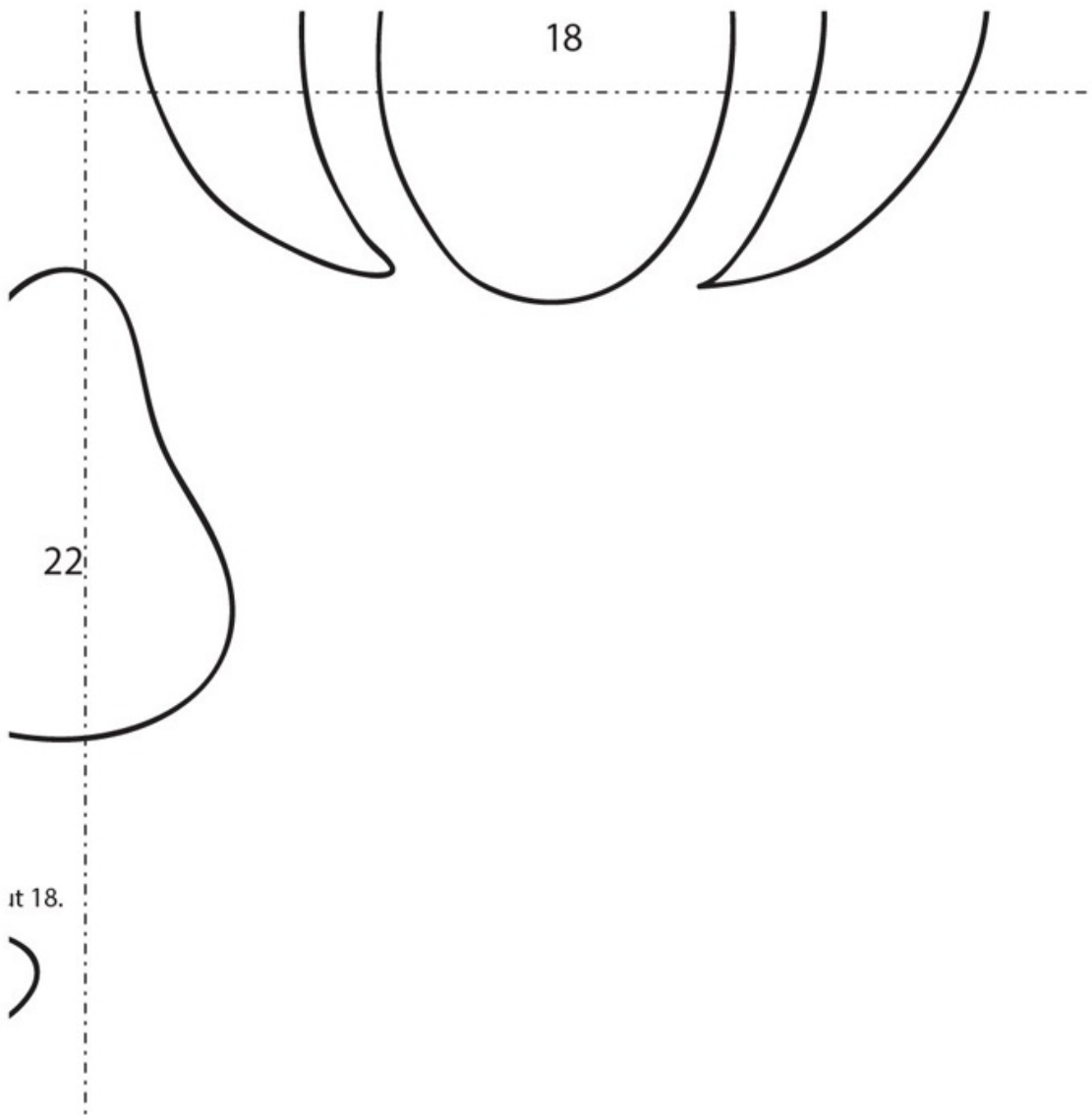
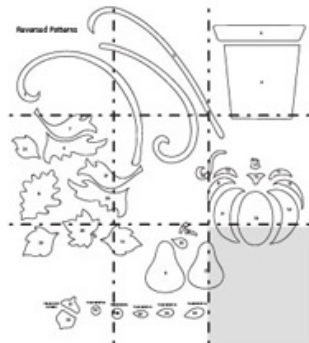
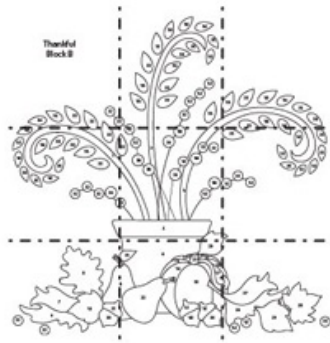
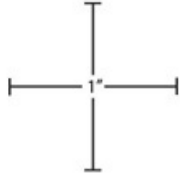

For all printable patterns or digital content: <http://tinyurl.com/11106->

patterns-download

## Thankful: block C

Note: Patterns are also printed in reverse for fusible appliqué.

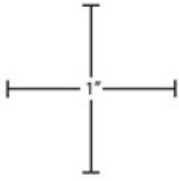

To make complete pattern, join the following pages, following the diagram for reference.

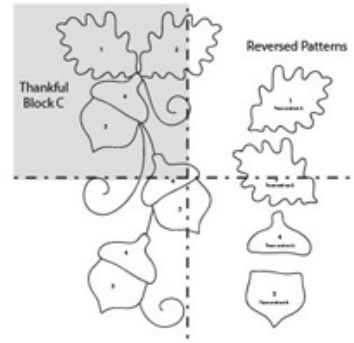

## Thankful Block C

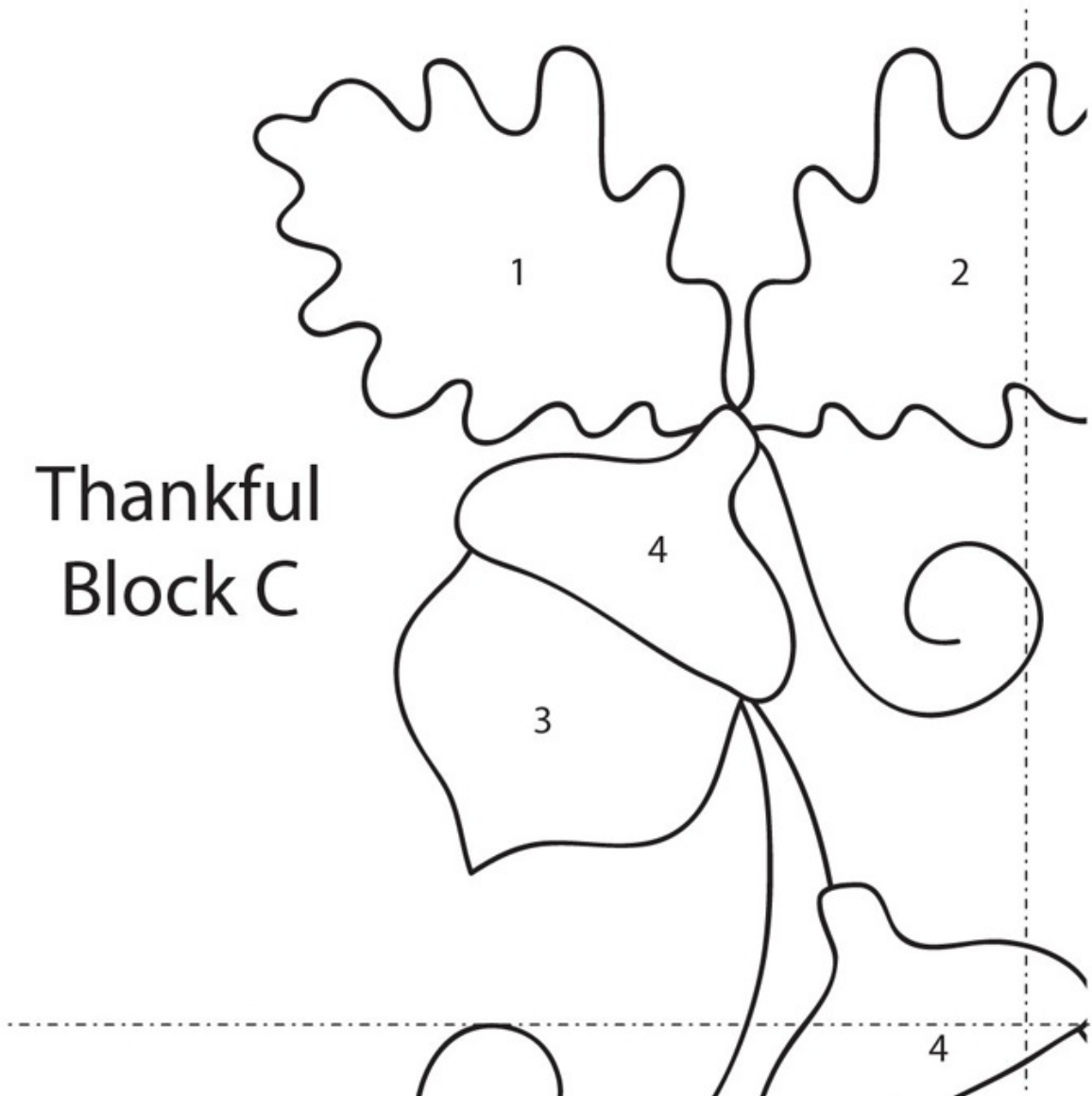

For all printable patterns or digital content: <http://tinyurl.com/11106-patterns-download>



# Thankful: block C

Note: Patterns are also printed in reverse for fusible appliqué.

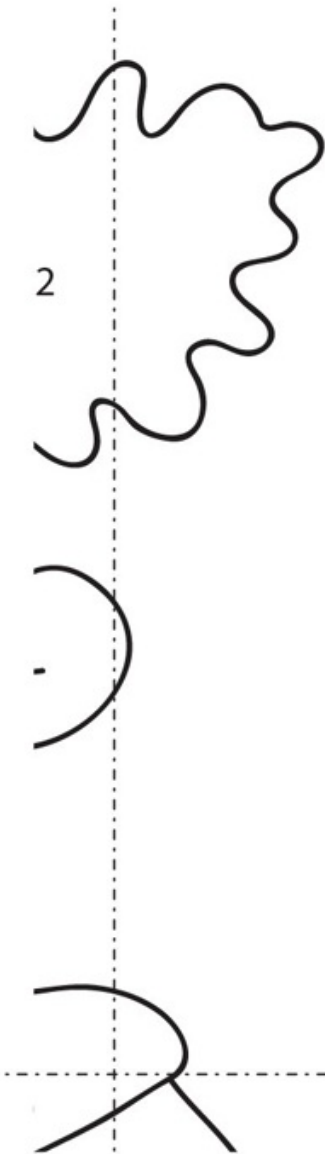
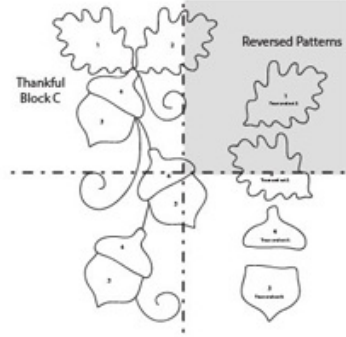
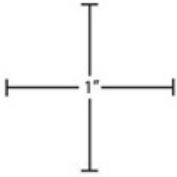

## Reversed Patterns

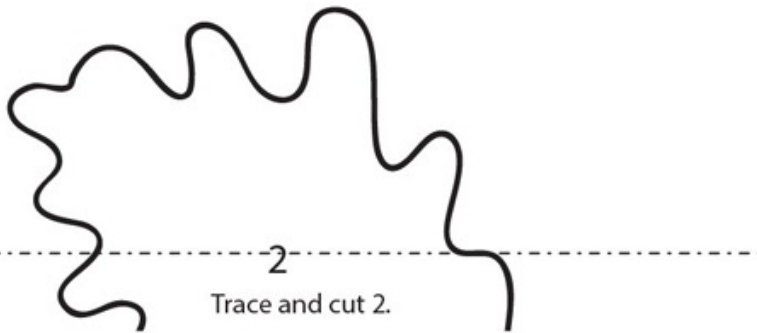
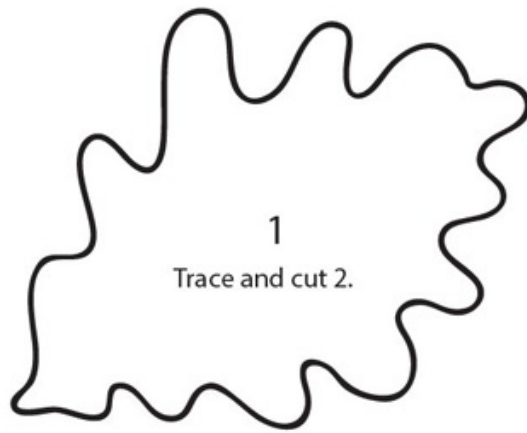

For all printable patterns or digital content: <http://tinyurl.com/11106-patterns-download>

## Thankful: block C

Note: Patterns are also printed in reverse for fusible appliqué.

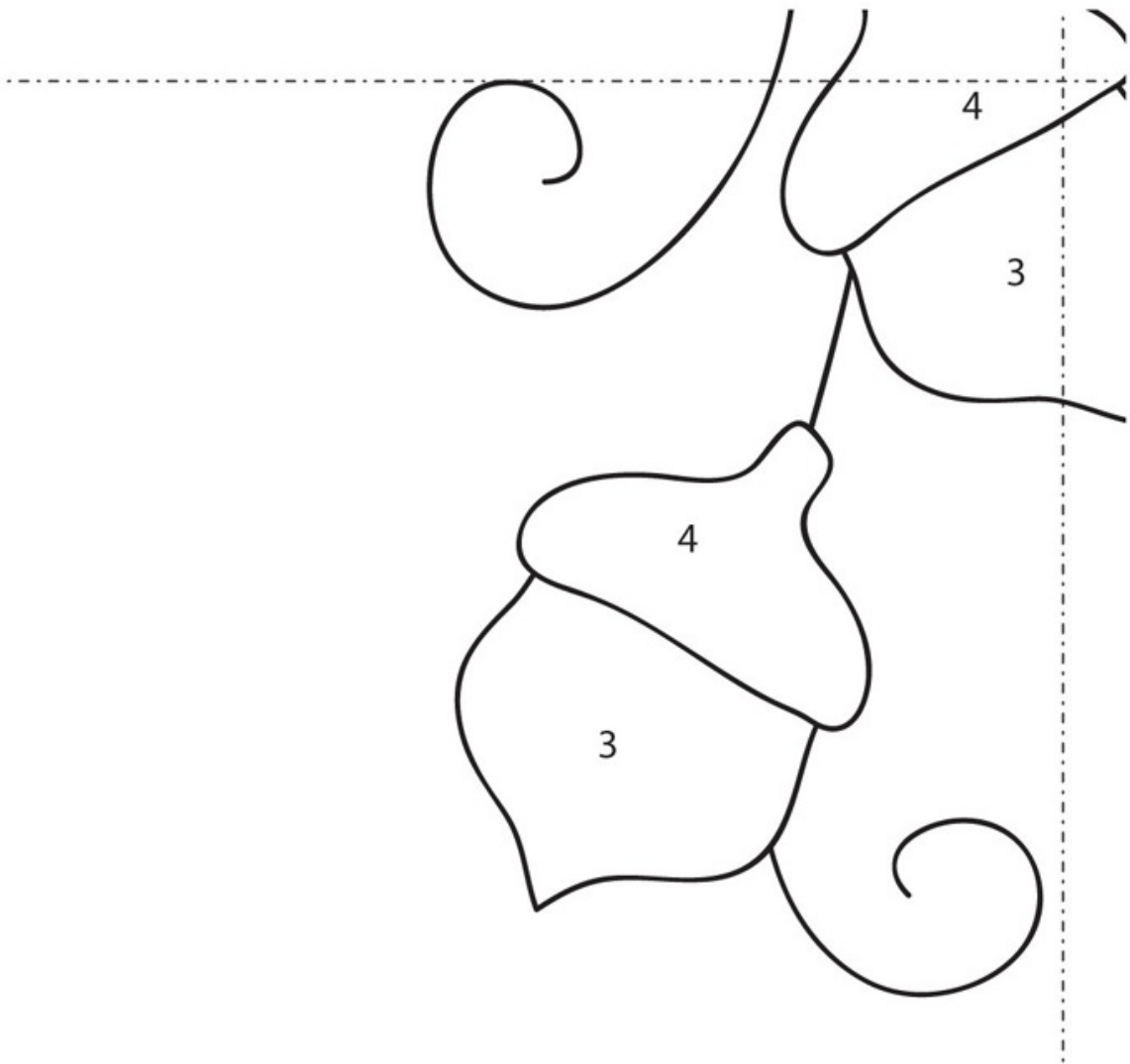
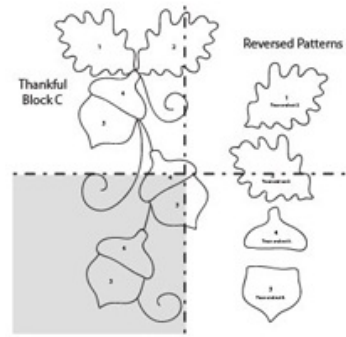
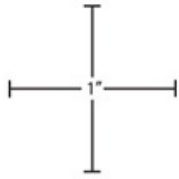

For all printable patterns or digital content: <http://tinyurl.com/11106->

**Thankful: block C**

*Note: Patterns are also printed in reverse for fusible appliqué.*

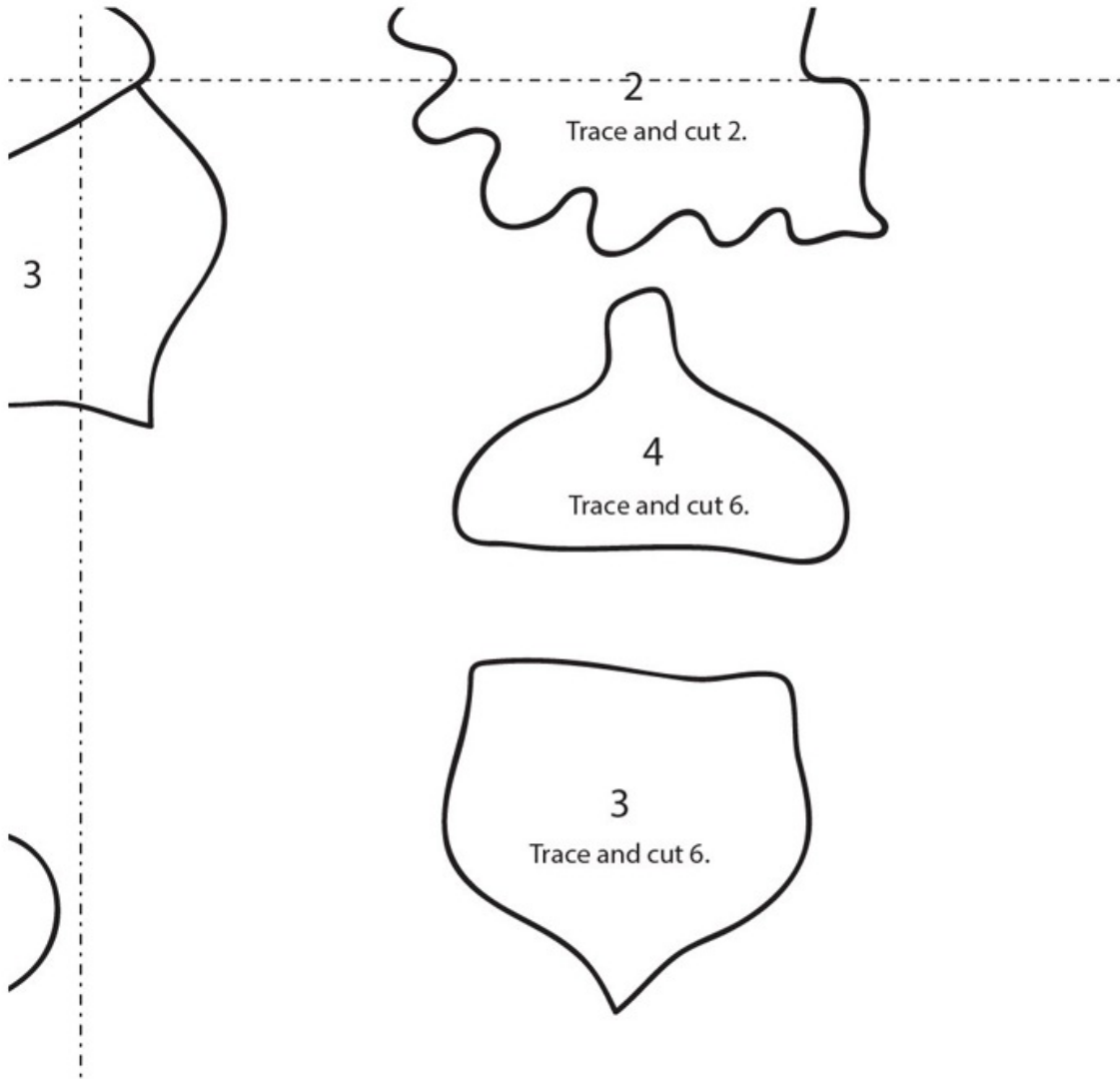
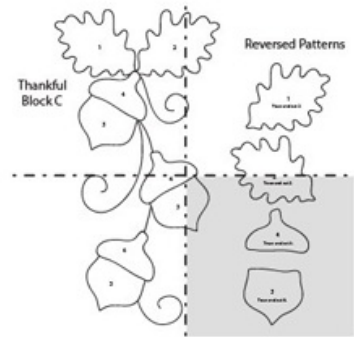
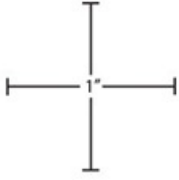

patterns-download

**Thankful: block D**

*Note: Patterns are also printed in reverse for fusible appliqué.*

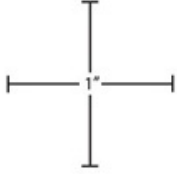

To make complete pattern, join the following pages, following the diagram for reference.

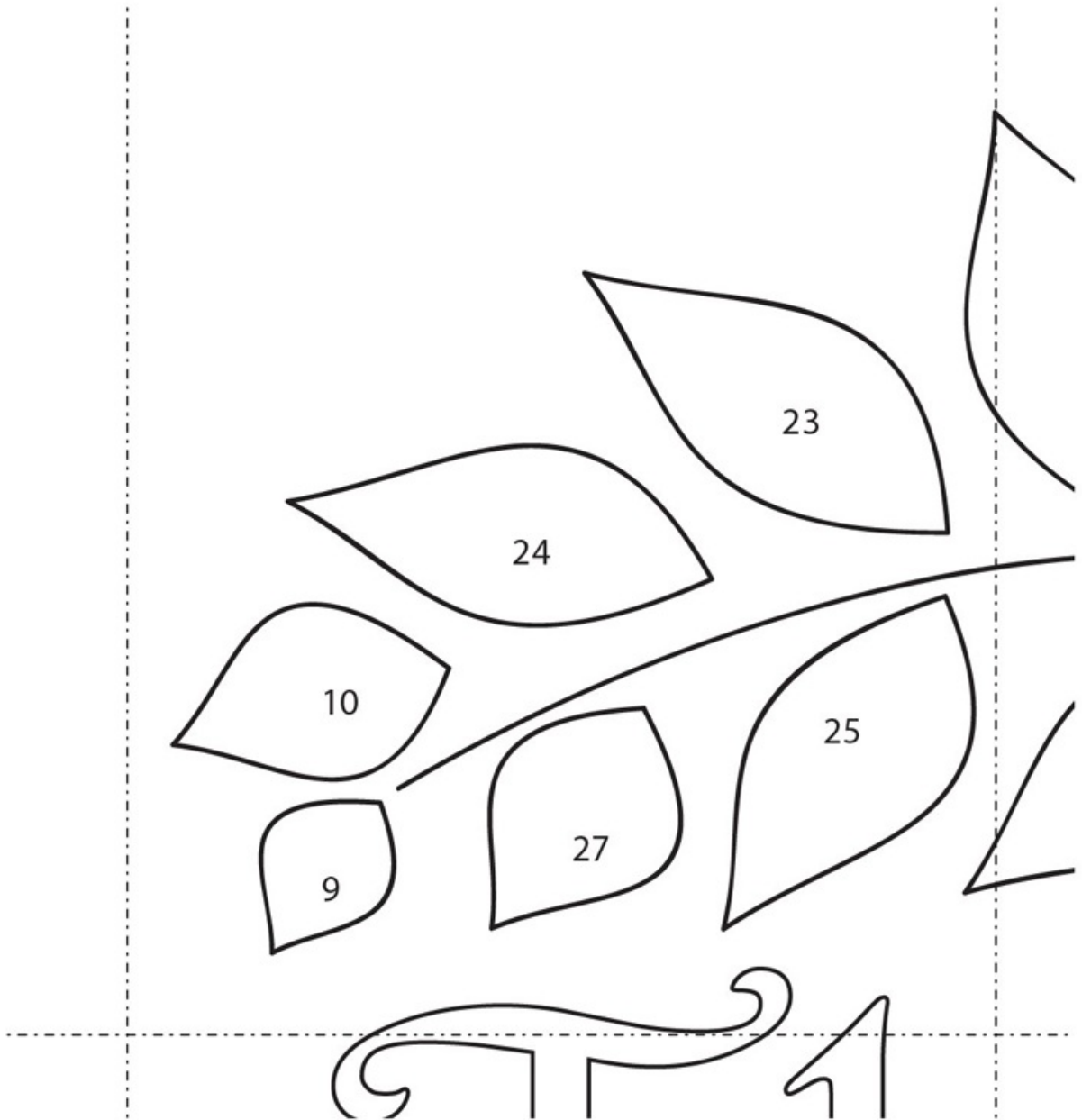
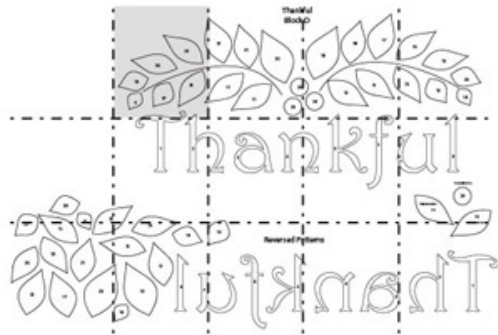

For all printable patterns or digital content: <http://tinyurl.com/11106-patterns-download>

## Thankful: block D

Note: Patterns are also printed in reverse for fusible appliqué.

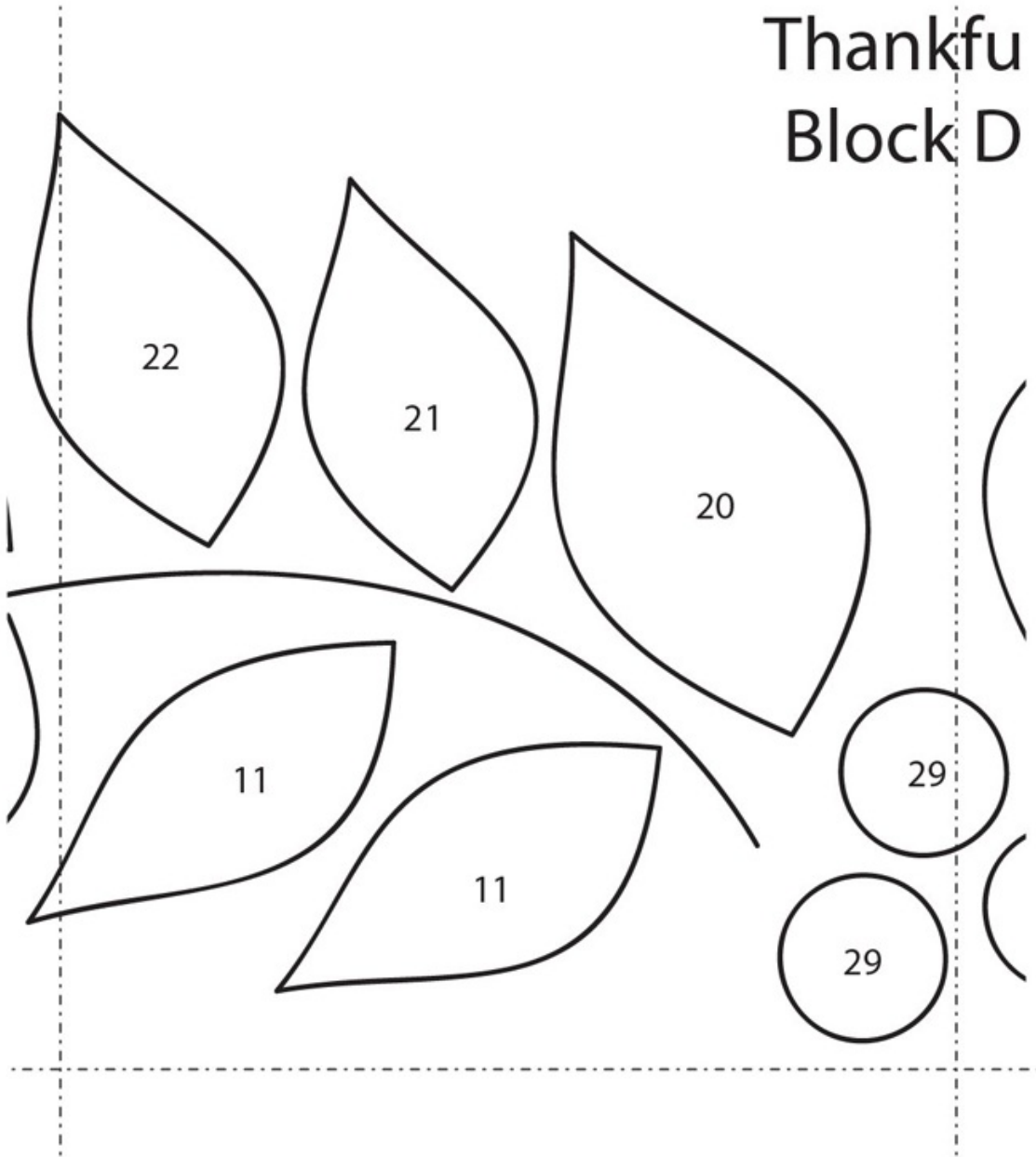
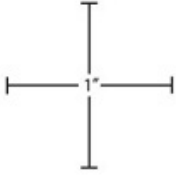

For all printable patterns or digital content: <http://tinyurl.com/11106-patterns-download>



# Thankful: block D

Note: Patterns are also printed in reverse for fusible appliqué.

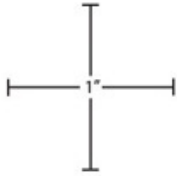

Thankful  
Block D

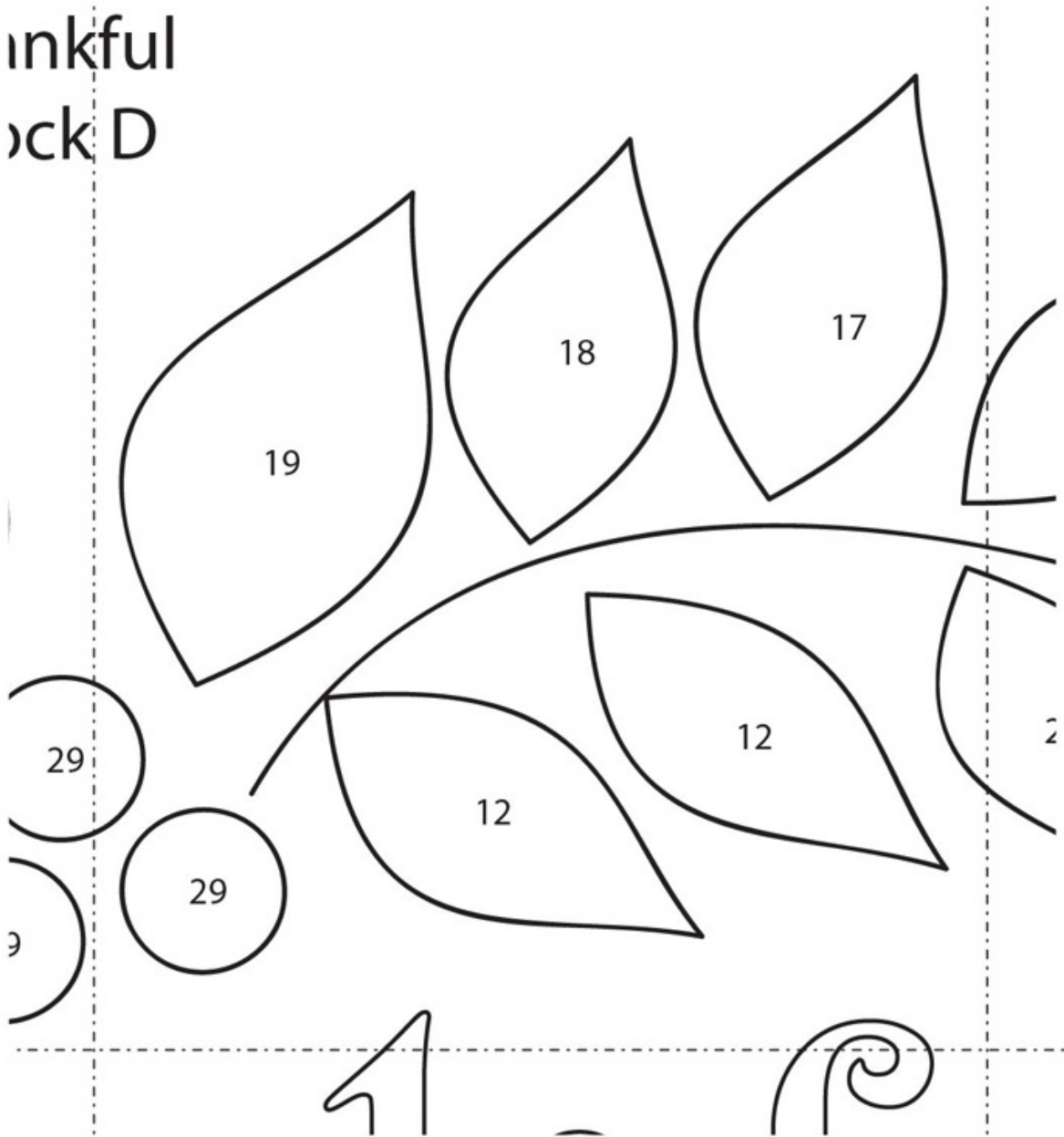

For all printable patterns or digital content: <http://tinyurl.com/11106-patterns-download>

# Thankful: block D

Note: Patterns are also printed in reverse for fusible appliqué.

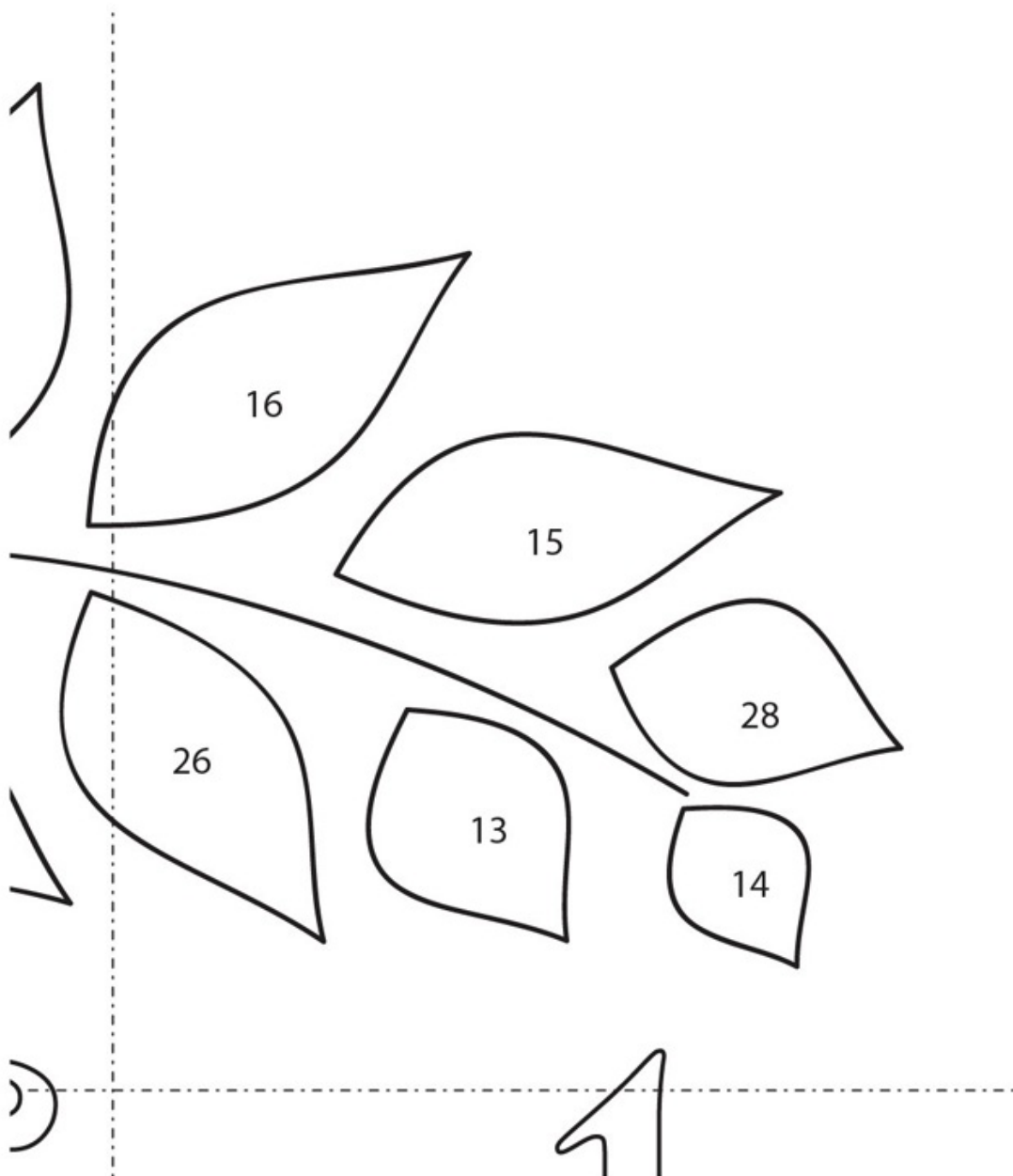
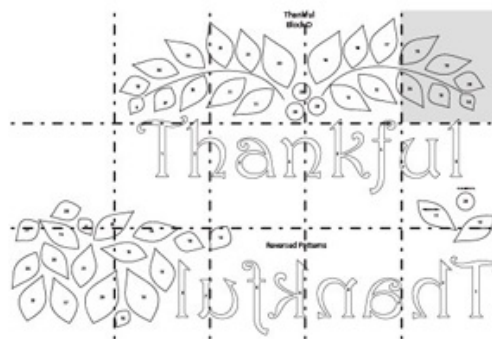
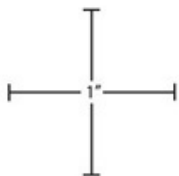

For all printable patterns or digital content: <http://tinyurl.com/11106-patterns-download>

## Thankful: block D

Note: Patterns are also printed in reverse for fusible appliqué.

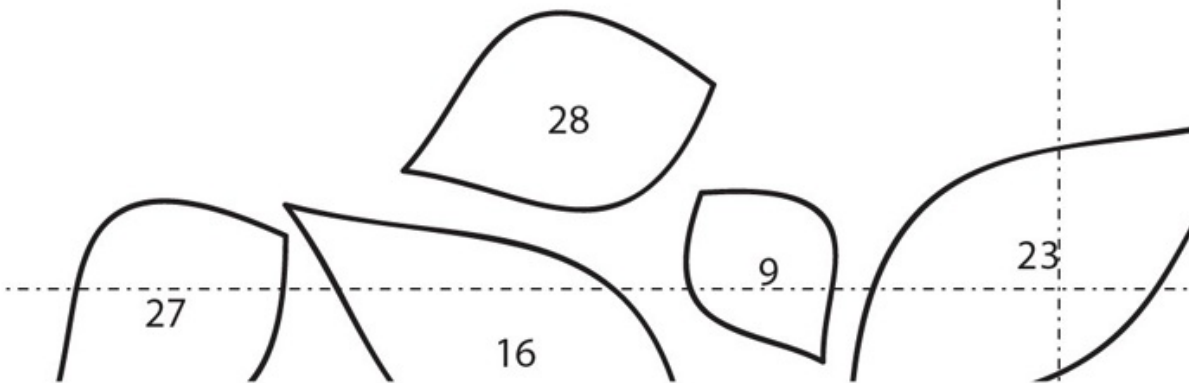
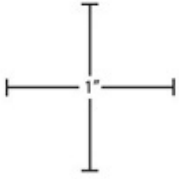

For all printable patterns or digital content: <http://tinyurl.com/11106-patterns-download>

# Thankful: block D

Note: Patterns are also printed in reverse for fusible appliqué.

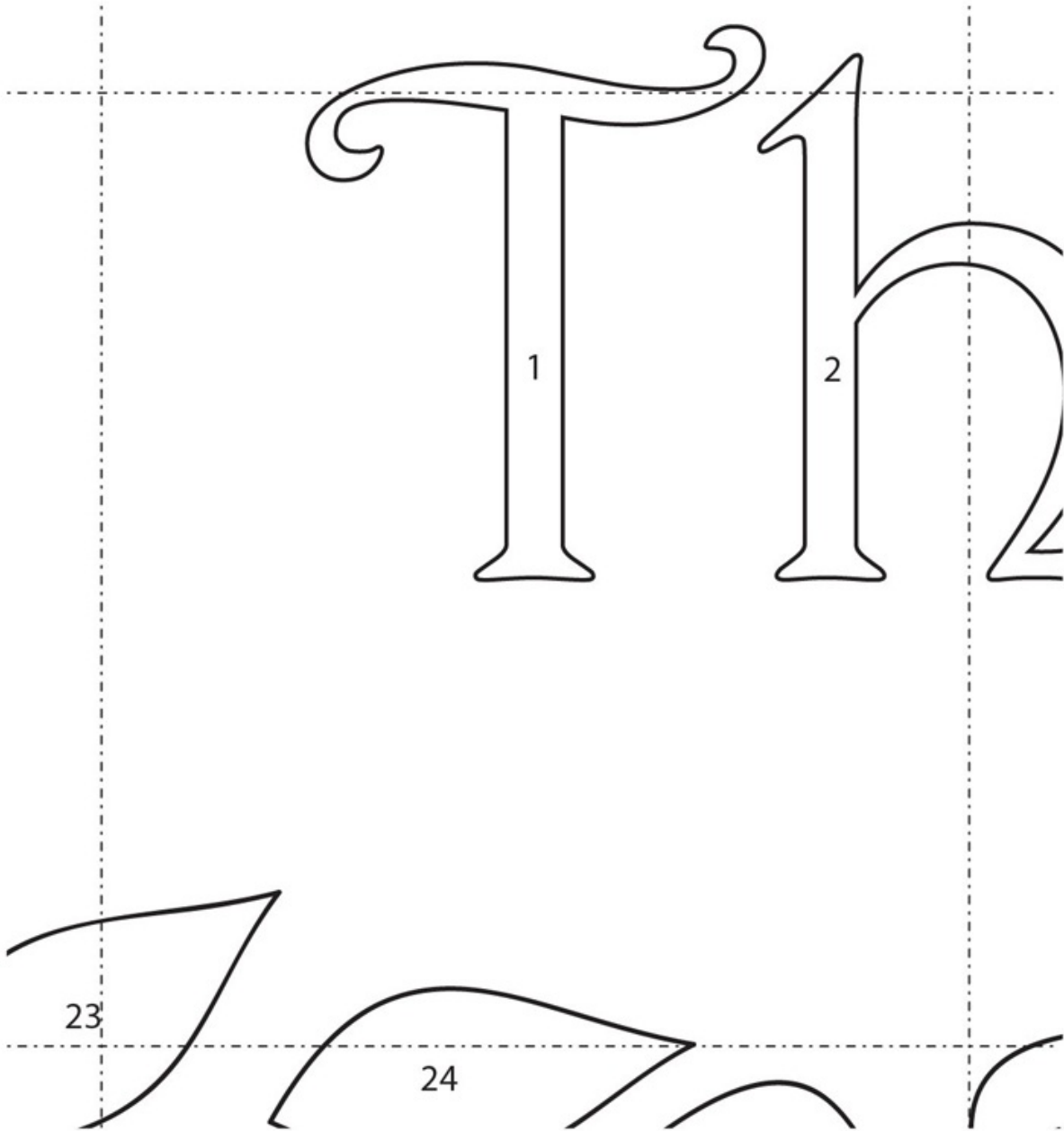
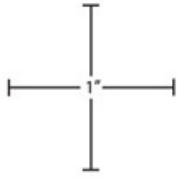

For all printable patterns or digital content: <http://tinyurl.com/11106-patterns-download>



# Thankful: block D

Note: Patterns are also printed in reverse for fusible appliqué.

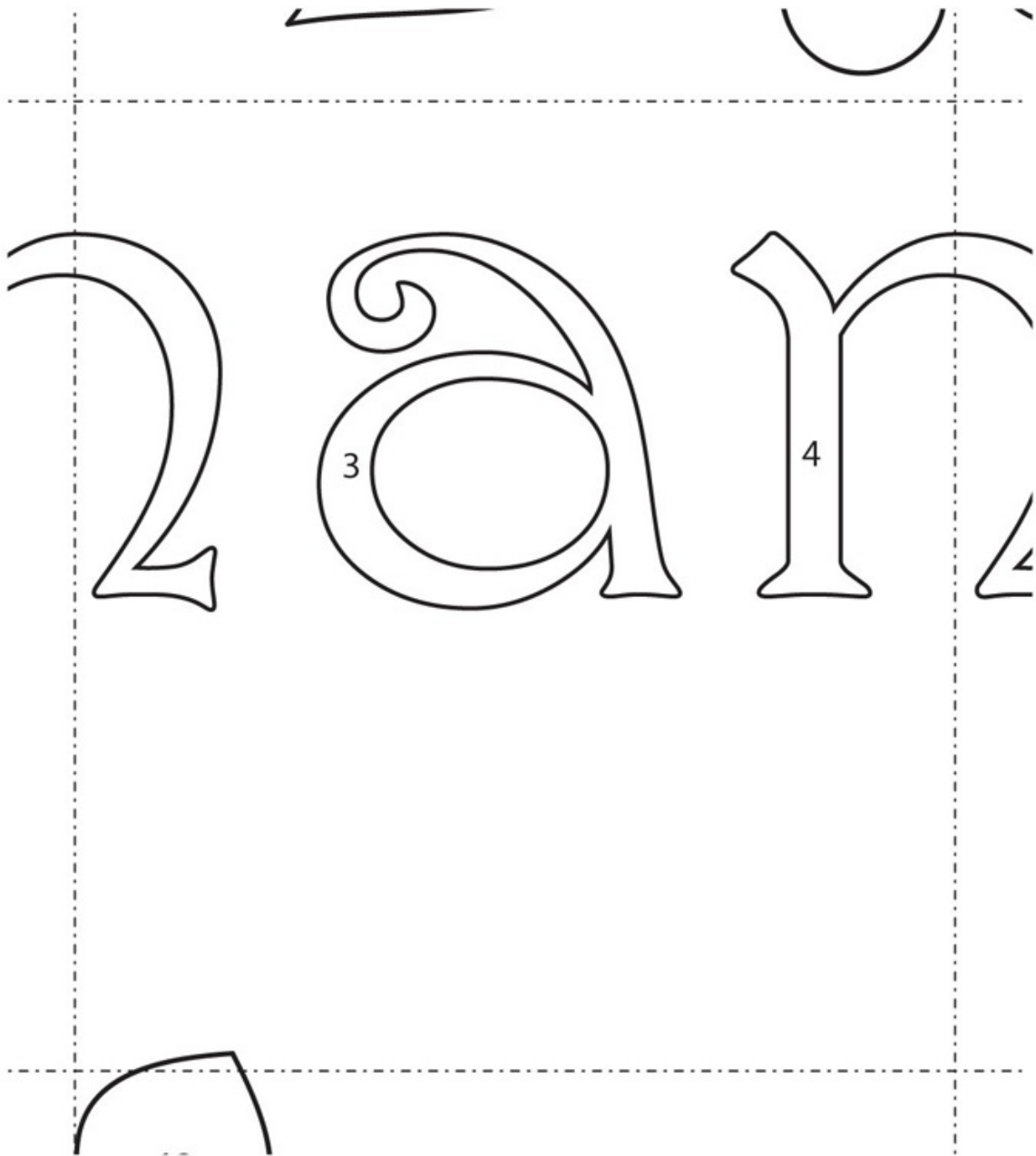
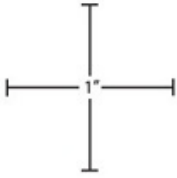

For all printable patterns or digital content: <http://tinyurl.com/11106-patterns-download>

# Thankful: block D

Note: Patterns are also printed in reverse for fusible appliqué.

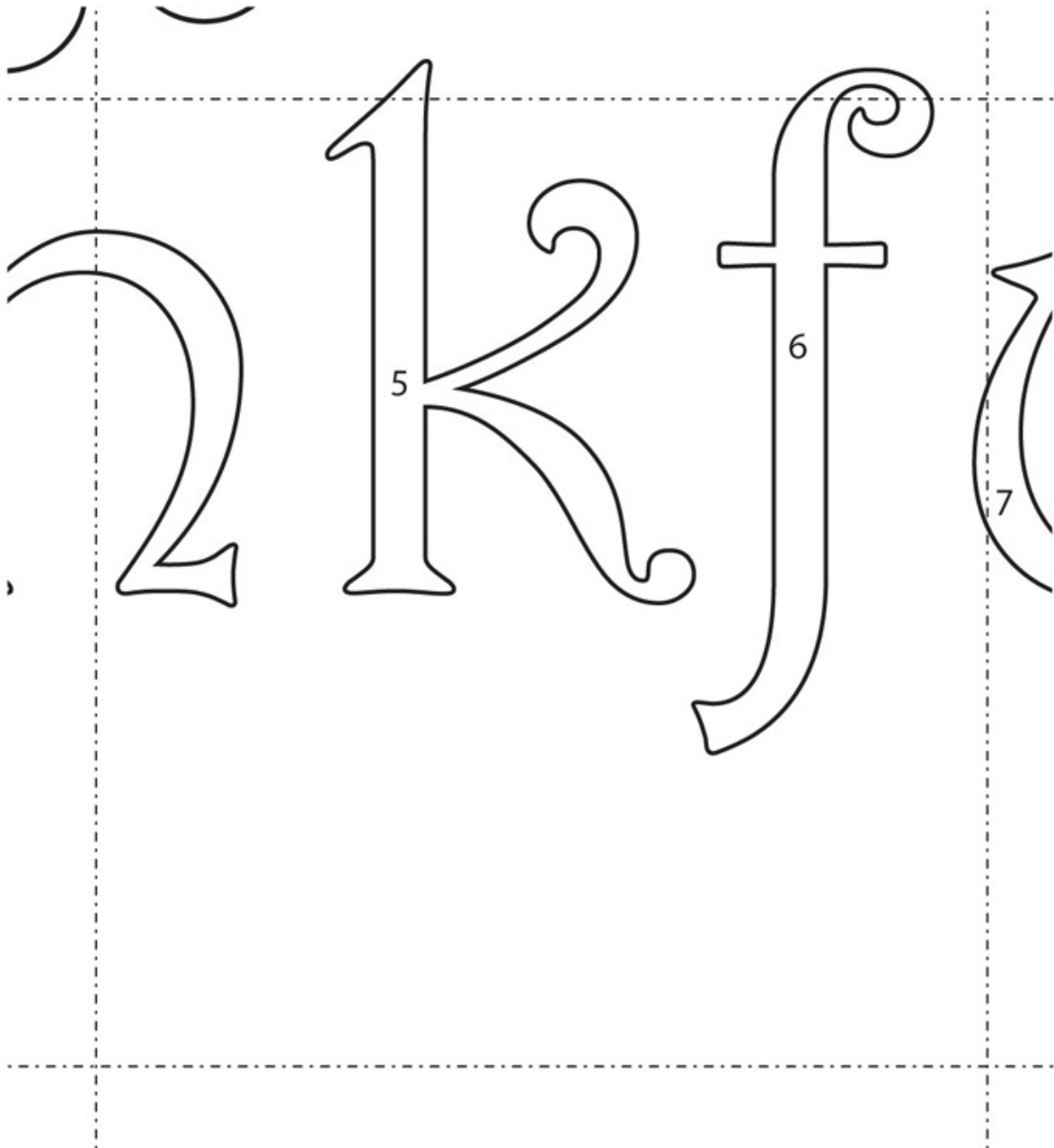
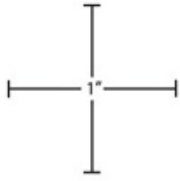

For all printable patterns or digital content: <http://tinyurl.com/11106-patterns-download>

# Thankful: block D

Note: Patterns are also printed in reverse for fusible appliqué.

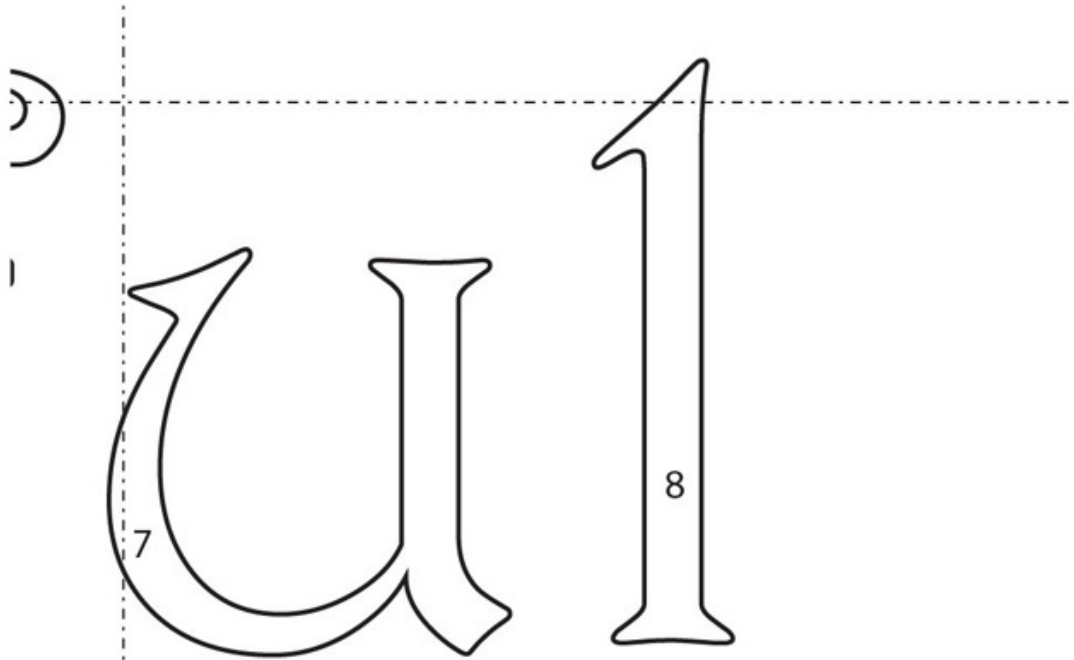
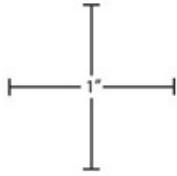

Trace and cut 3.

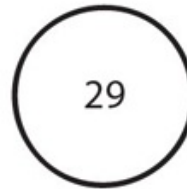

Trace and cut 2.

11

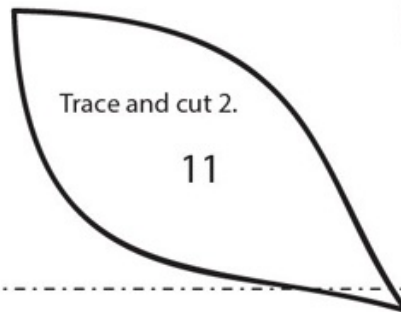

12

Trace and cut 2.

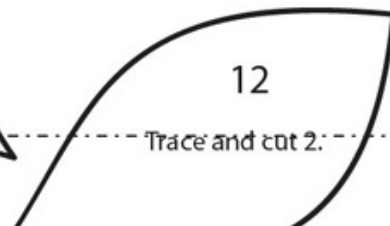

For all printable patterns or digital content: <http://tinyurl.com/11106-patterns-download>

# Thankful: block D

Note: Patterns are also printed in reverse for fusible appliqué.

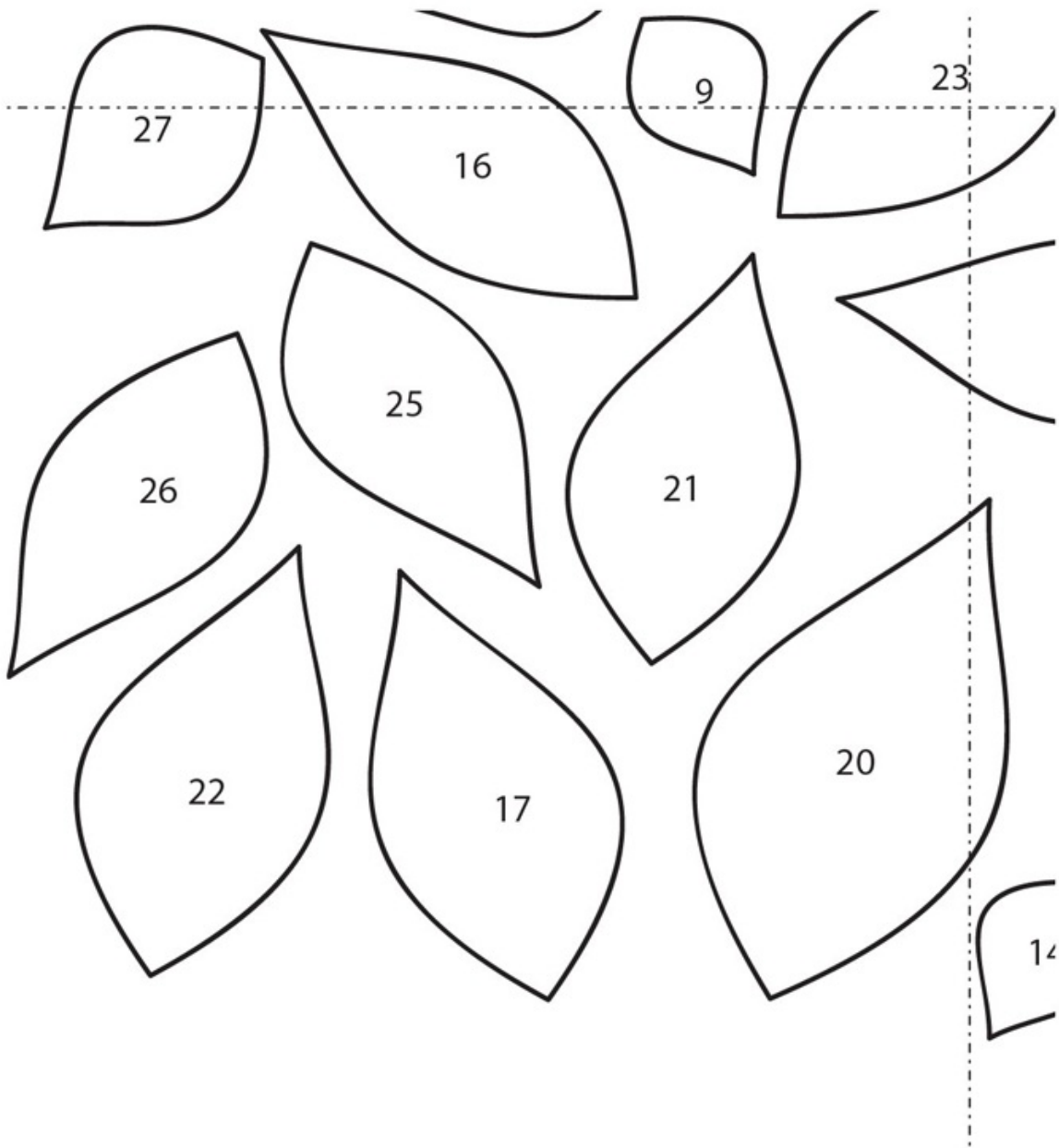
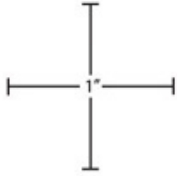

For all printable patterns or digital content: <http://tinyurl.com/11106-patterns-download>



# Thankful: block D

Note: Patterns are also printed in reverse for fusible appliqué.

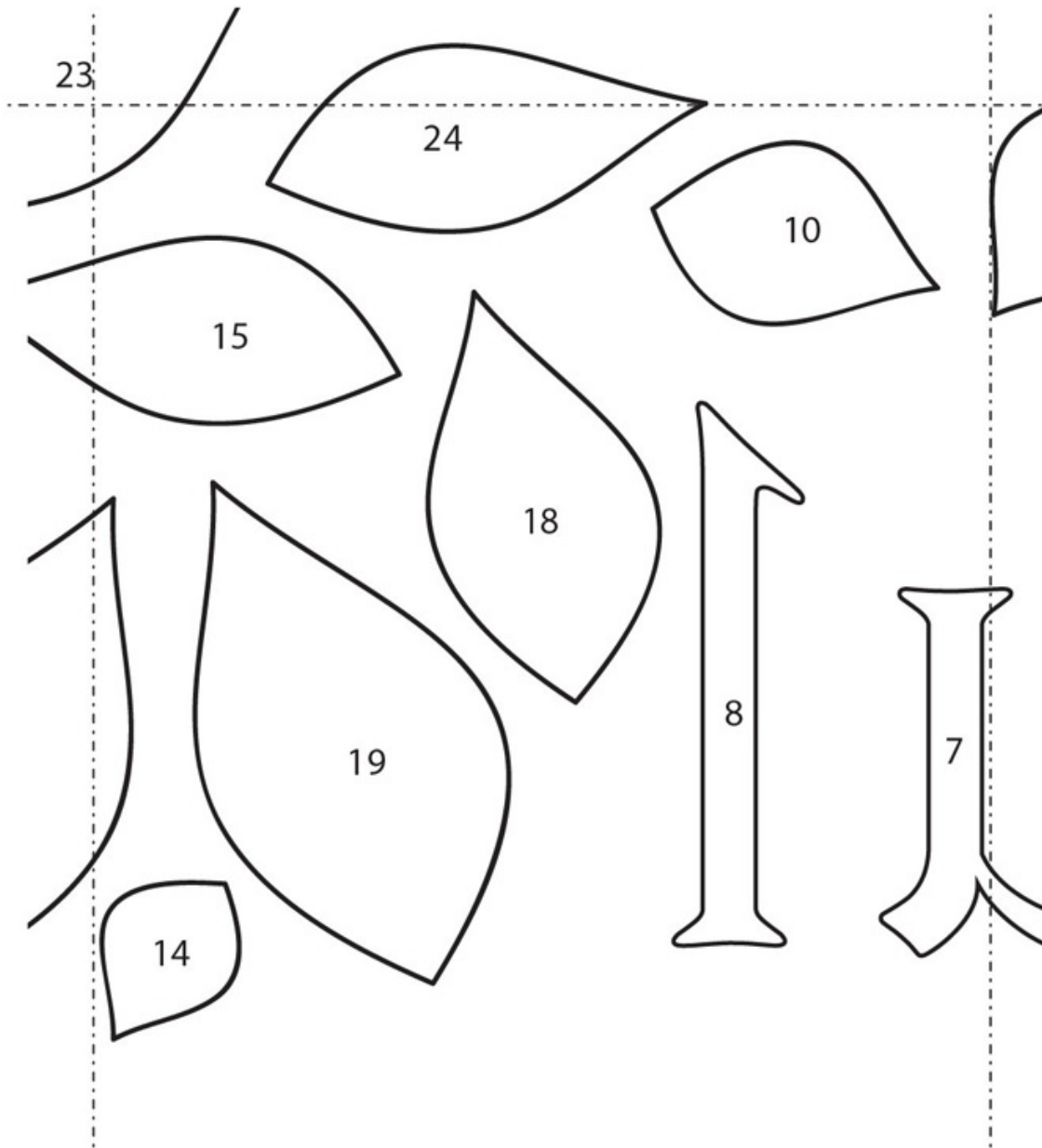
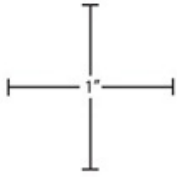

For all printable patterns or digital content: <http://tinyurl.com/11106-patterns-download>

# Thankful: block D

Note: Patterns are also printed in reverse for fusible appliqué.

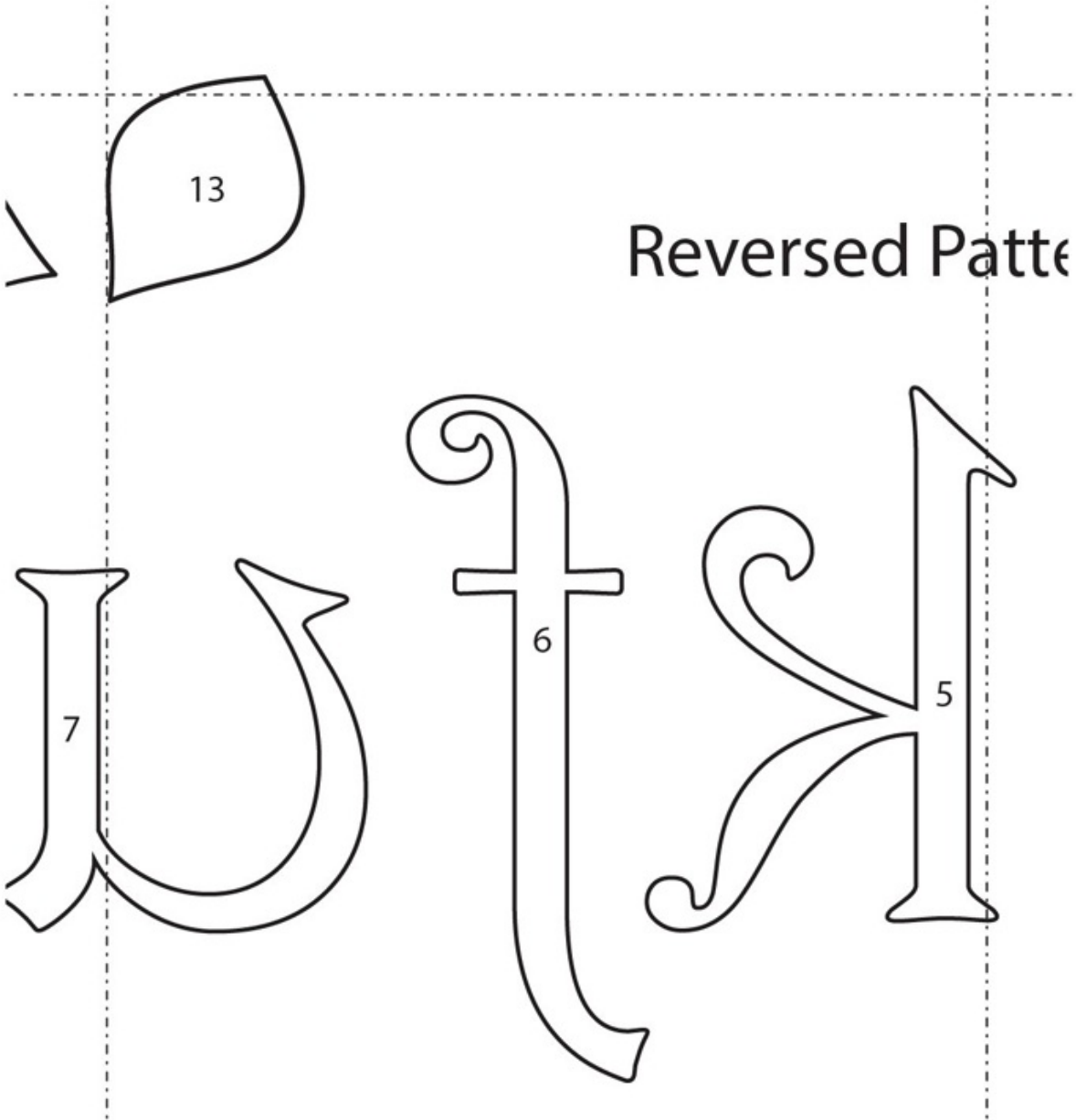
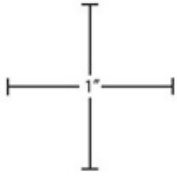

For all printable patterns or digital content: <http://tinyurl.com/11106-patterns-download>

## Thankful: block D

Note: Patterns are also printed in reverse for fusible appliqué.

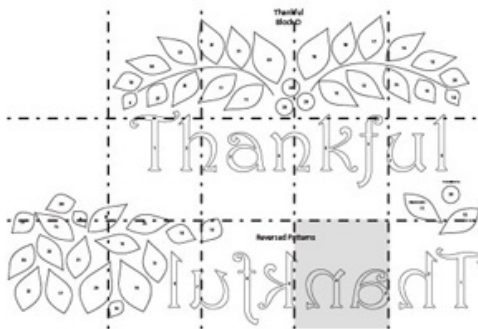
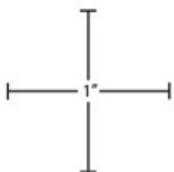

## D Patterns

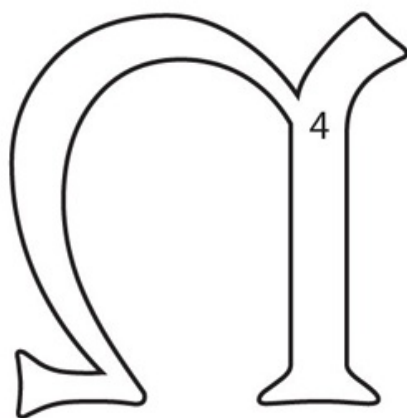
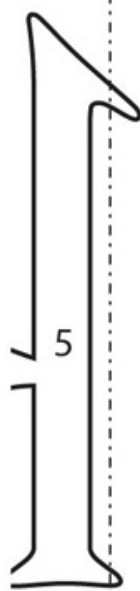

patterns-download

# Thankful: block D

Note: Patterns are also printed in reverse for fusible appliqué.

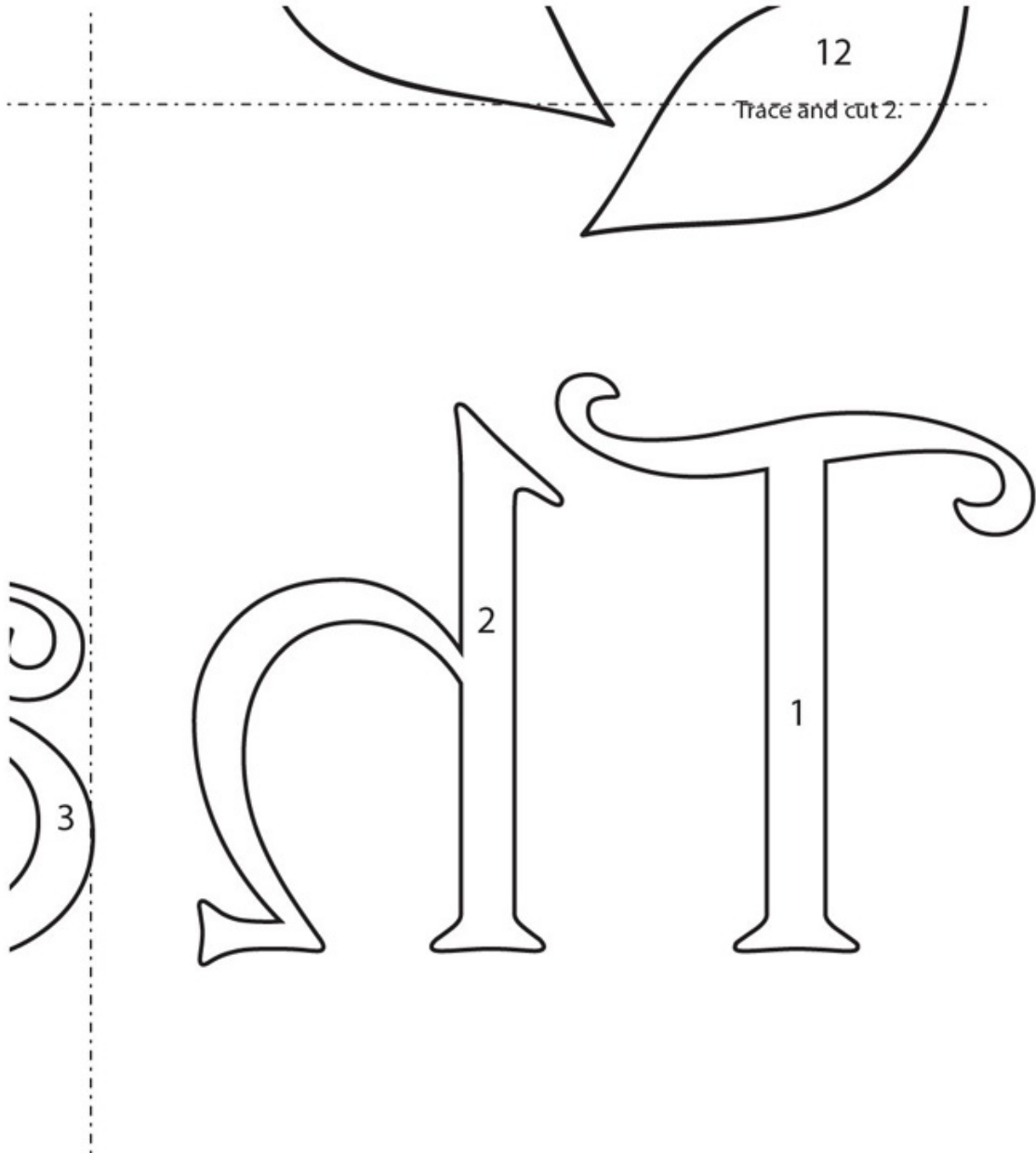
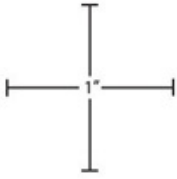

For all printable patterns or digital content: <http://tinyurl.com/11106-patterns-download>



## Merry and Bright: block A

Note: Patterns are also printed in reverse for fusible appliqué.

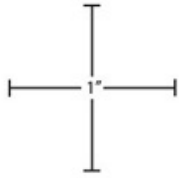

To make complete pattern, join the following pages, following the diagram for reference.

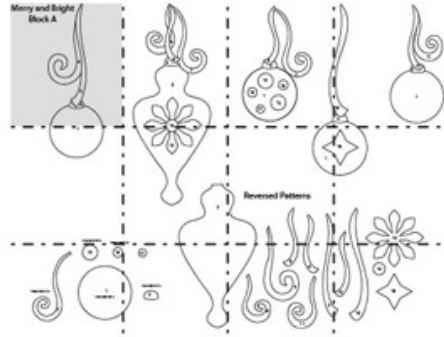

# Merry and Bright Block A

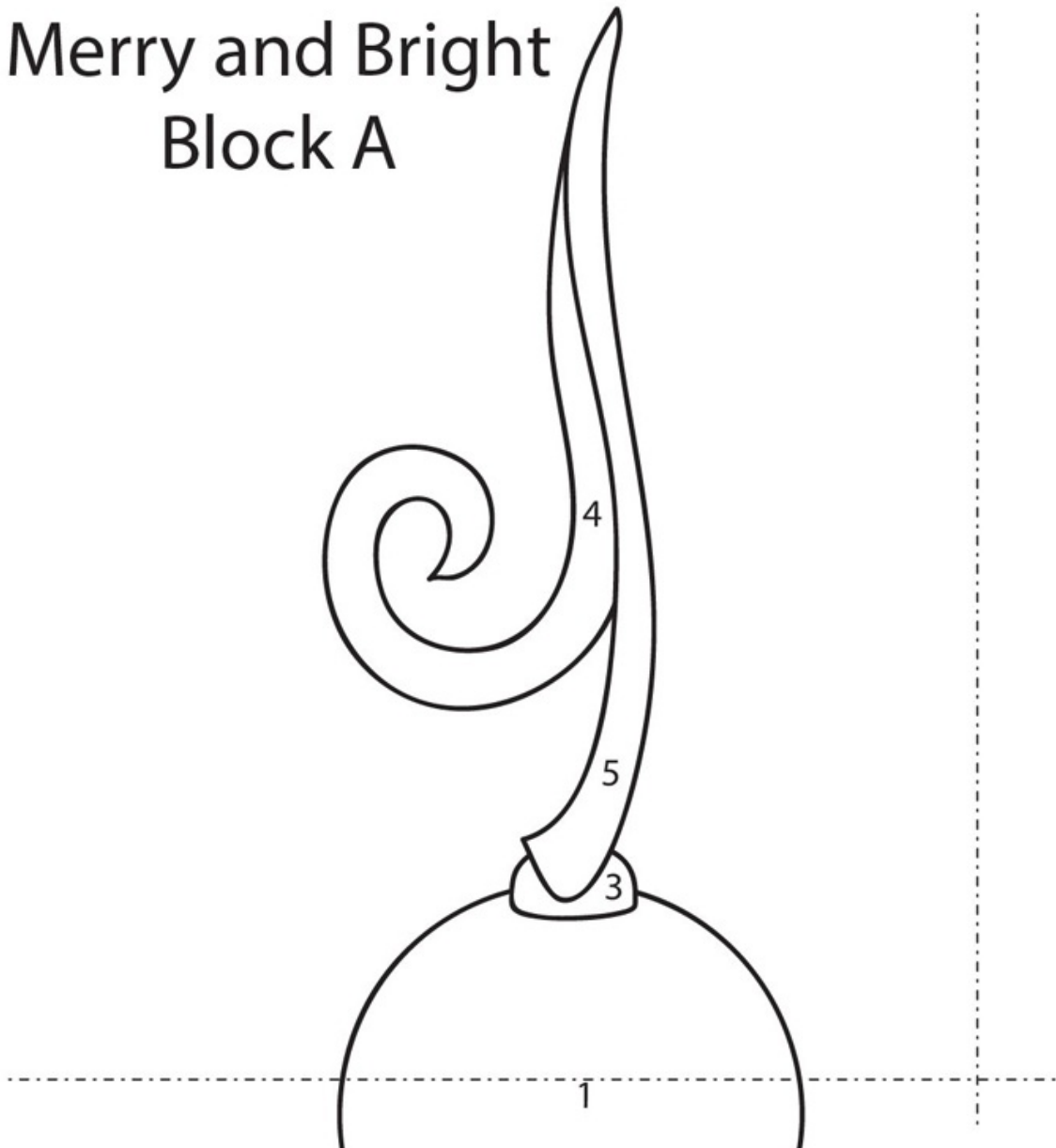

For all printable patterns or digital content: <http://tinyurl.com/11106->

patterns-download

## Merry and Bright: block A

Note: Patterns are also printed in reverse for fusible appliqué.

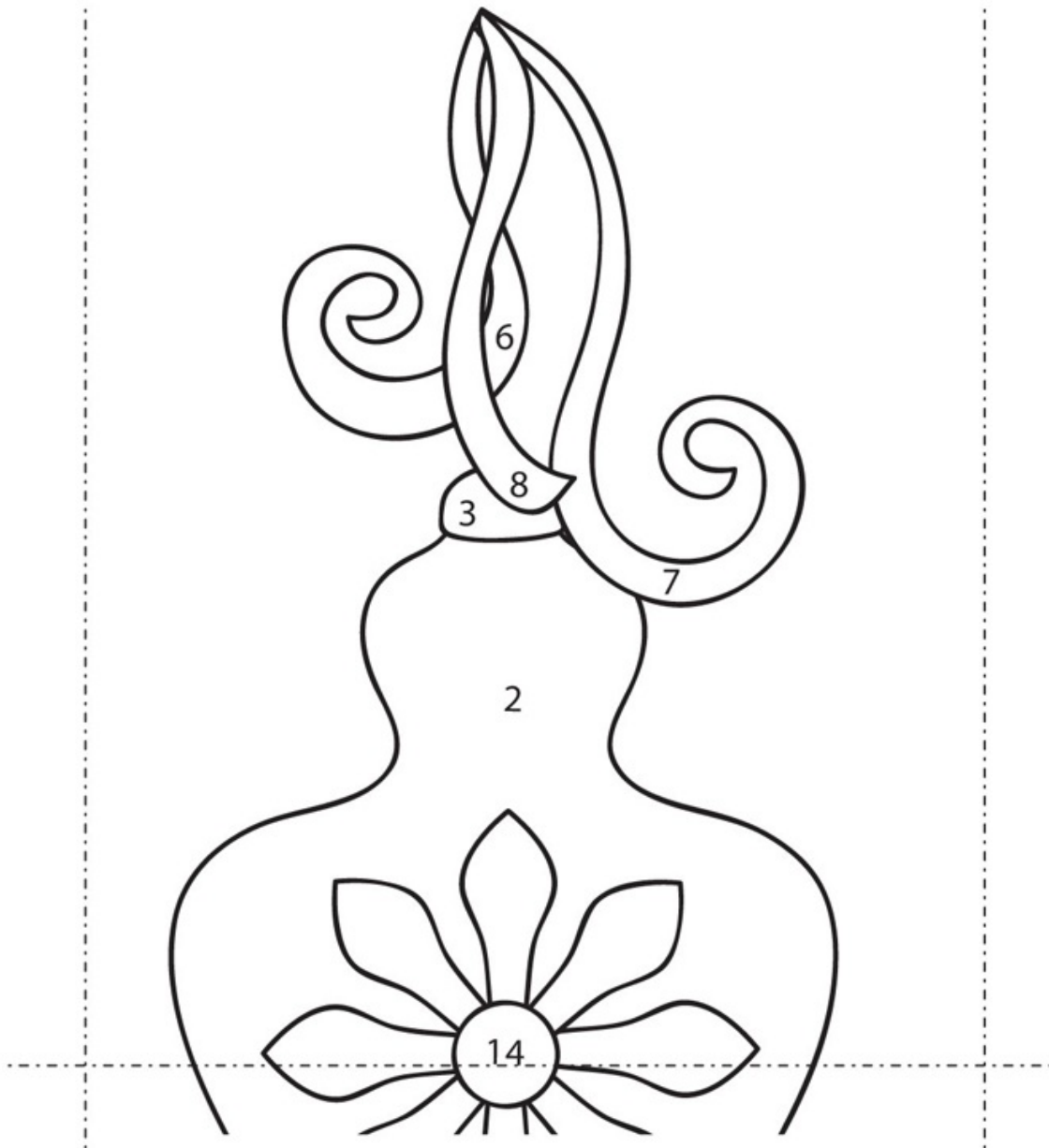
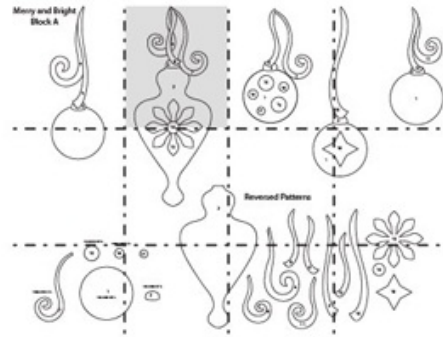
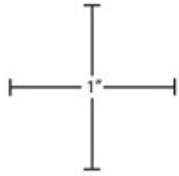

For all printable patterns or digital content: <http://tinyurl.com/11106-patterns-download>

# Merry and Bright: block A

Note: Patterns are also printed in reverse for fusible appliqué.

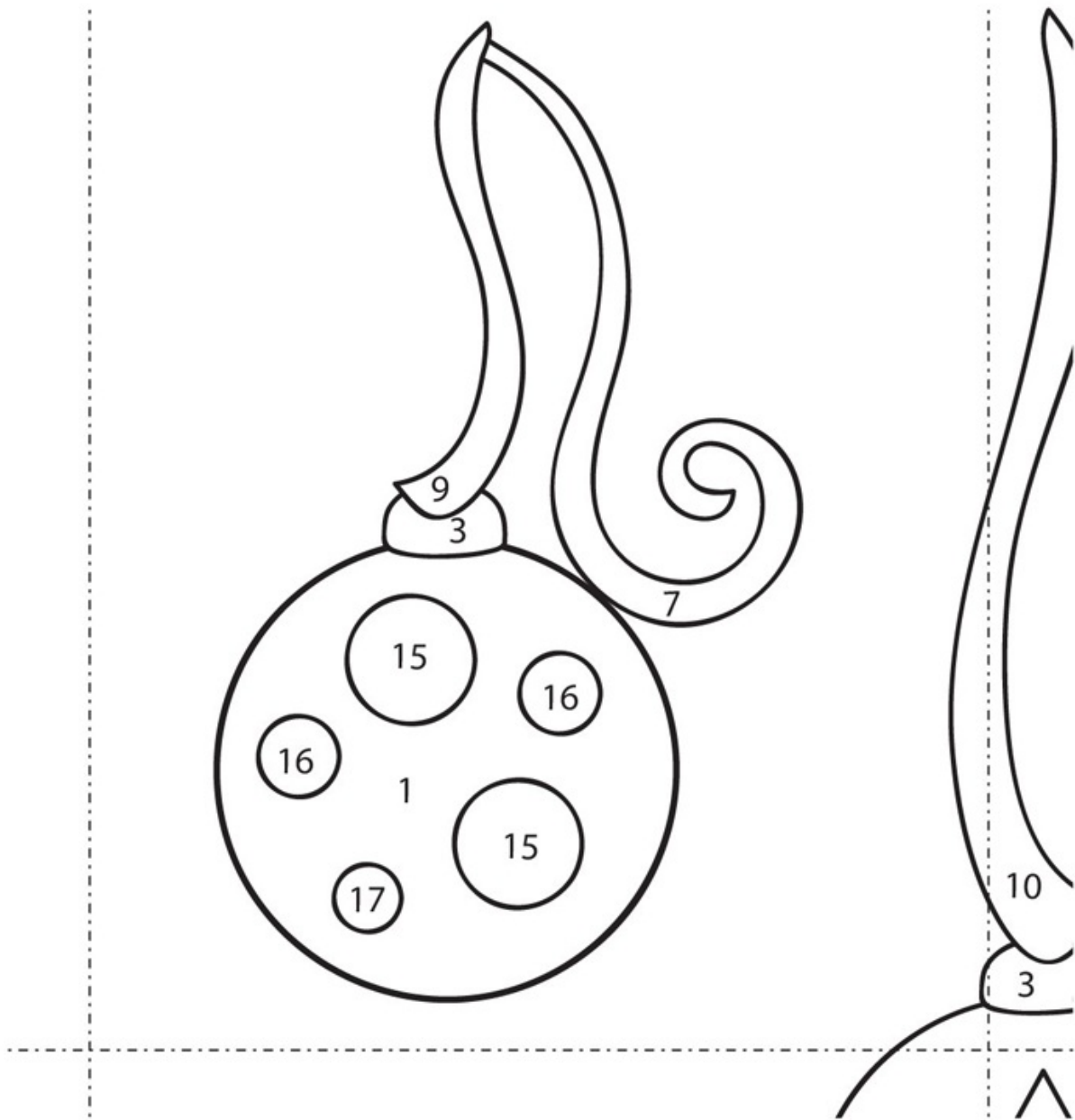
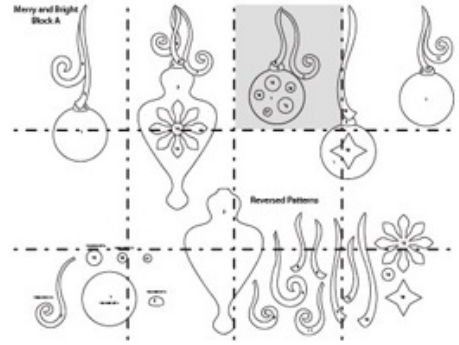
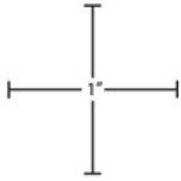

For all printable patterns or digital content: <http://tinyurl.com/11106-patterns-download>

# Merry and Bright: block A

Note: Patterns are also printed in reverse for fusible appliqué.

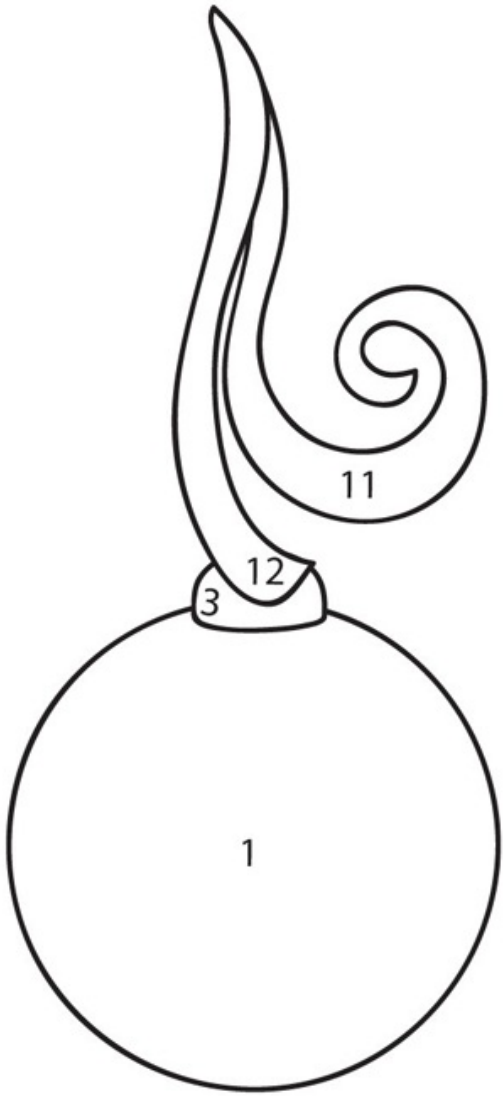
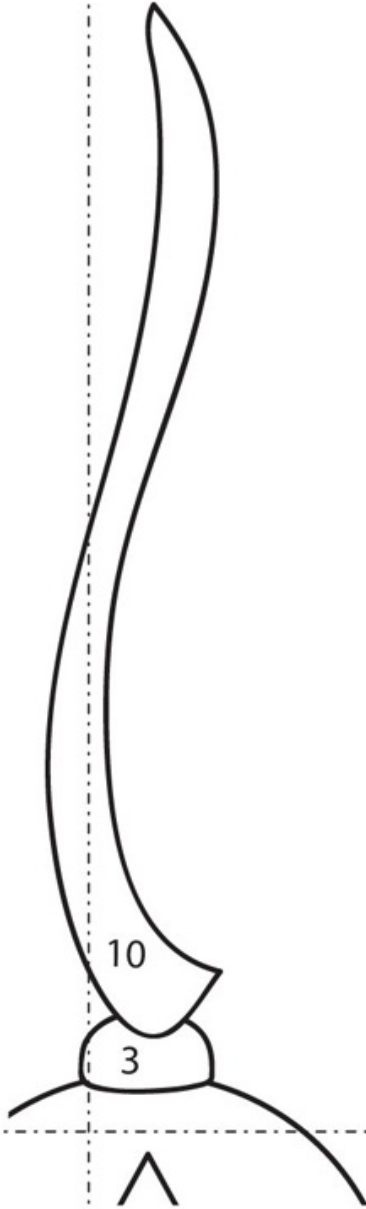
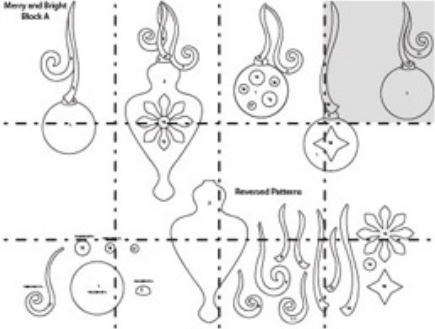
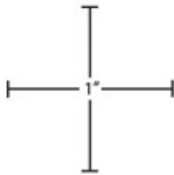

For all printable patterns or digital content: <http://tinyurl.com/11106-patterns-download>



# Merry and Bright: block A

Note: Patterns are also printed in reverse for fusible appliqué.

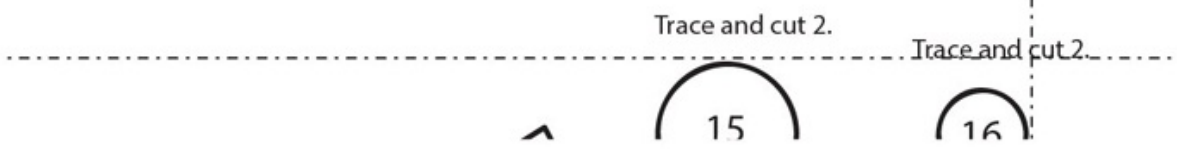
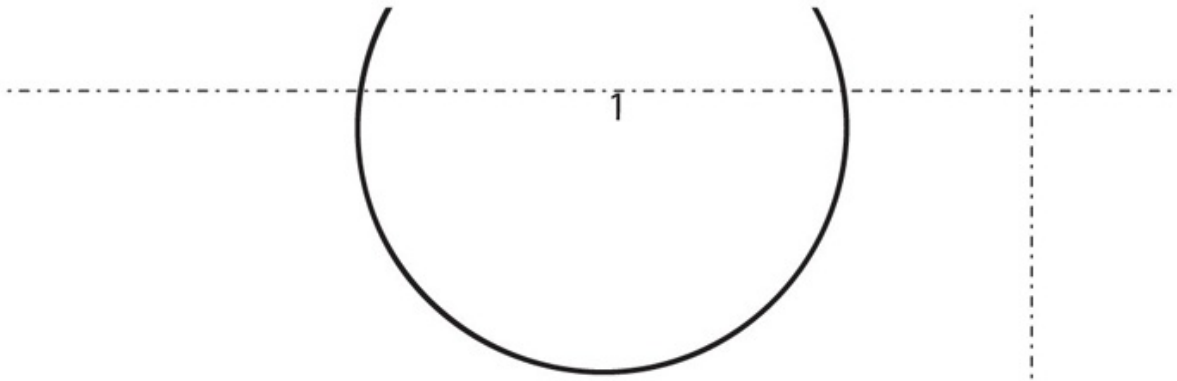
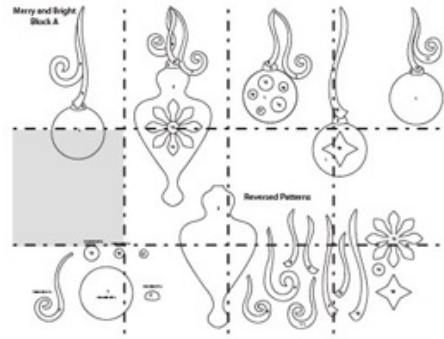
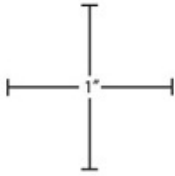

For all printable patterns or digital content: <http://tinyurl.com/11106-patterns-download>

# Merry and Bright: block A

Note: Patterns are also printed in reverse for fusible appliqué.

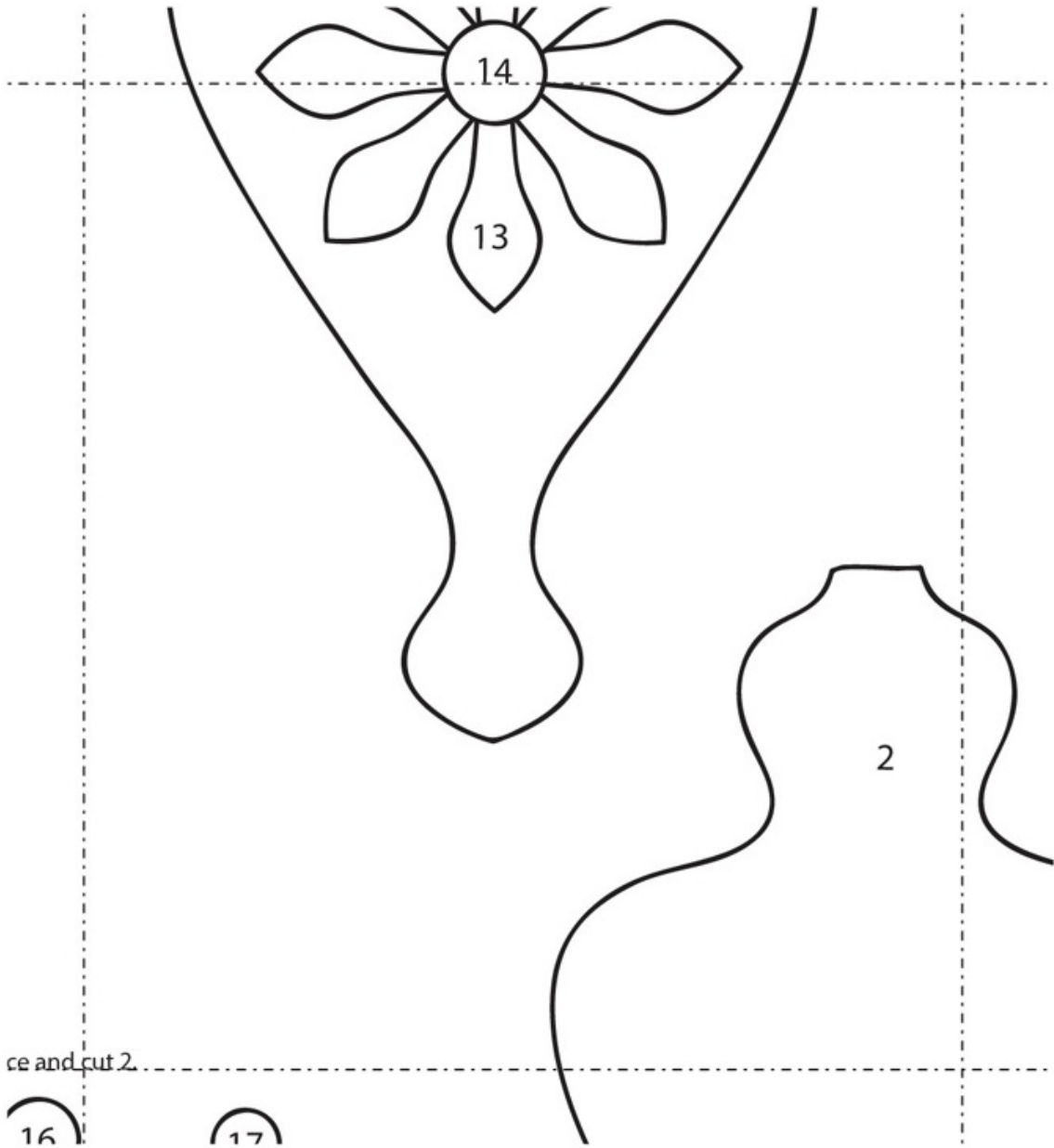
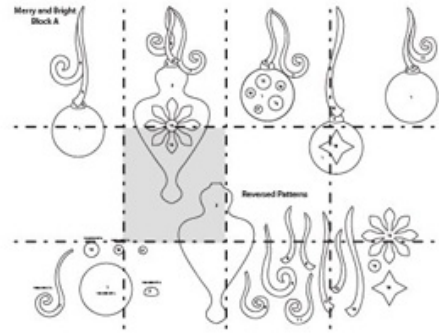
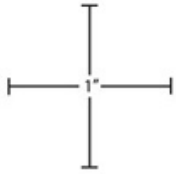

For all printable patterns or digital content: <http://tinyurl.com/11106-patterns-download>

# Merry and Bright: block A

Note: Patterns are also printed in reverse for fusible appliqué.

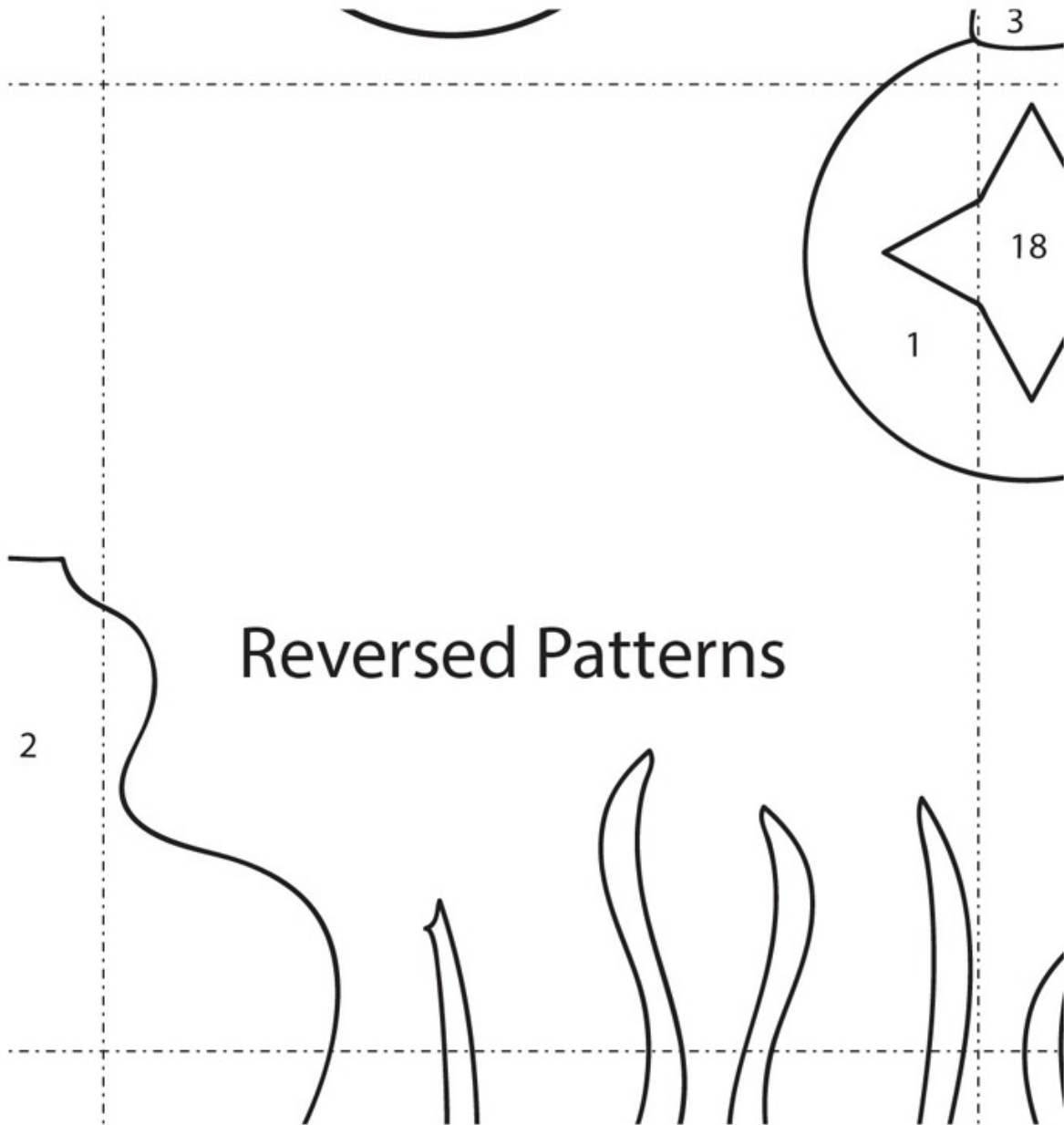
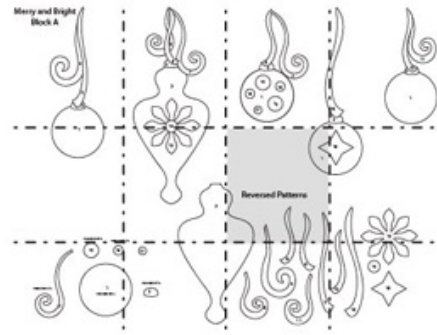
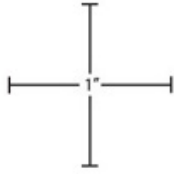

For all printable patterns or digital content: <http://tinyurl.com/11106-patterns-download>

# Merry and Bright: block A

Note: Patterns are also printed in reverse for fusible appliqué.

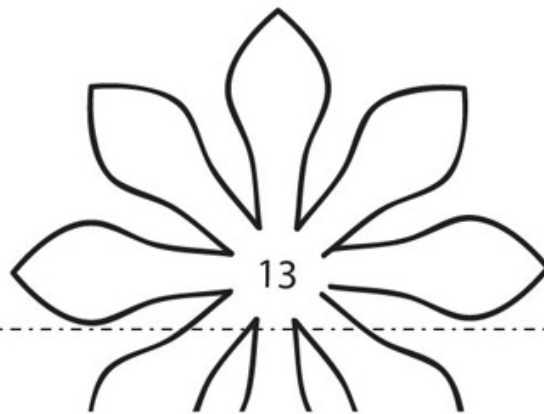
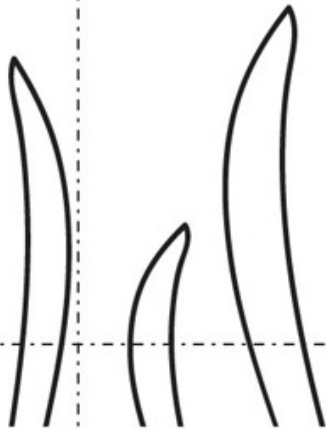
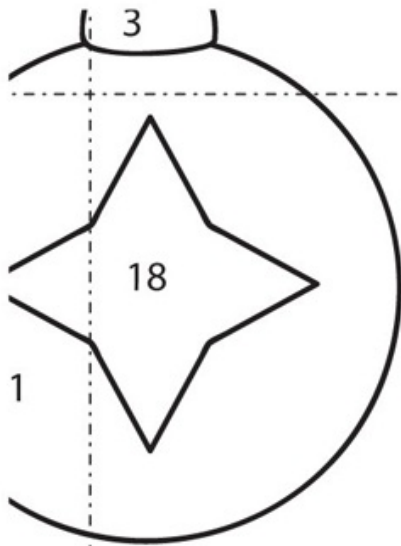
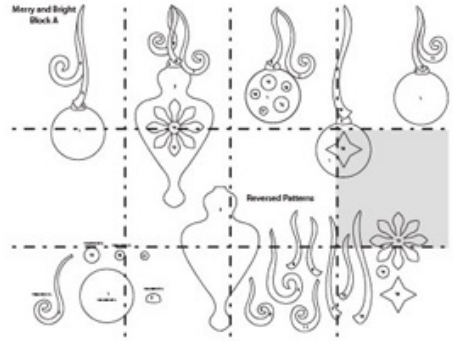
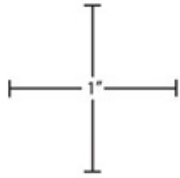

For all printable patterns or digital content: <http://tinyurl.com/11106-patterns-download>



# Merry and Bright: block A

Note: Patterns are also printed in reverse for fusible appliqué.

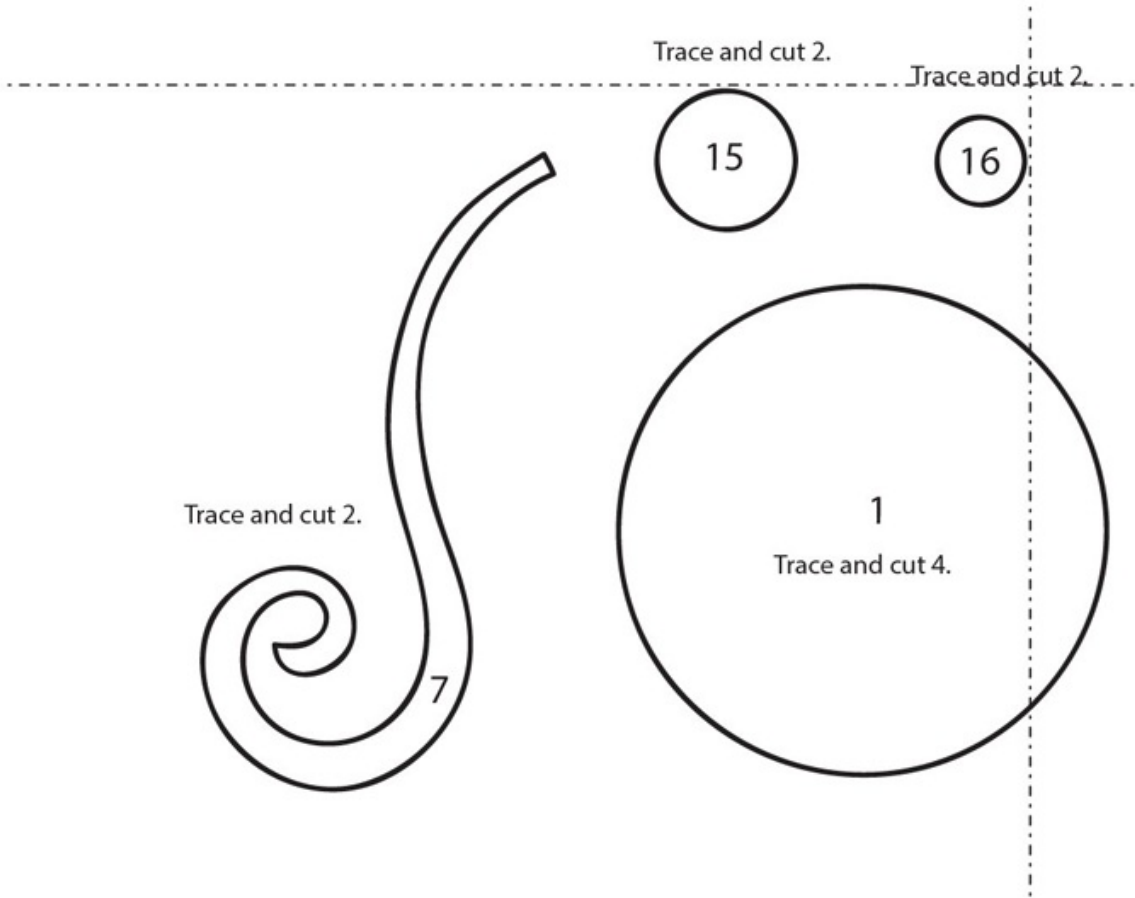
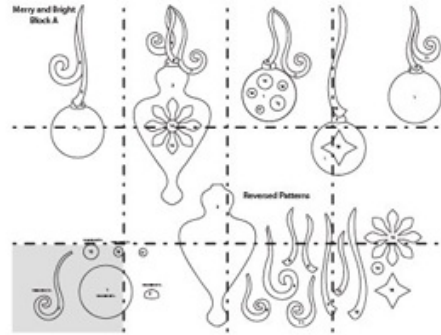
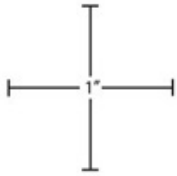

For all printable patterns or digital content: <http://tinyurl.com/11106-patterns-download>

# Merry and Bright: block A

Note: Patterns are also printed in reverse for fusible appliqué.

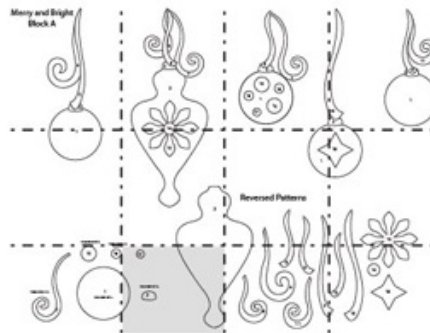
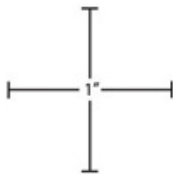

Trace and cut 2.

16

17

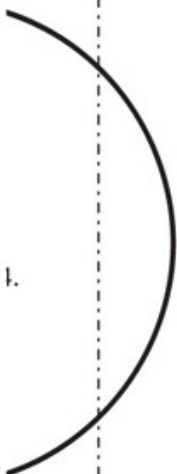

1.

Trace and cut 5.

3

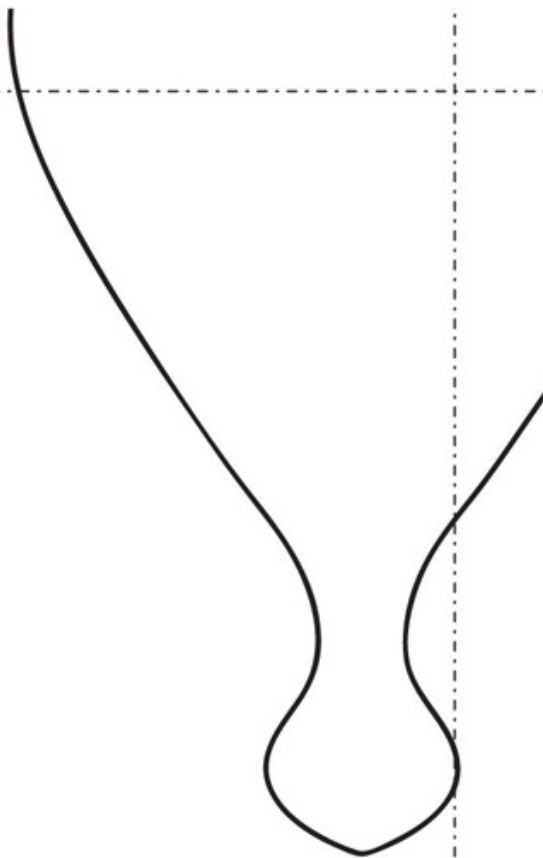

For all printable patterns or digital content: <http://tinyurl.com/11106-patterns-download>

# Merry and Bright: block A

Note: Patterns are also printed in reverse for fusible appliqué.

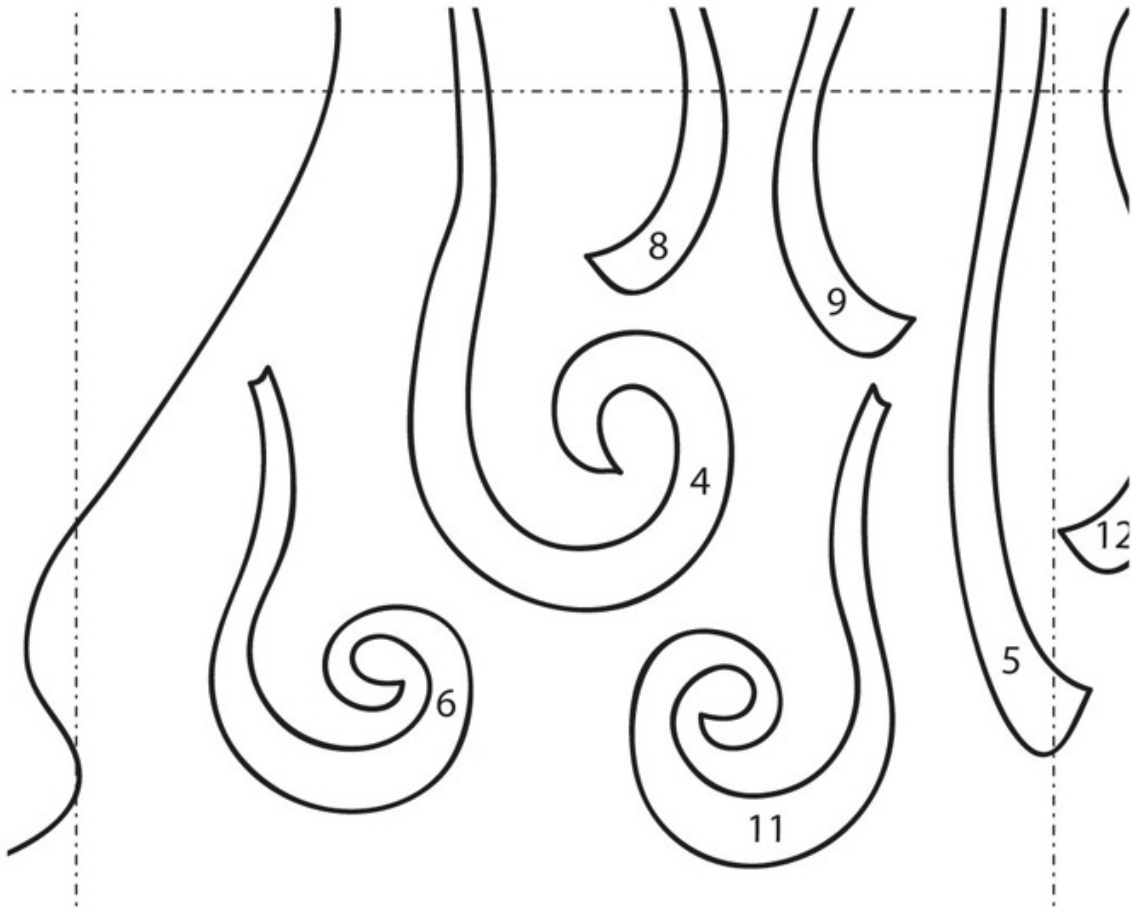
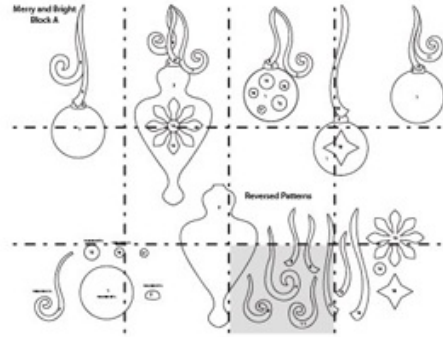
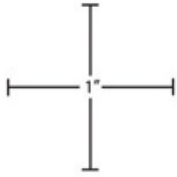

For all printable patterns or digital content: <http://tinyurl.com/11106-patterns-download>

### Merry and Bright: block A

*Note: Patterns are also printed in reverse for fusible appliqué.*

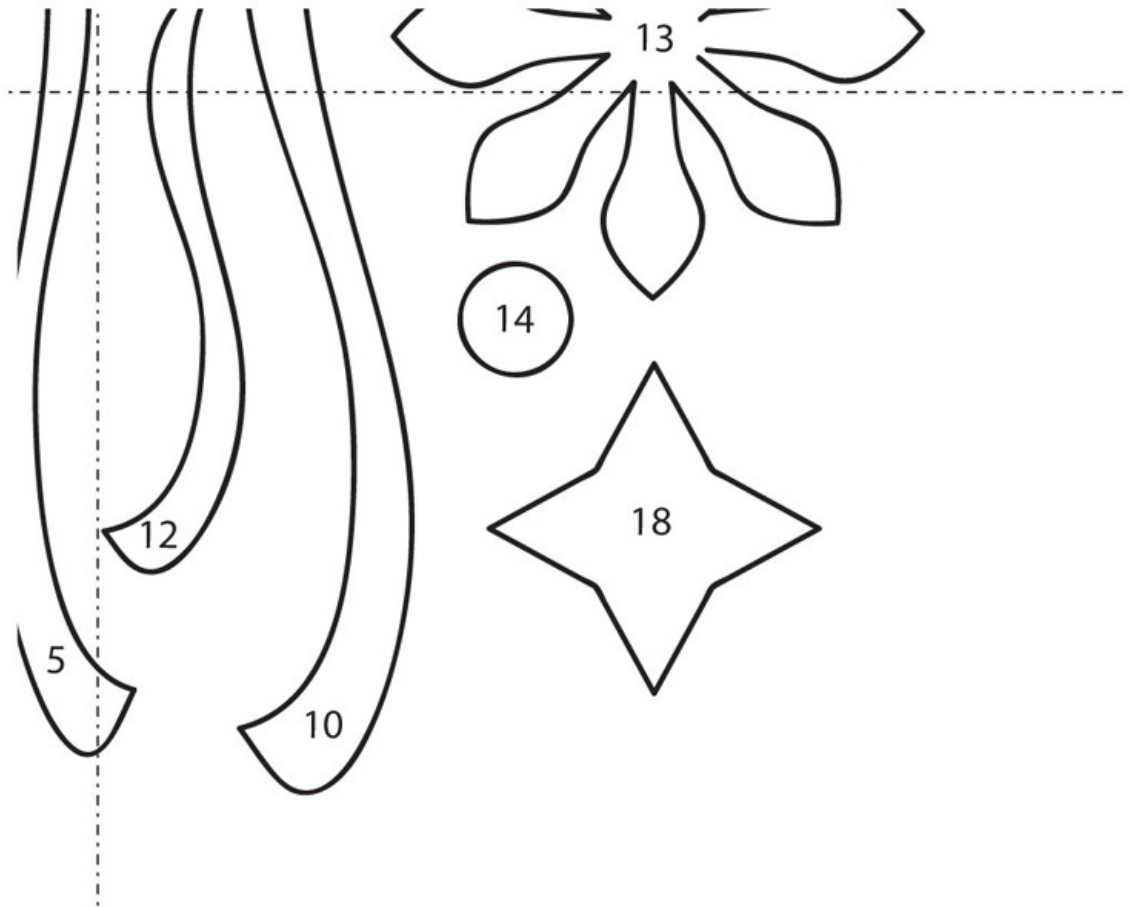
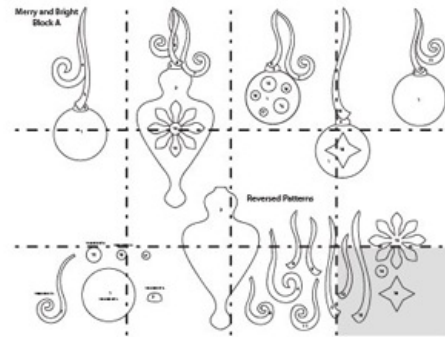
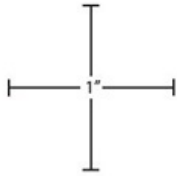

For all printable patterns or digital content: <http://tinyurl.com/11106-patterns-download>

## Merry and Bright: block B

Note: Patterns are also printed in reverse for fusible appliqué.

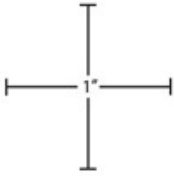

To make complete pattern, join the following pages, following the diagram for reference.

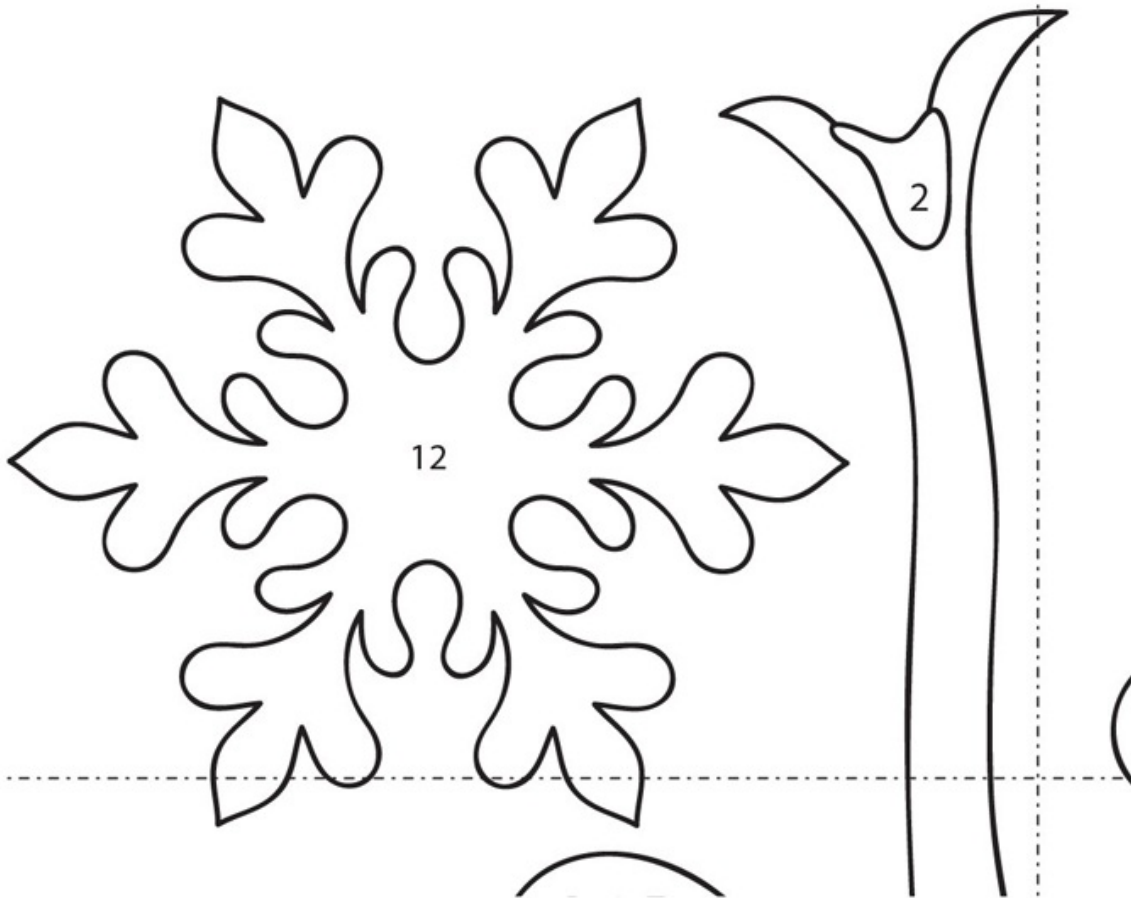
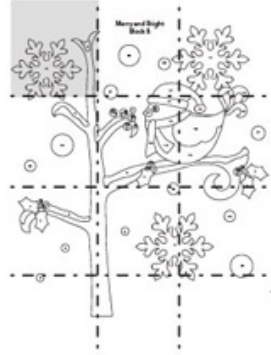

For all printable patterns or digital content: <http://tinyurl.com/11106-patterns-download>



## Merry and Bright: block B

Note: Patterns are also printed in reverse for fusible appliqué.

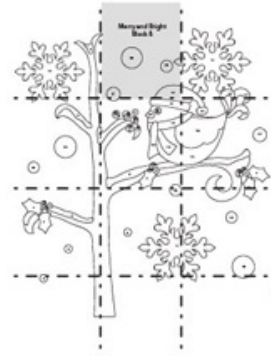
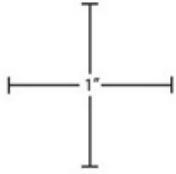

# Merry and Bright Block B

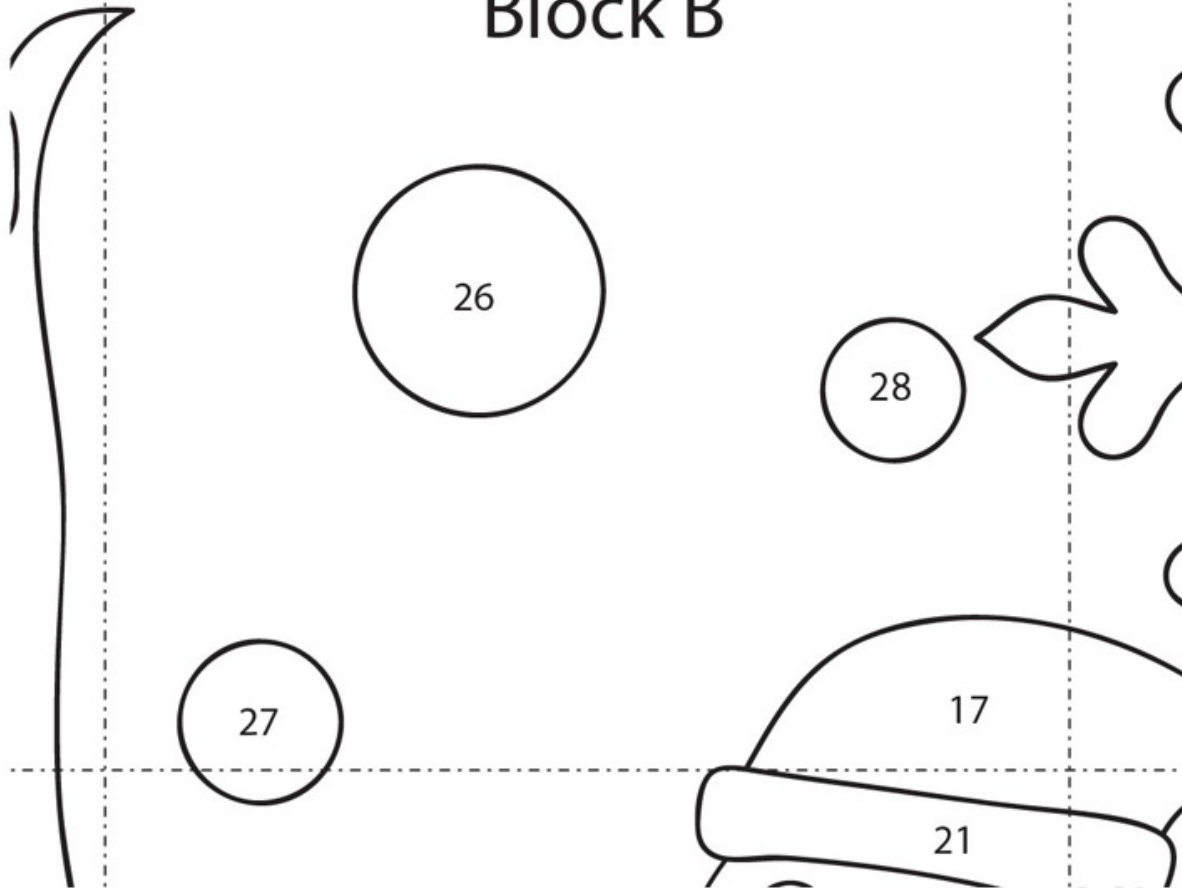

For all printable patterns or digital content: <http://tinyurl.com/11106->

### Merry and Bright: block B

Note: Patterns are also printed in reverse for fusible appliqué.

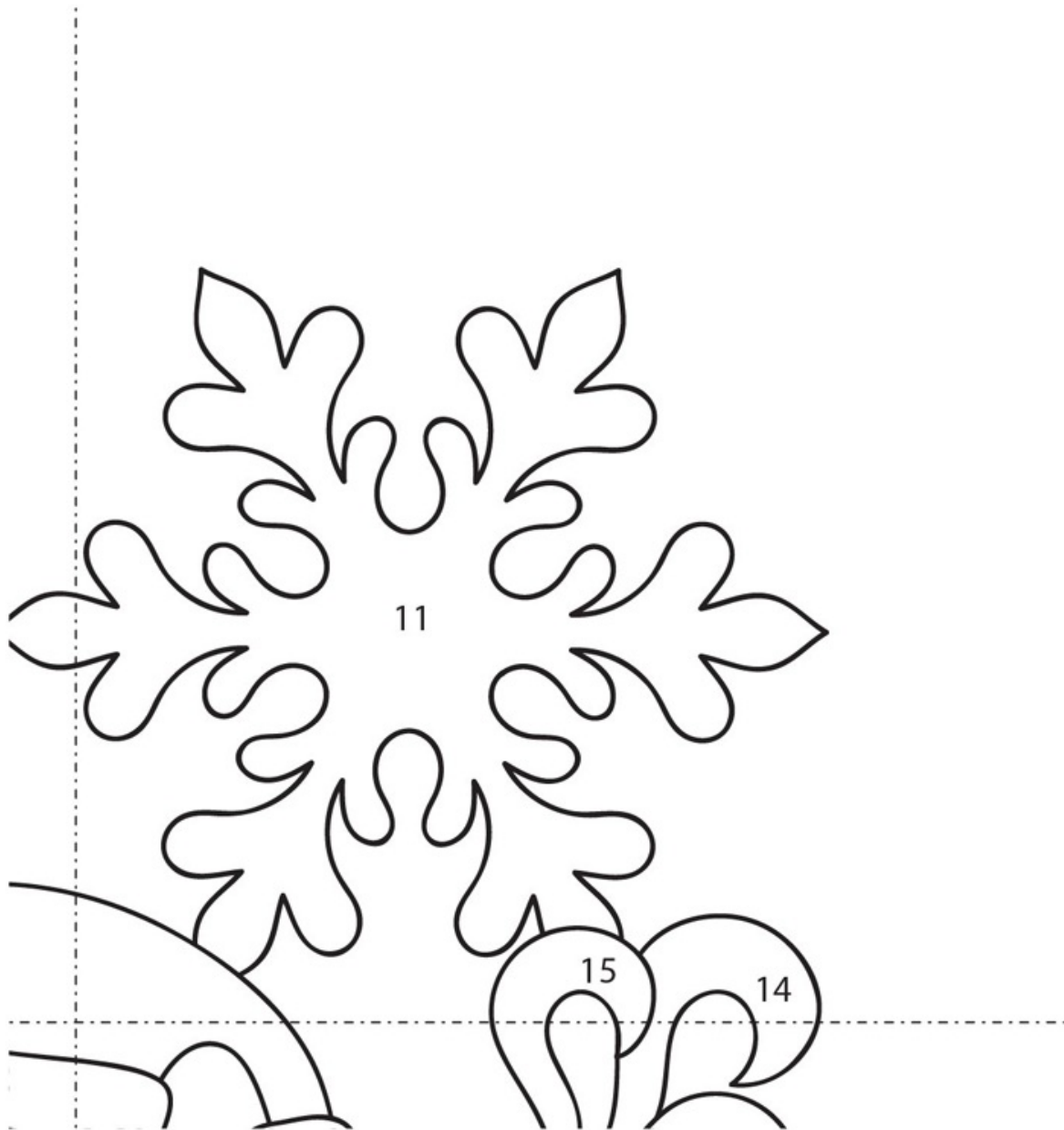
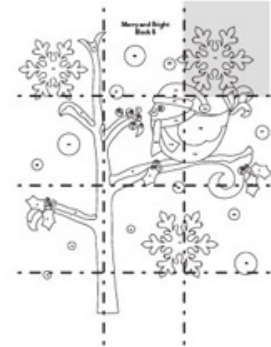
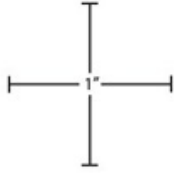

For all printable patterns or digital content: <http://tinyurl.com/11106-patterns-download>

# Merry and Bright: block B

Note: Patterns are also printed in reverse for fusible appliqué.

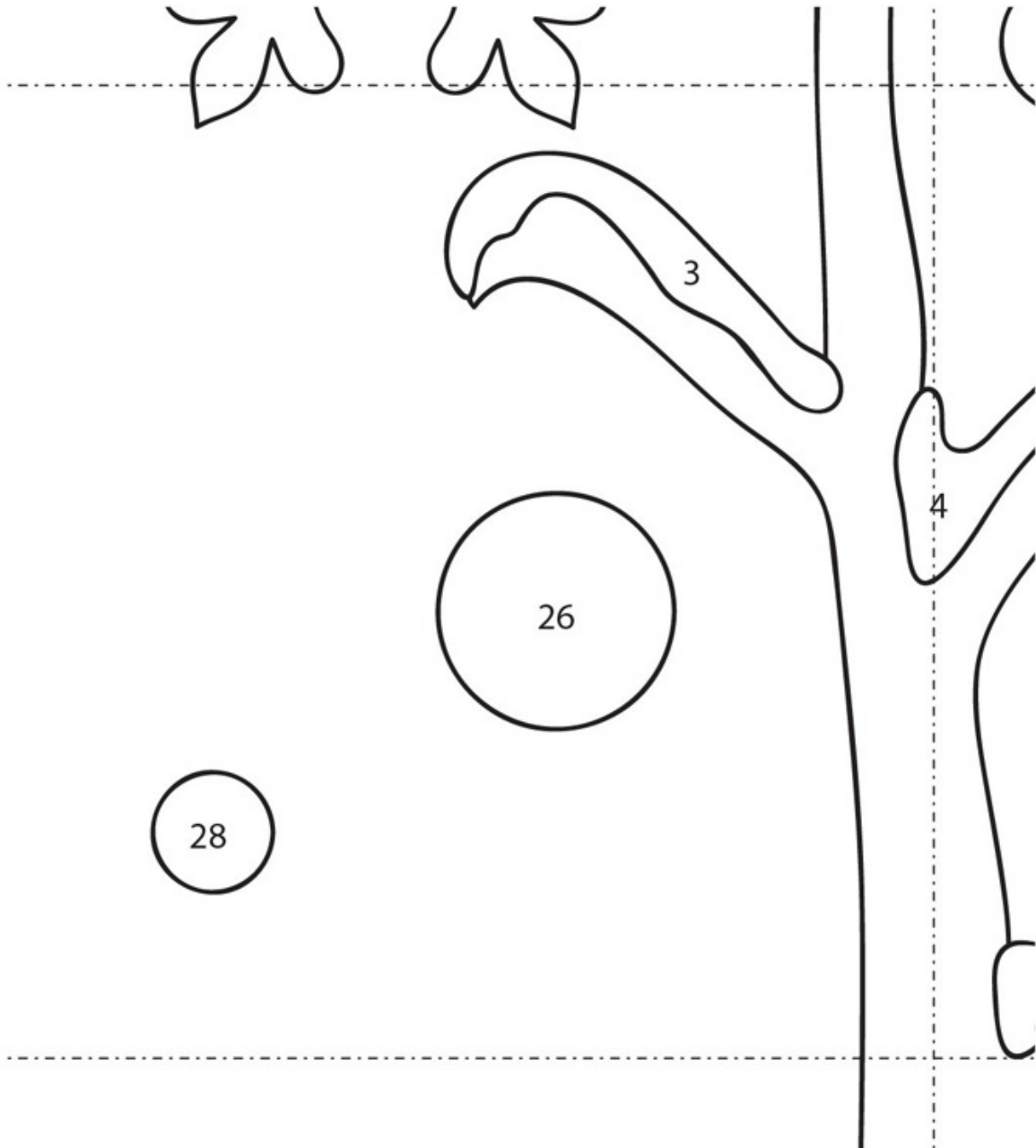
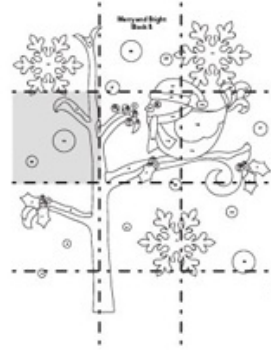
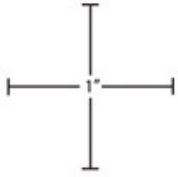

For all printable patterns or digital content: <http://tinyurl.com/11106-patterns-download>

# Merry and Bright: block B

Note: Patterns are also printed in reverse for fusible appliqué.

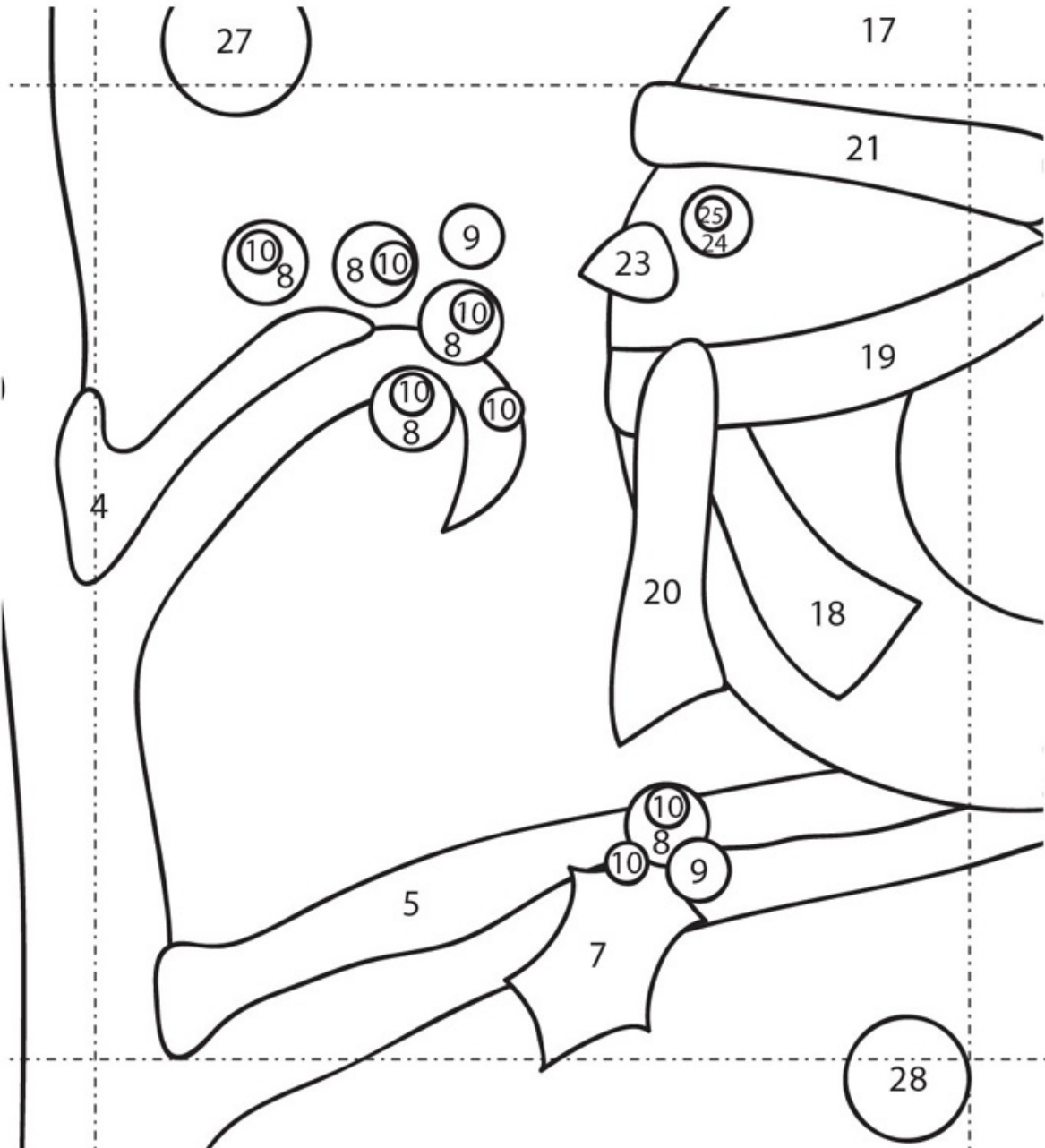
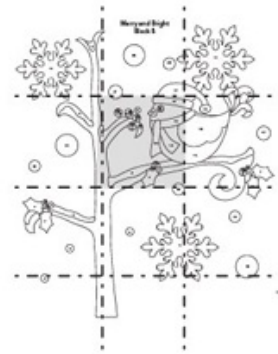
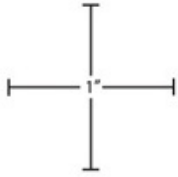

For all printable patterns or digital content: <http://tinyurl.com/11106-patterns-download>

# Merry and Bright: block B

Note: Patterns are also printed in reverse for fusible appliqué.

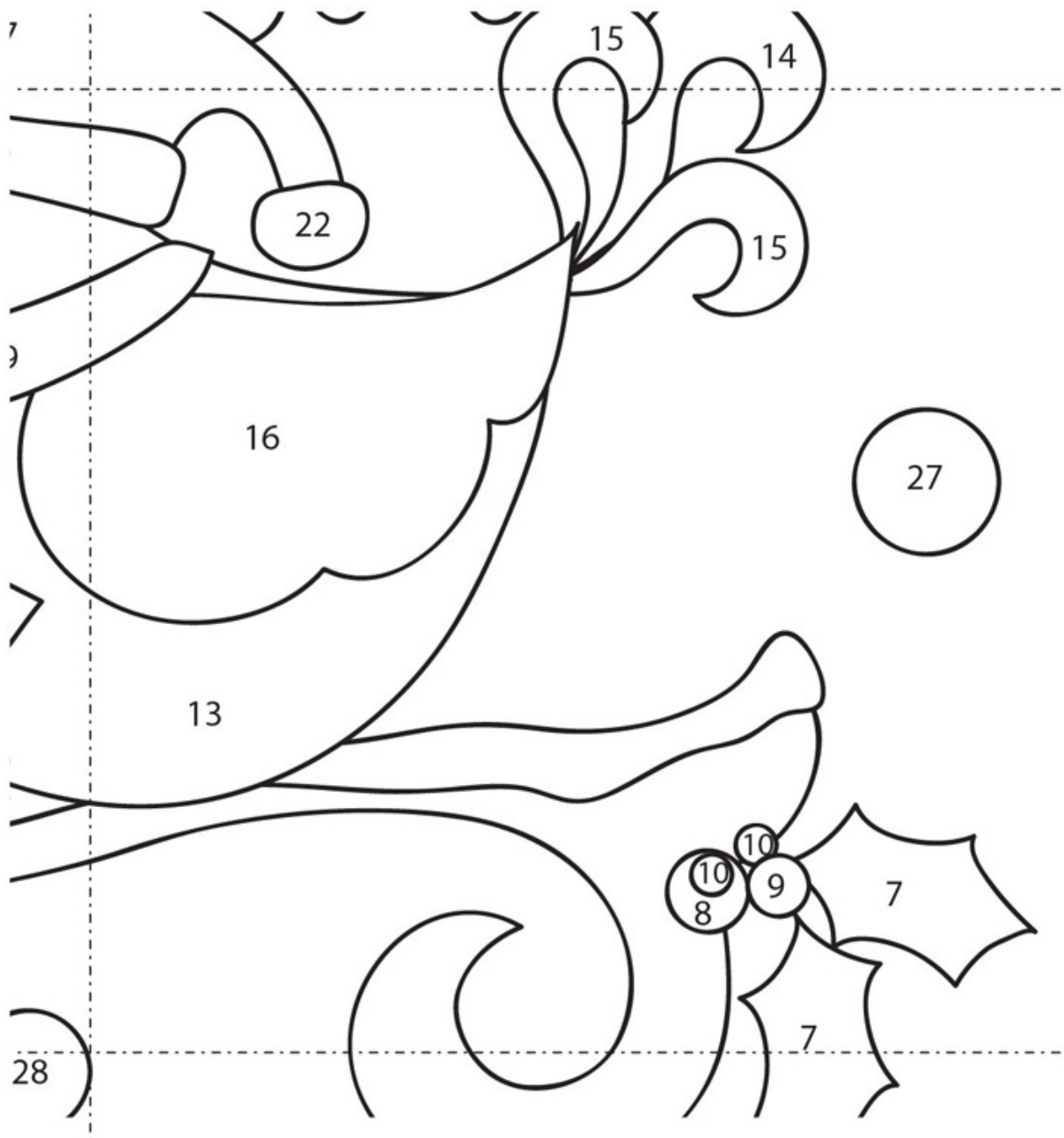
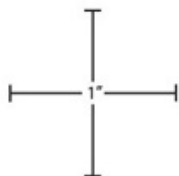



For all printable patterns or digital content: <http://tinyurl.com/11106-patterns-download>

# Merry and Bright: block B

Note: Patterns are also printed in reverse for fusible appliqué.

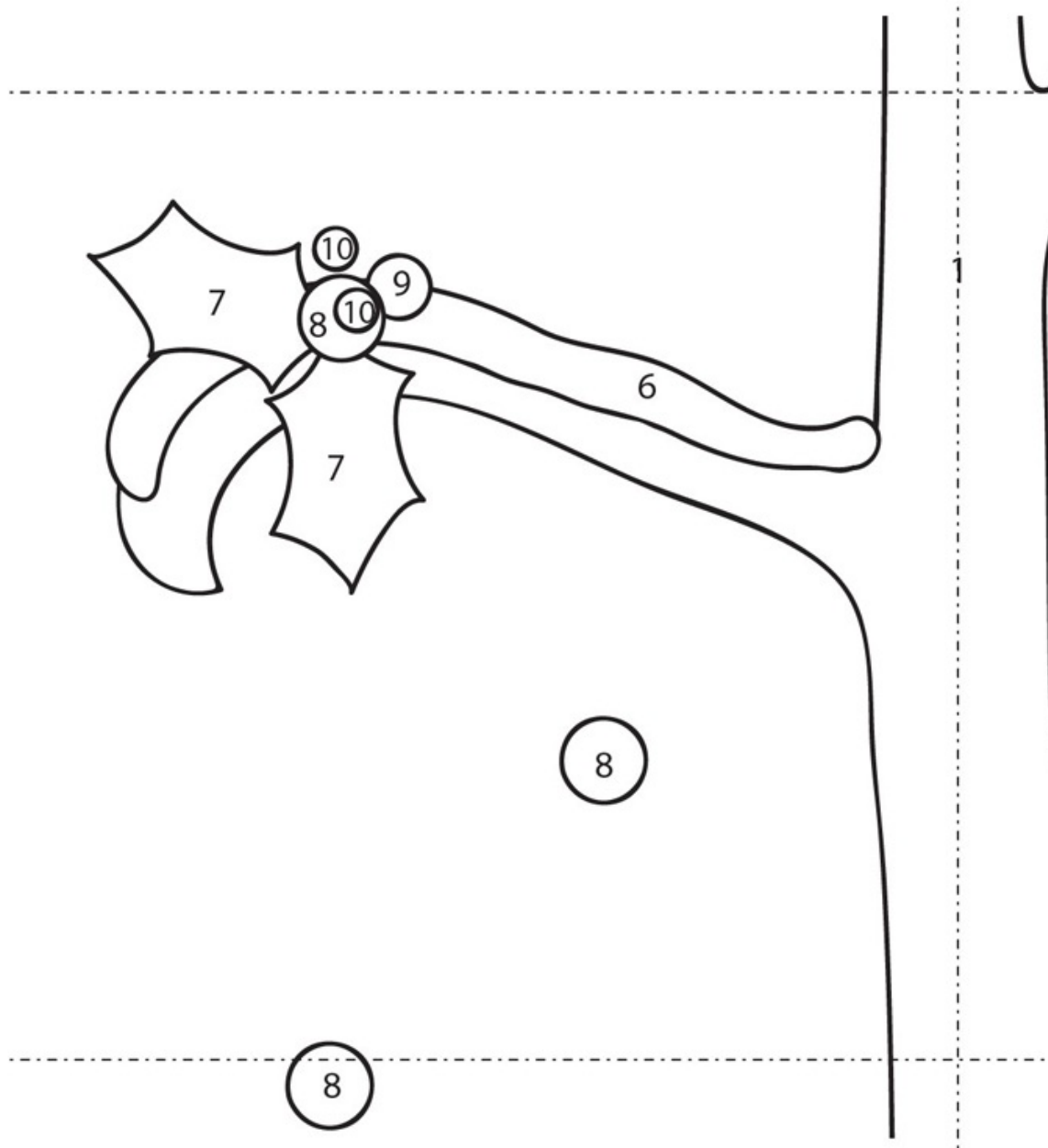
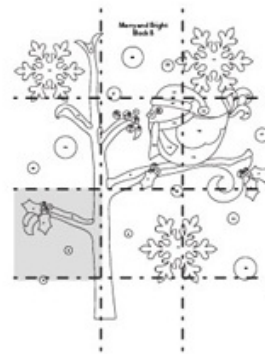
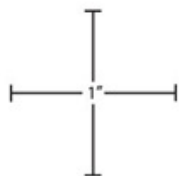

For all printable patterns or digital content: <http://tinyurl.com/11106-patterns-download>

**Merry and Bright: block B**

*Note: Patterns are also printed in reverse for fusible appliqué.*

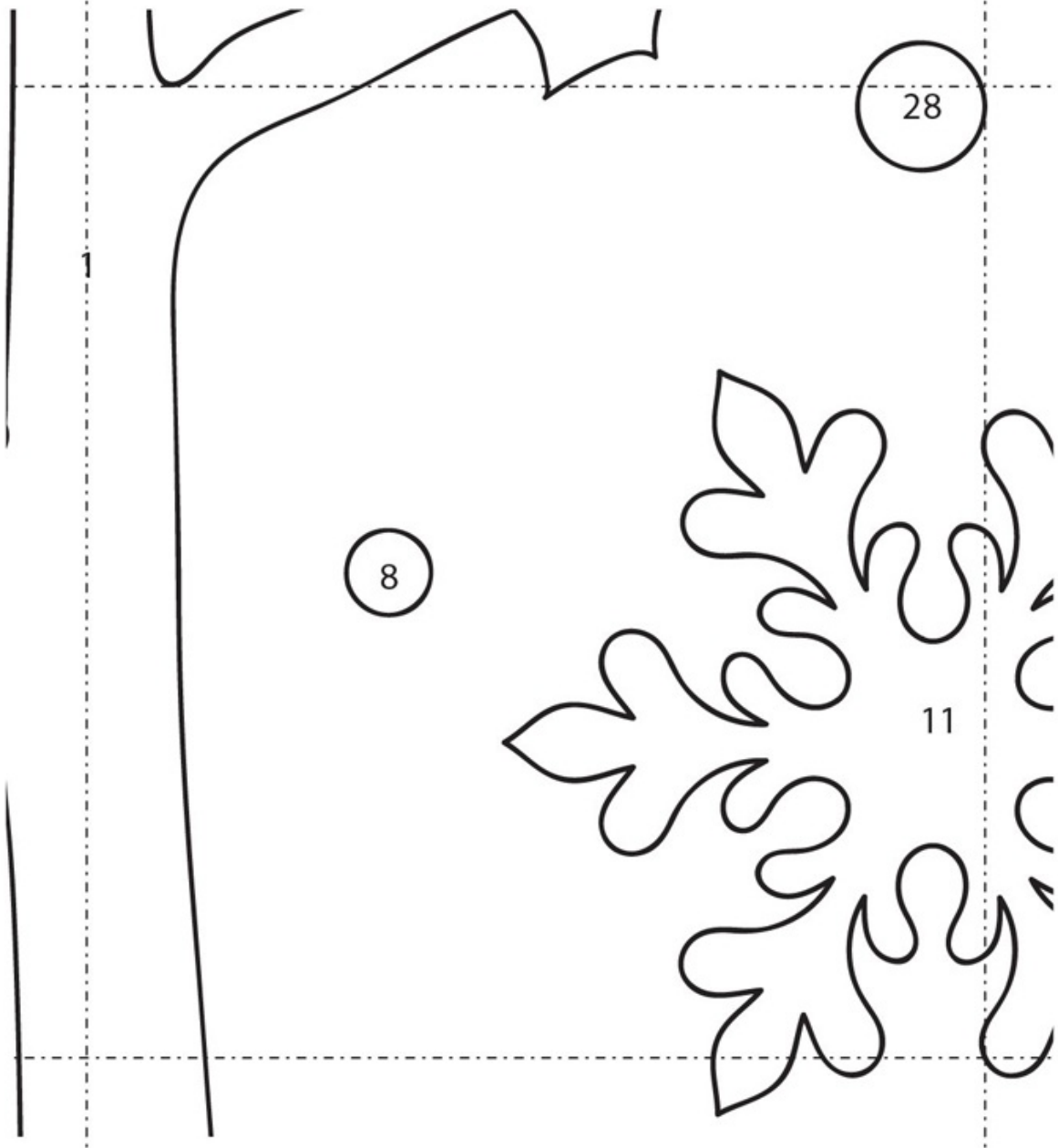
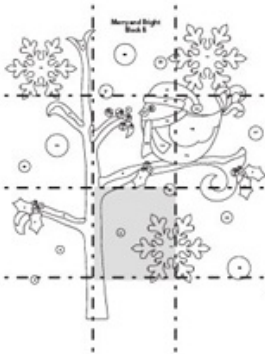
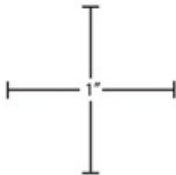

For all printable patterns or digital content: <http://tinyurl.com/11106-patterns-download>

## Merry and Bright: block B

Note: Patterns are also printed in reverse for fusible appliqué.

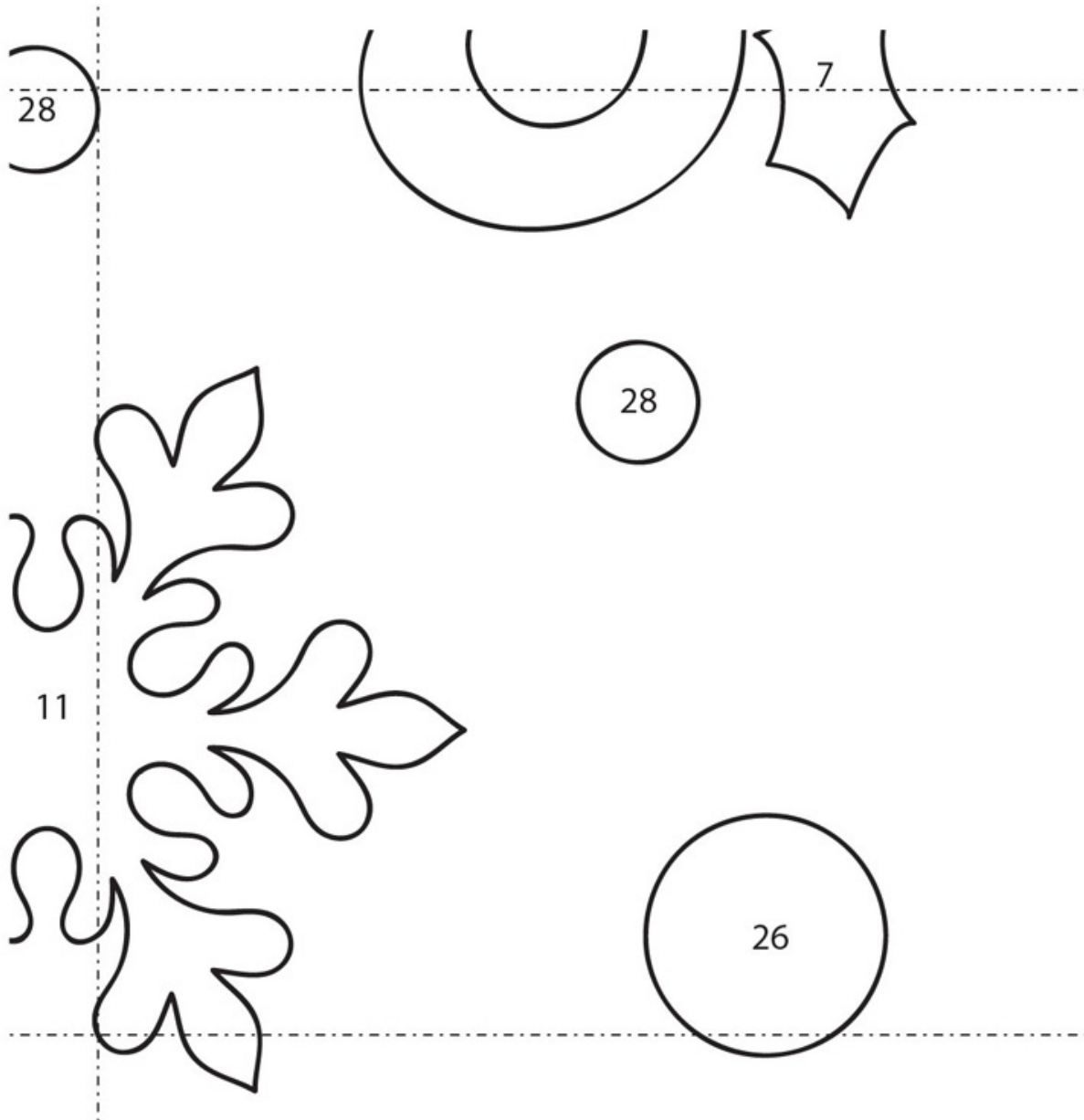
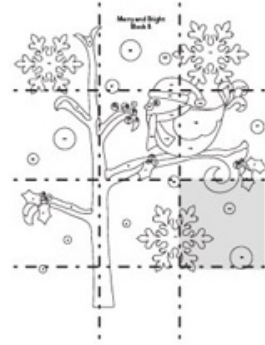
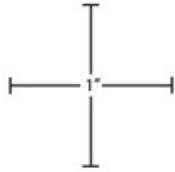

For all printable patterns or digital content: <http://tinyurl.com/11106->

patterns-download

**Merry and Bright: block B**

*Note: Patterns are also printed in reverse for fusible appliqué.*

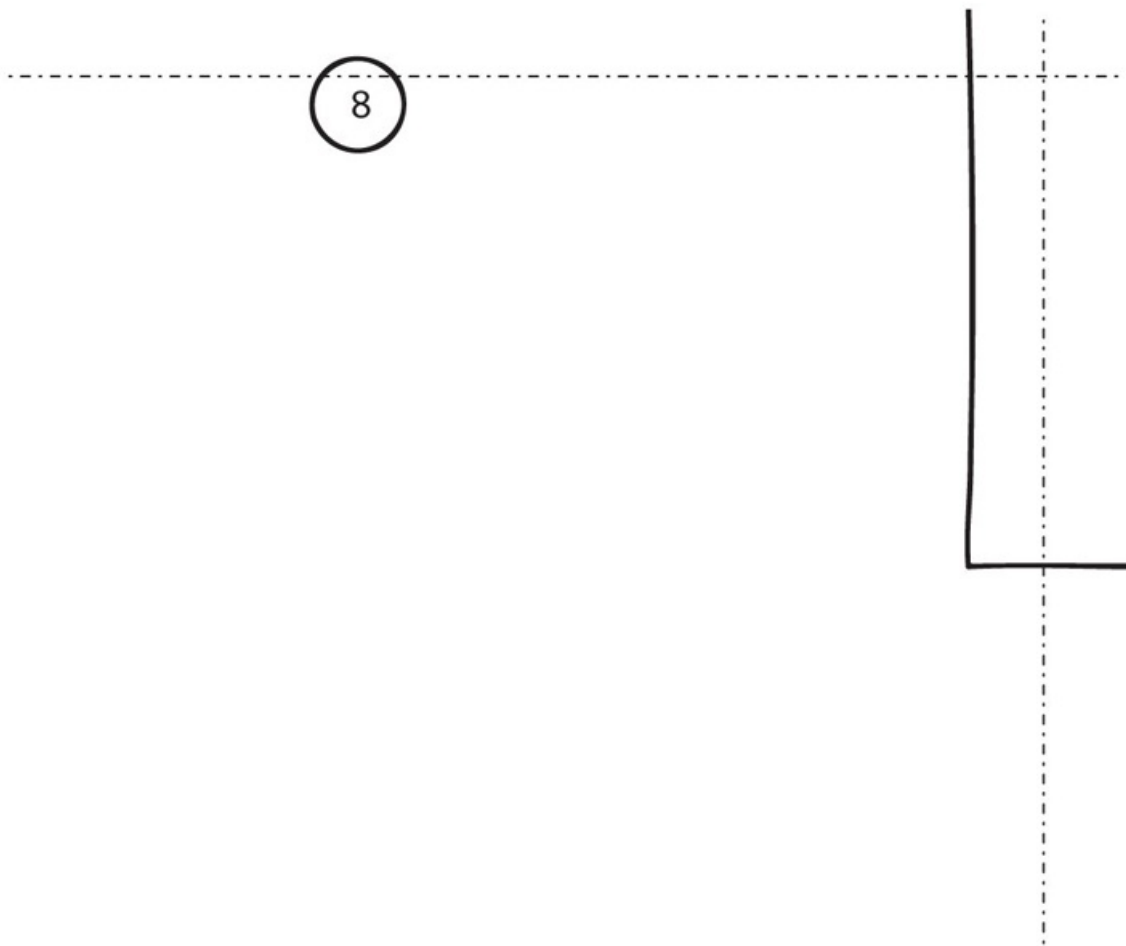
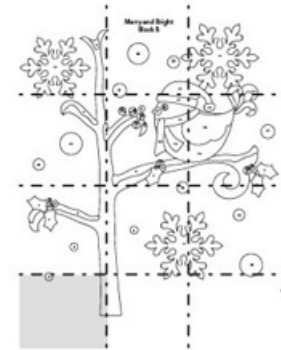
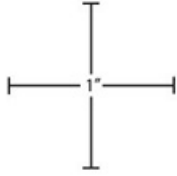

For all printable patterns or digital content: <http://tinyurl.com/11106->

[patterns-download](#)

### Merry and Bright: block B

*Note: Patterns are also printed in reverse for fusible appliqué.*

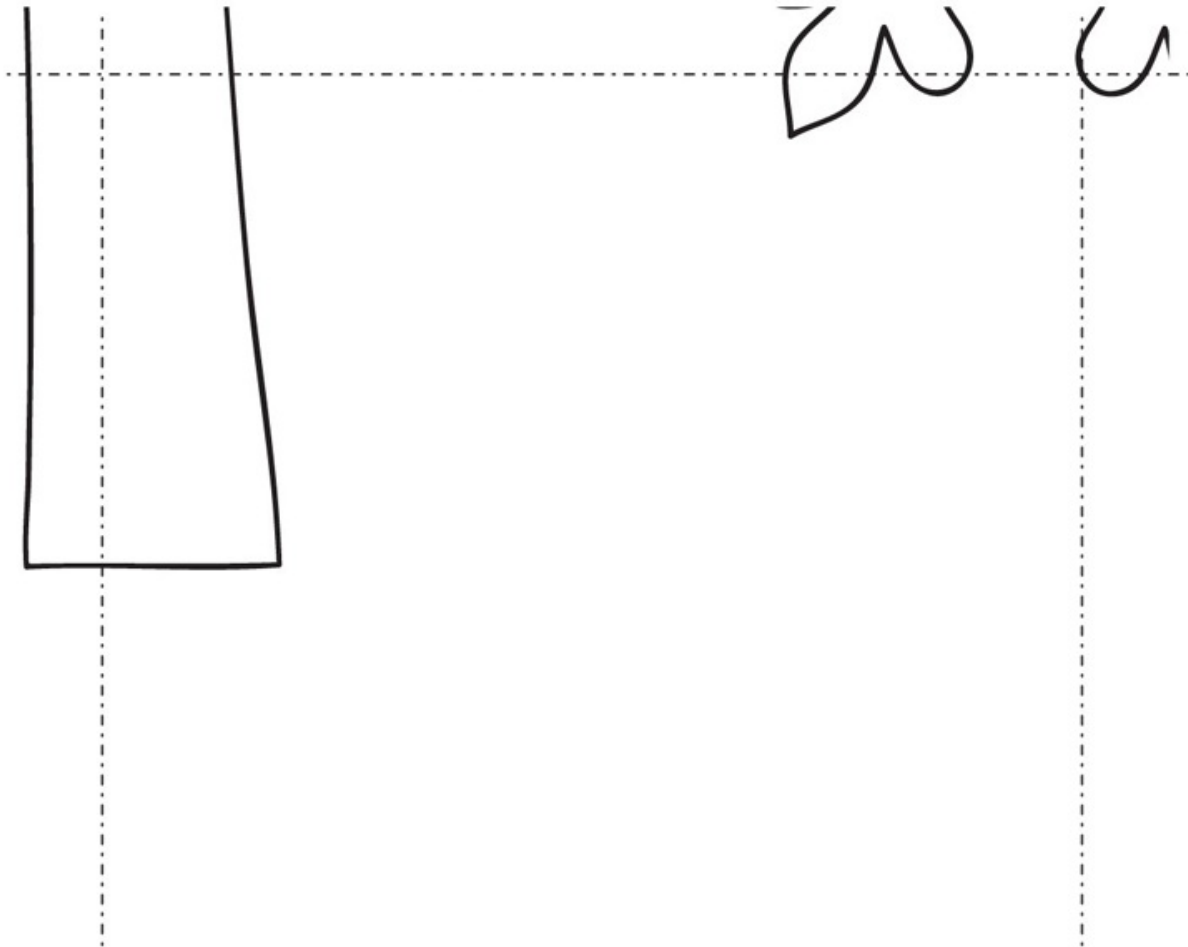
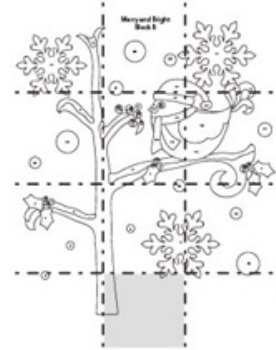
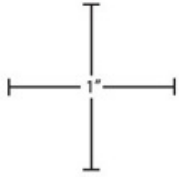



For all printable patterns or digital content: <http://tinyurl.com/11106-patterns-download>

## Merry and Bright: block B

*Note: Patterns are also printed in reverse for fusible appliqué.*

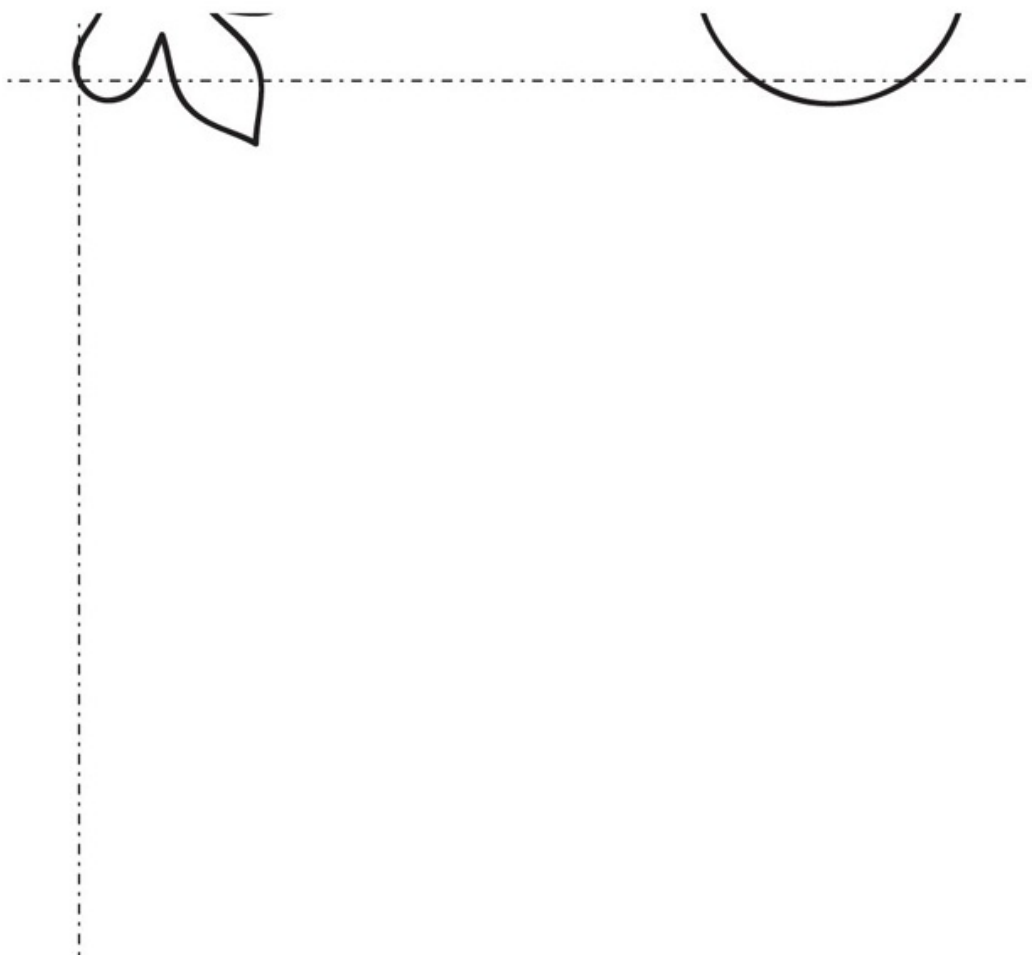
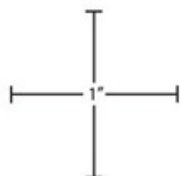

For all printable patterns or digital content: <http://tinyurl.com/11106-patterns-download>

## Merry and Bright: block B

Note: Patterns are also printed in reverse for fusible appliqué.

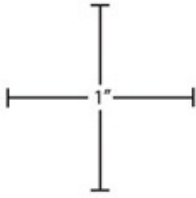

## Reversed Patterns

Trace and cut 4.



Trace and cut 11.



Trace and cut 5.



Trace and cut 2.



Trace and cut 4.



Trace and cut 3.

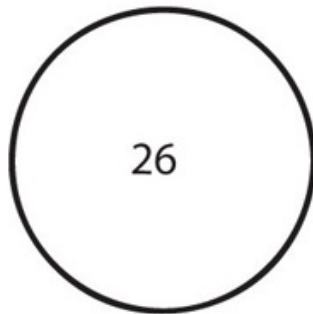

Trace and cut 10.



Trace and cut 2.



For all printable patterns or digital content: <http://tinyurl.com/11106-patterns-download>

## Merry and Bright: block B

*Note: Patterns are also printed in reverse for fusible appliqué.*

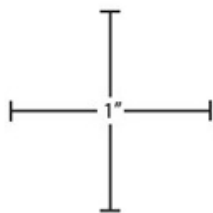

For all printable patterns or digital content: <http://tinyurl.com/11106->

patterns-download

## Merry and Bright: block B

*Note: Patterns are also printed in reverse for fusible appliqué.*

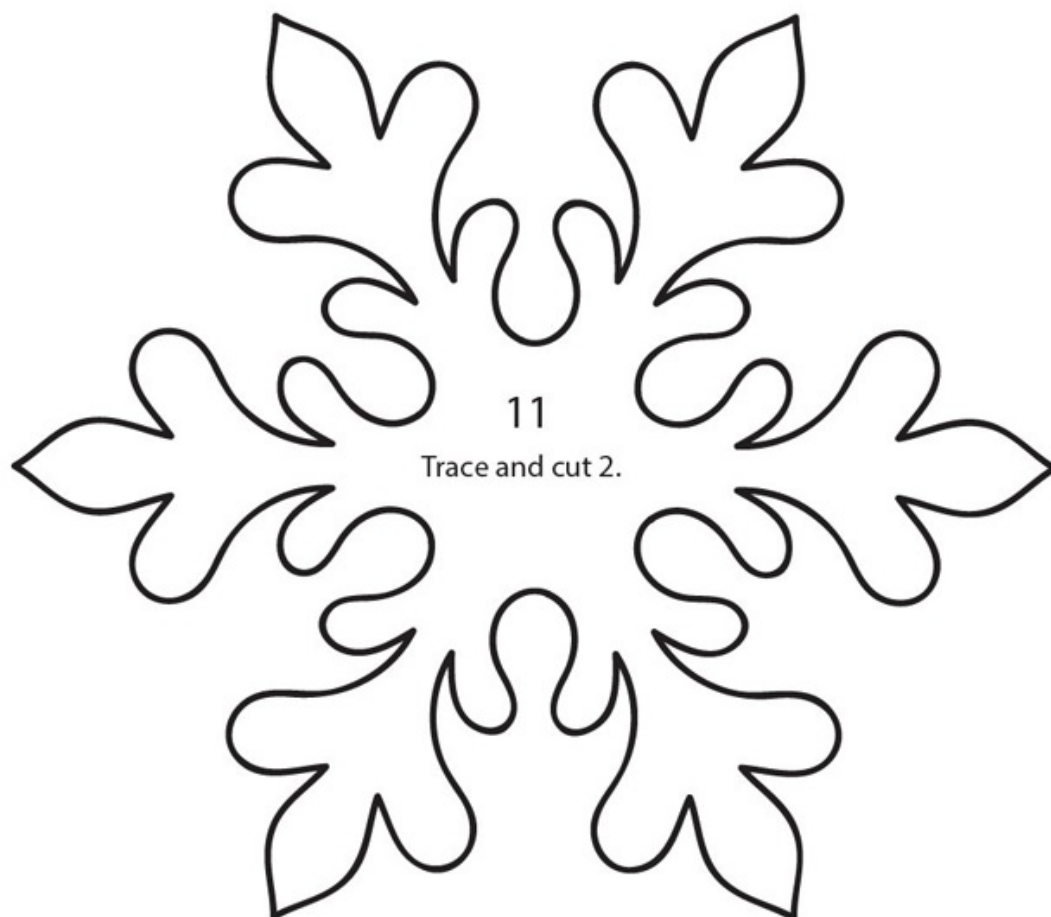
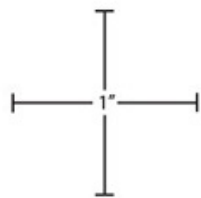

11

Trace and cut 2.



For all printable patterns or digital content: <http://tinyurl.com/11106-patterns-download>

**Merry and Bright: block B**

*Note: Patterns are also printed in reverse for fusible appliqué.*

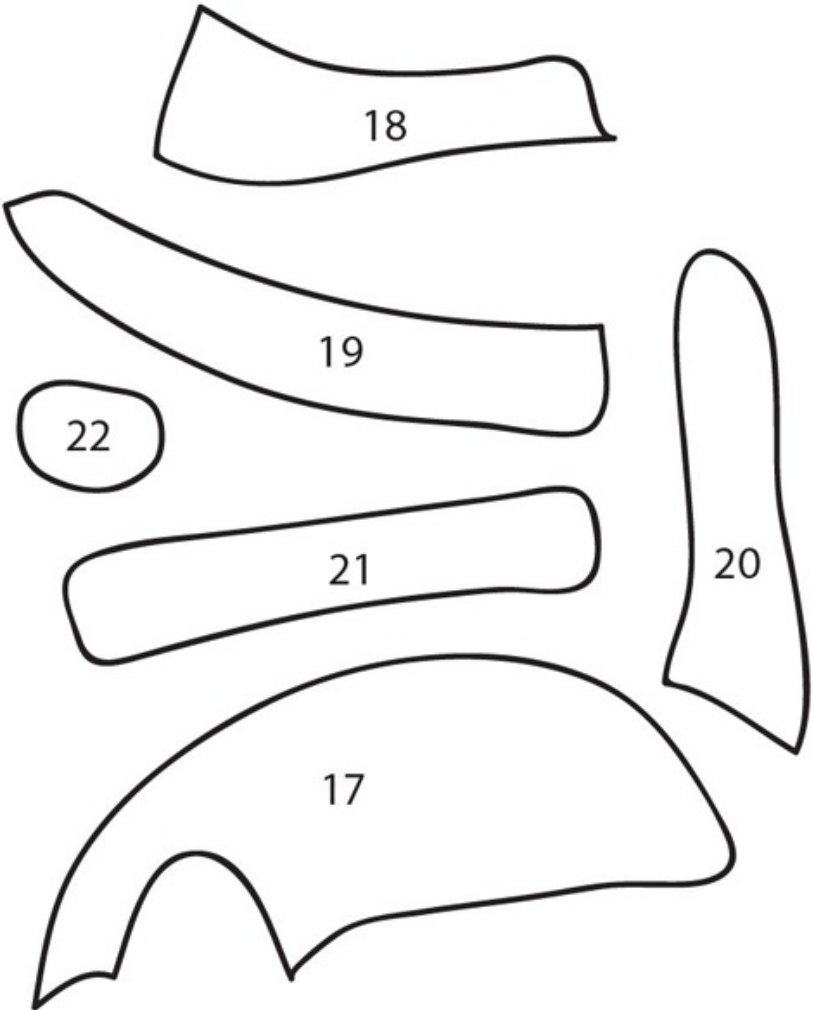
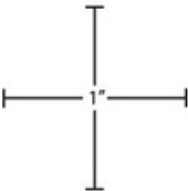

For all printable patterns or digital content: <http://tinyurl.com/11106-patterns-download>

## Merry and Bright: block B

*Note: Patterns are also printed in reverse for fusible appliqué.*

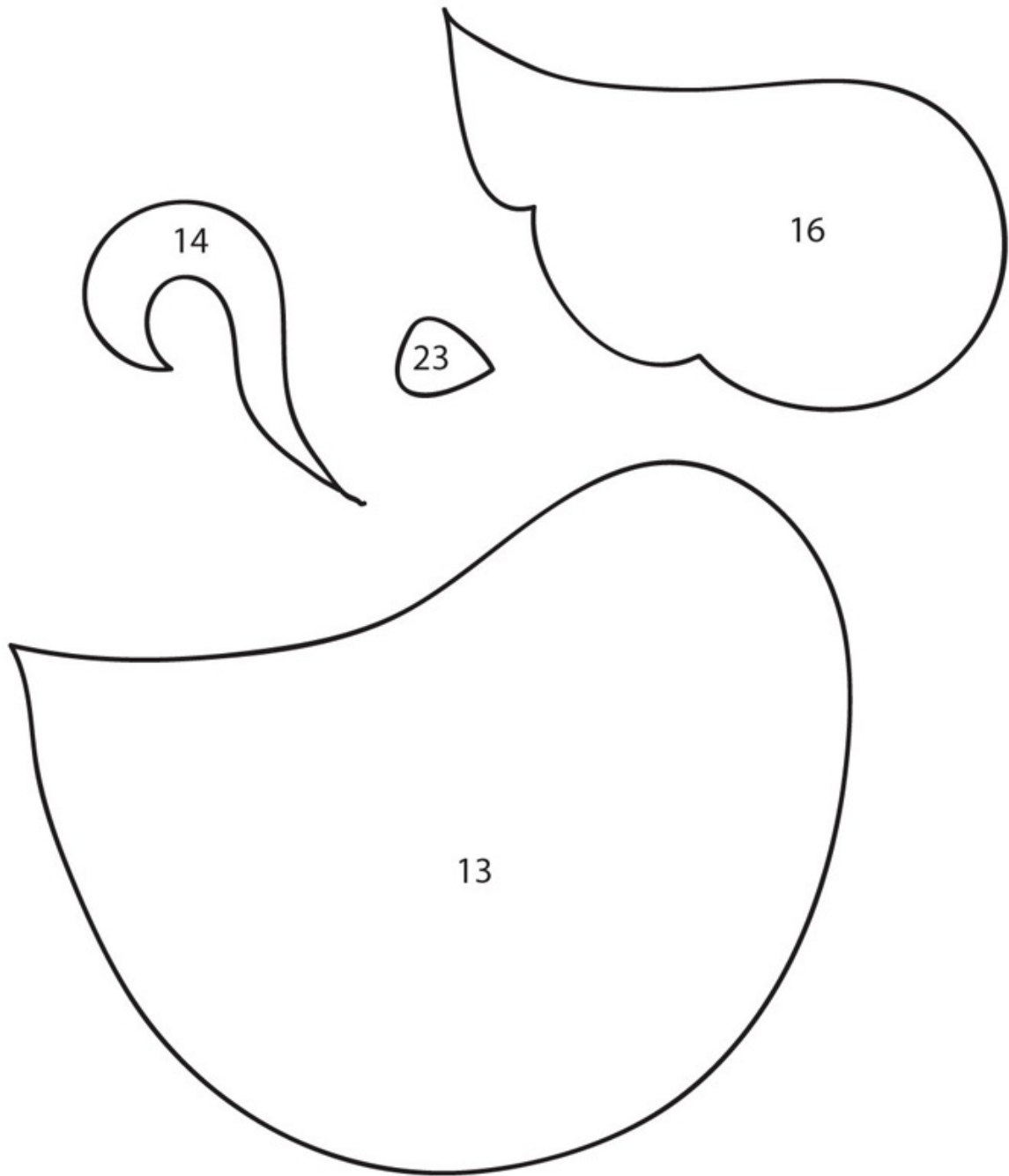
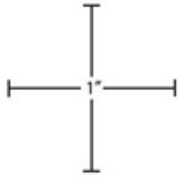

For all printable patterns or digital content: <http://tinyurl.com/11106-patterns-download>

## Merry and Bright: block B

Note: Patterns are also printed in reverse for fusible appliqué.

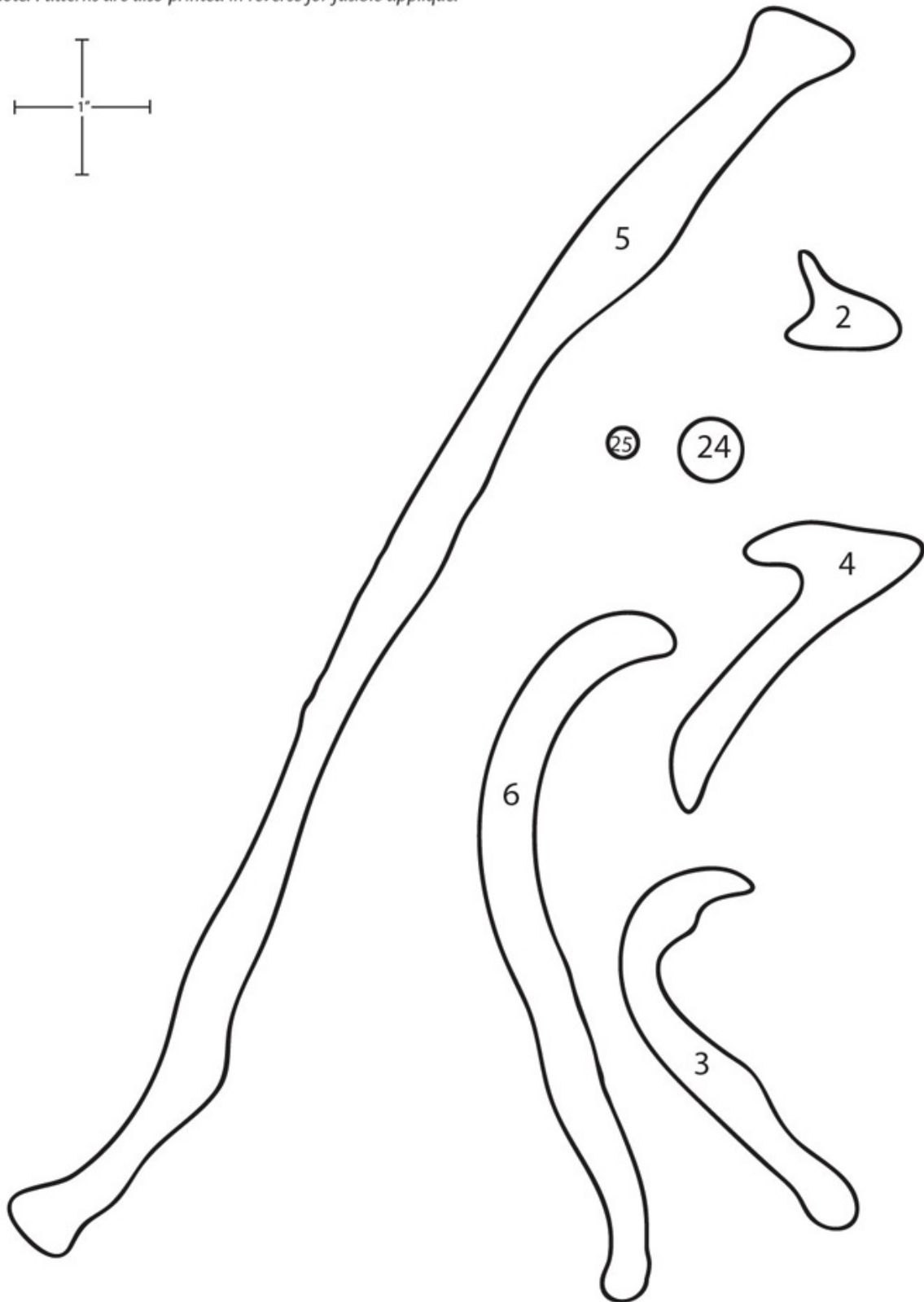
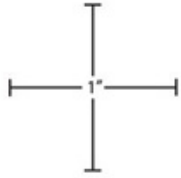

For all printable patterns or digital content: <http://tinyurl.com/11106-patterns-download>

## Merry and Bright: block B

*Note: Patterns are also printed in reverse for fusible appliqué.*

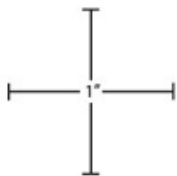

To make complete pattern, join the following pages, following the diagram for reference.

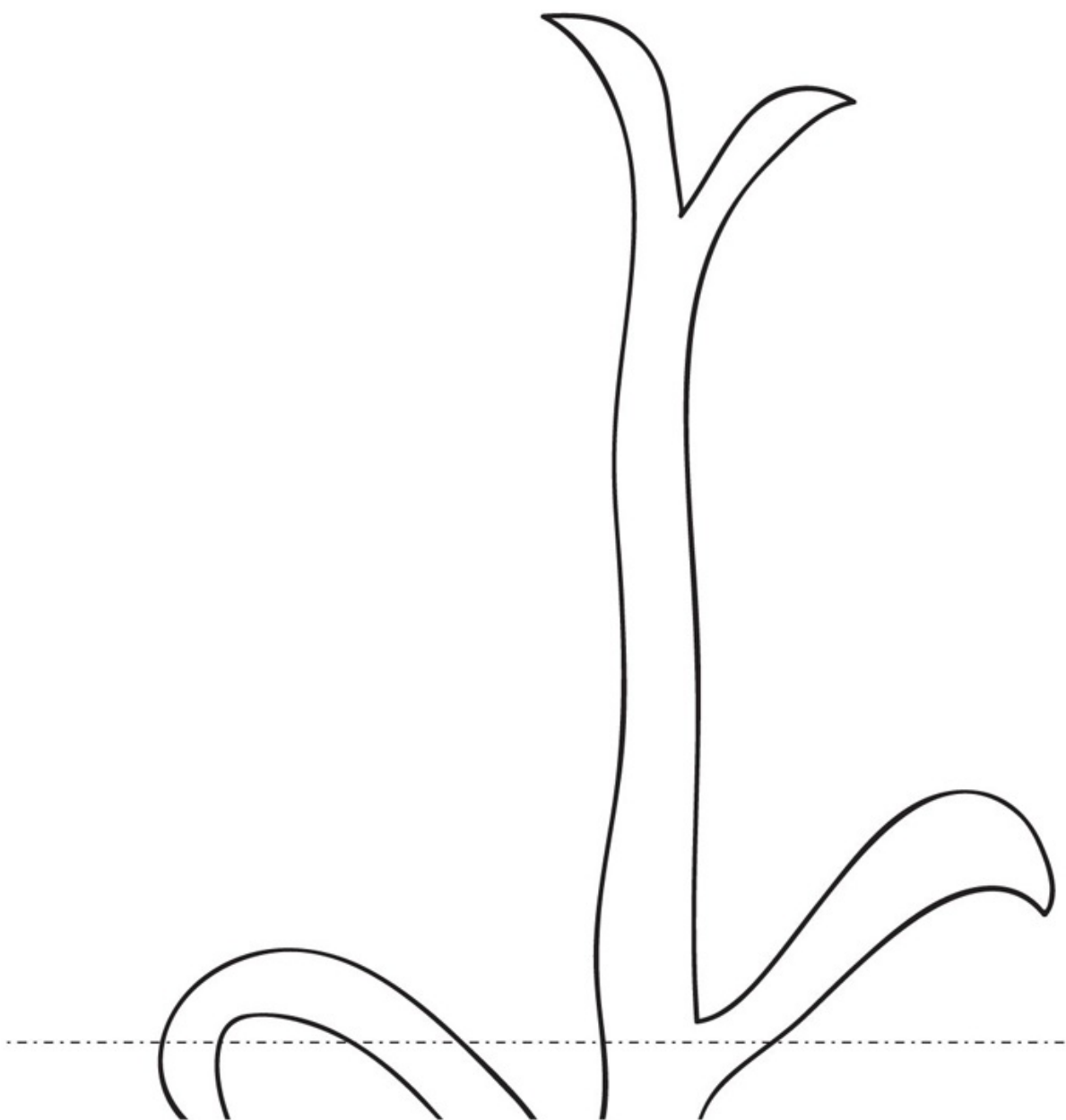
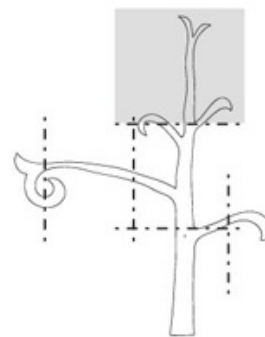



For all printable patterns or digital content: <http://tinyurl.com/11106-patterns-download>

## Merry and Bright: block B

*Note: Patterns are also printed in reverse for fusible appliqué.*

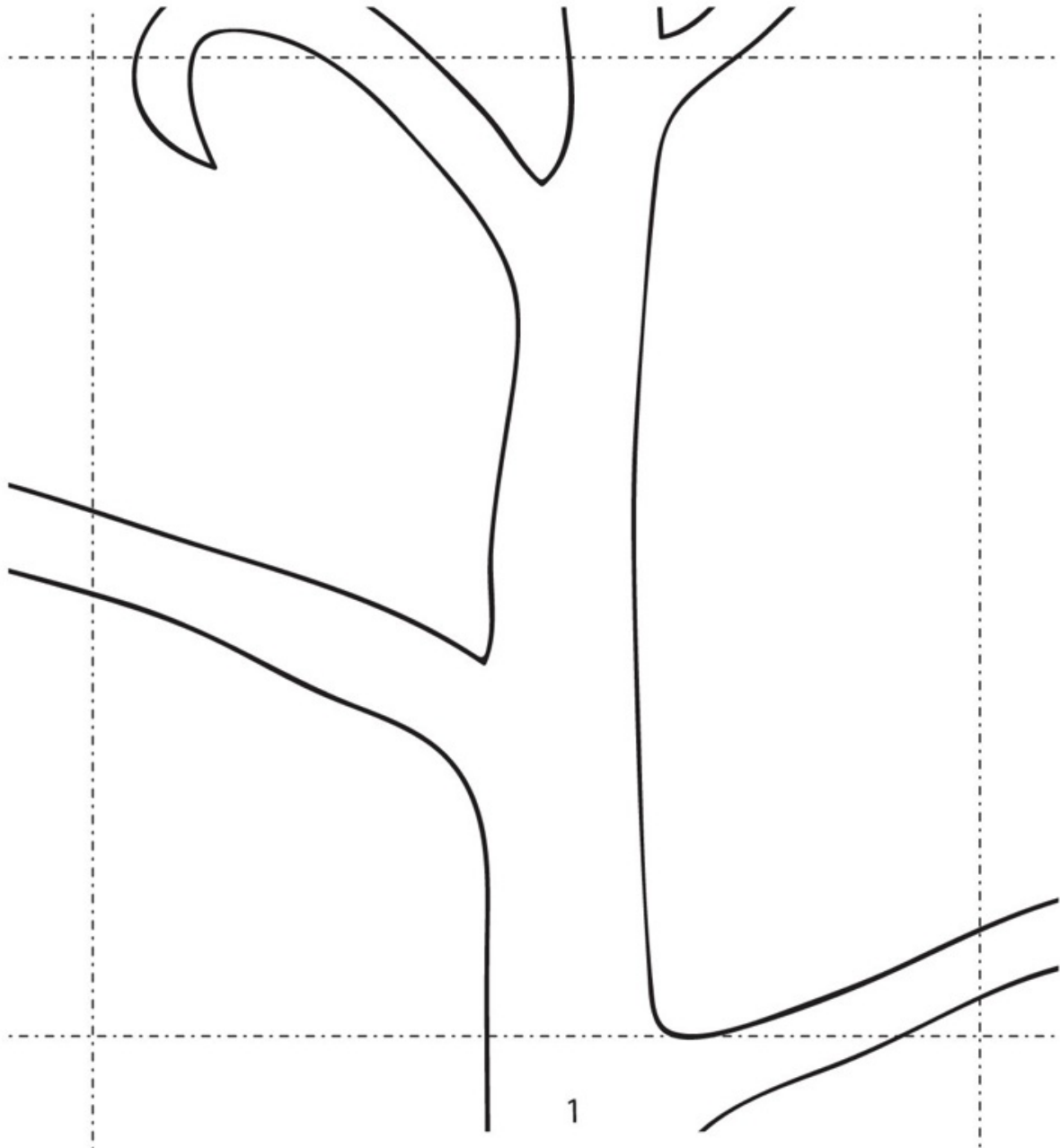
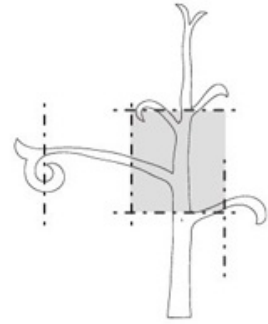
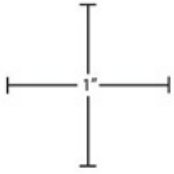

For all printable patterns or digital content: <http://tinyurl.com/11106->

patterns-download

## Merry and Bright: block B

*Note: Patterns are also printed in reverse for fusible appliqué.*

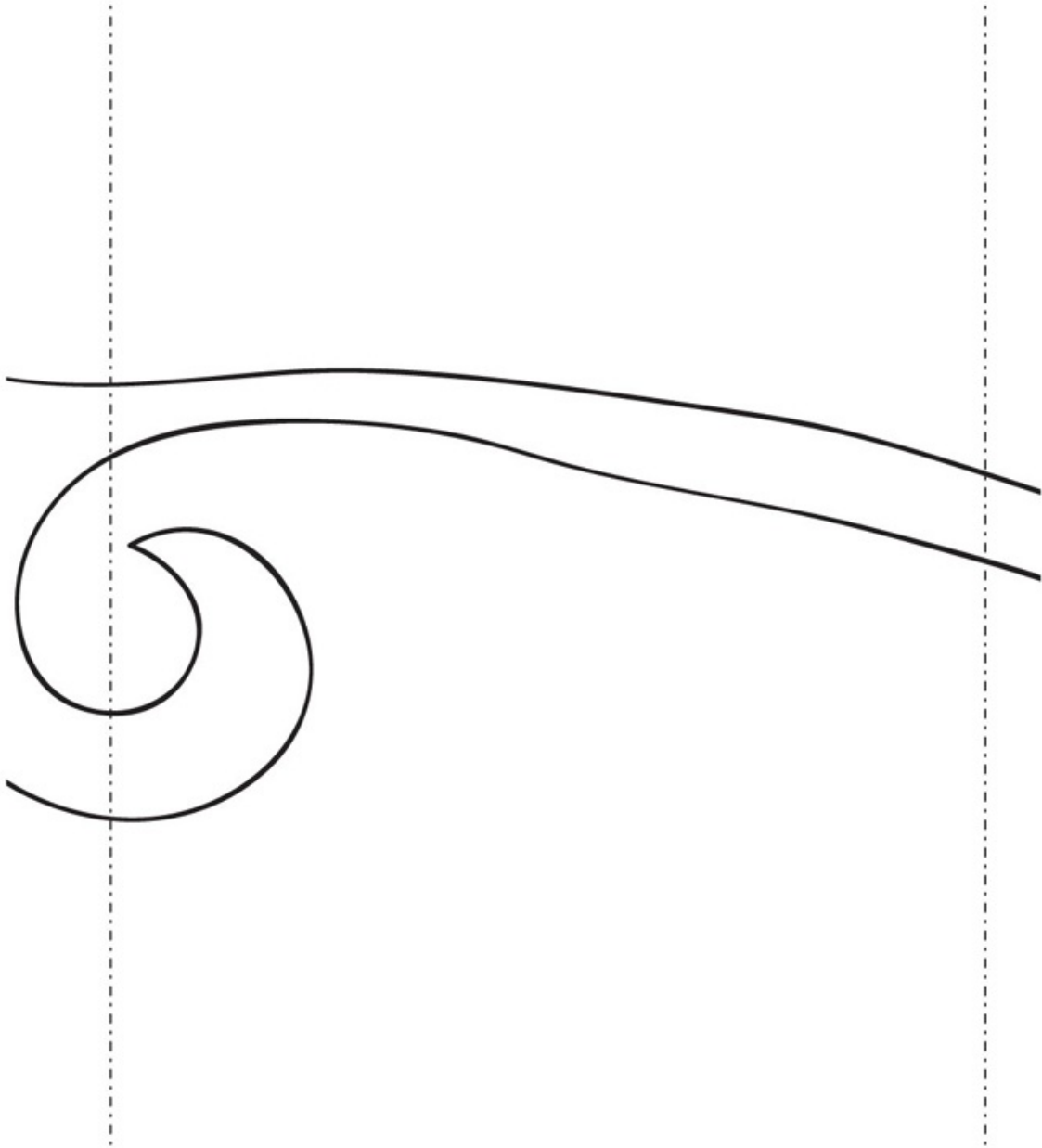
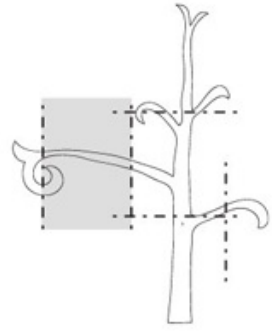
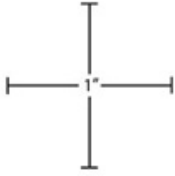

For all printable patterns or digital content: <http://tinyurl.com/11106-patterns-download>

**Merry and Bright: block B**

*Note: Patterns are also printed in reverse for fusible appliqué.*

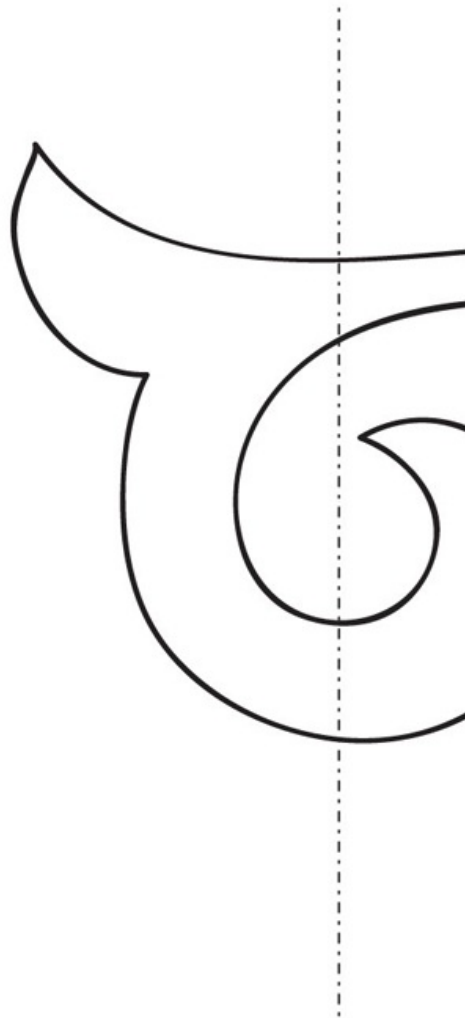
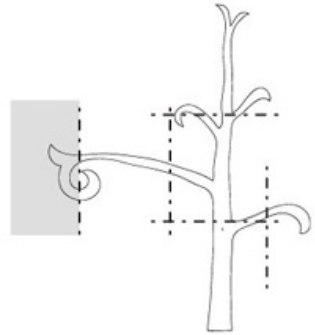
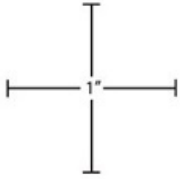

For all printable patterns or digital content: <http://tinyurl.com/11106-patterns-download>

patterns-download

**Merry and Bright: block B**

*Note: Patterns are also printed in reverse for fusible appliqué.*

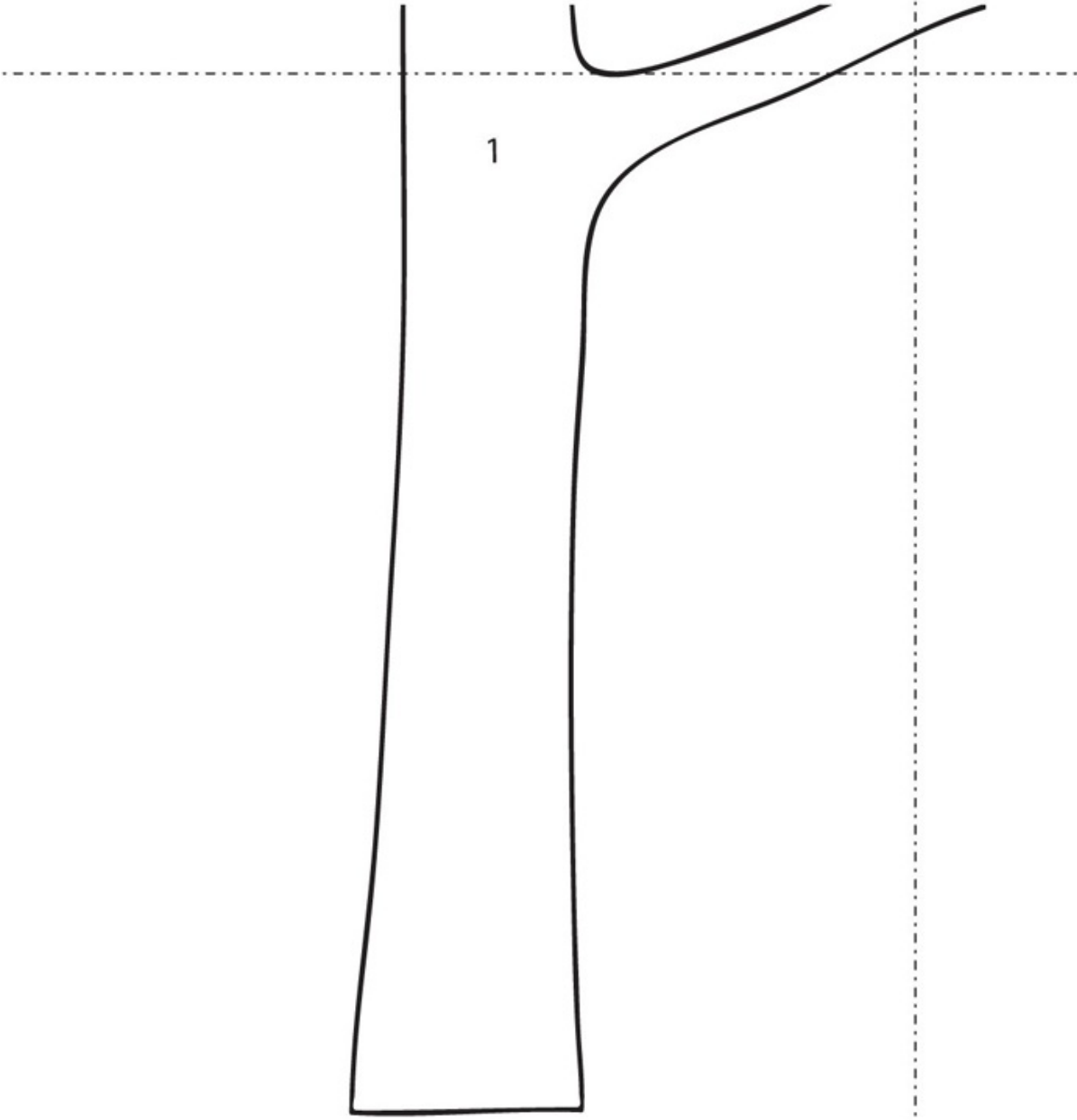
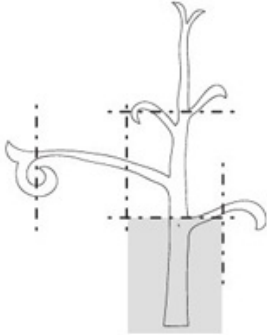
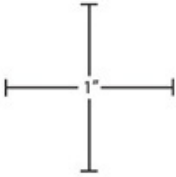

For all printable patterns or digital content: <http://tinyurl.com/11106-patterns-download>

**Merry and Bright: block B**

*Note: Patterns are also printed in reverse for fusible appliqué.*

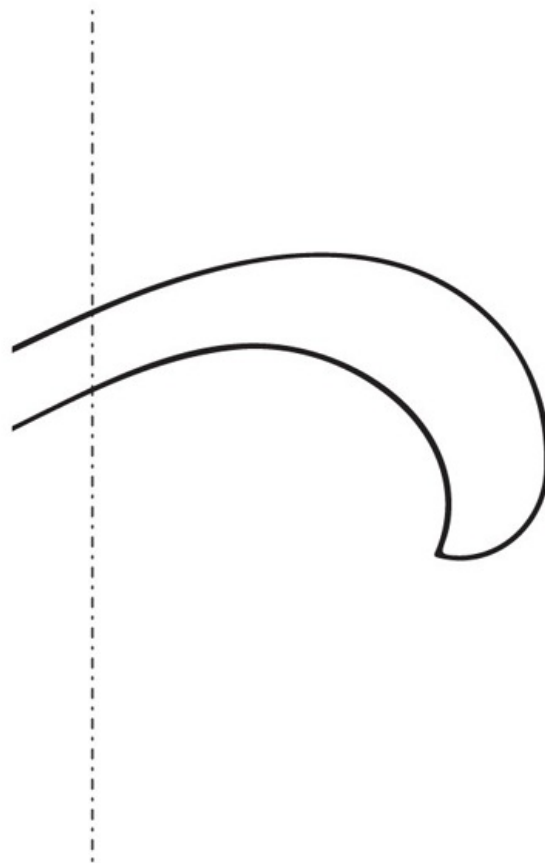
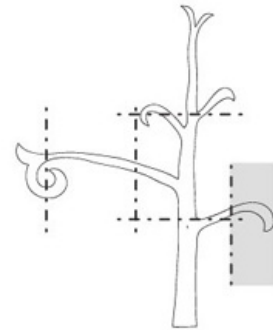
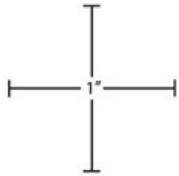

For all printable patterns or digital content: <http://tinyurl.com/11106-patterns-download>



## Merry and Bright: block C

*Note: Patterns are also printed in reverse for fusible appliqué.*

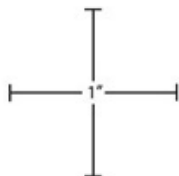

To make complete pattern, join the following pages, following the diagram for reference.

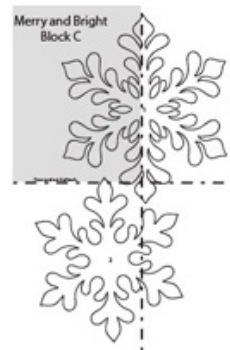

# Merry and Bright Block C

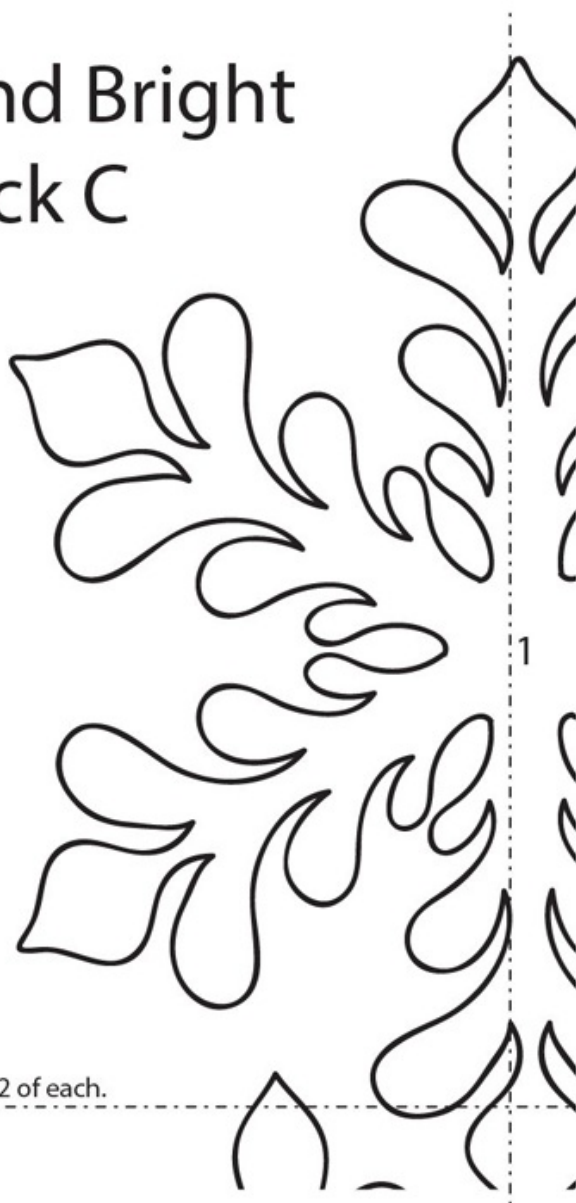

Trace and cut 2 of each.

For all printable patterns or digital content: <http://tinyurl.com/11106-patterns-download>

# Merry and Bright: block C

Note: Patterns are also printed in reverse for fusible appliqué.

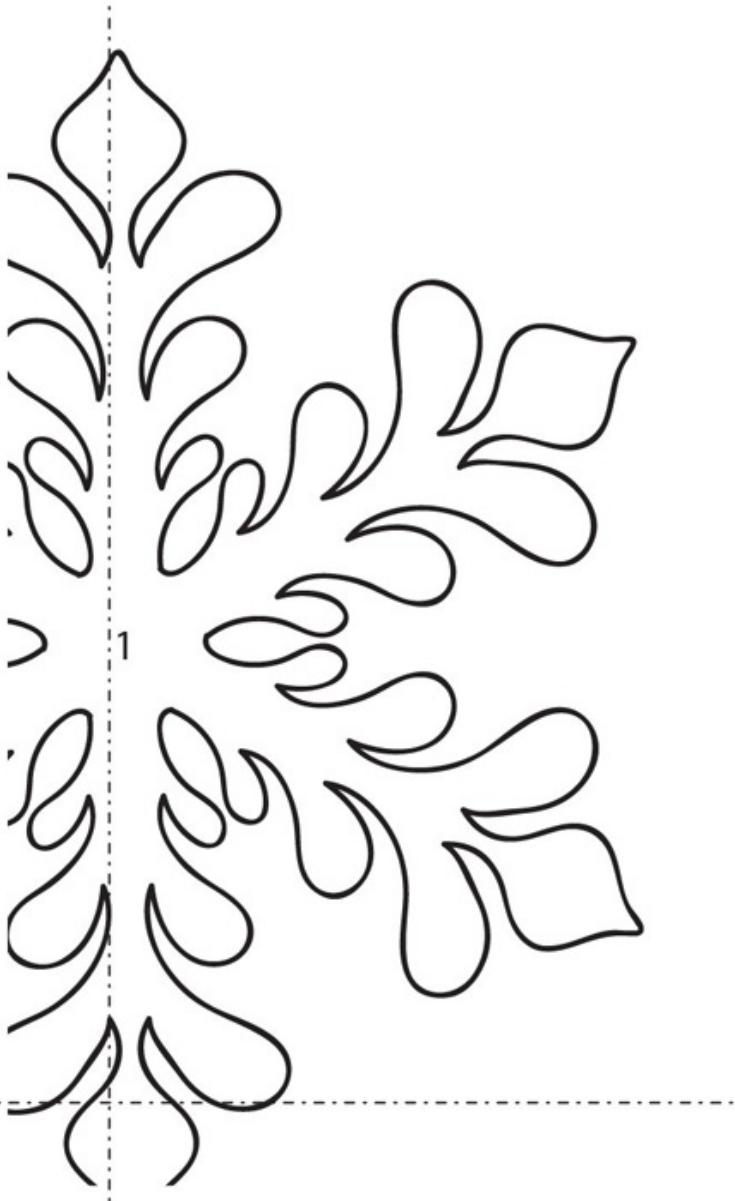
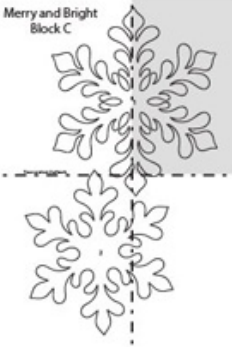
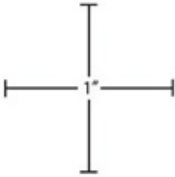

For all printable patterns or digital content: <http://tinyurl.com/11106-patterns-download>

## Merry and Bright: block C

*Note: Patterns are also printed in reverse for fusible appliqué.*

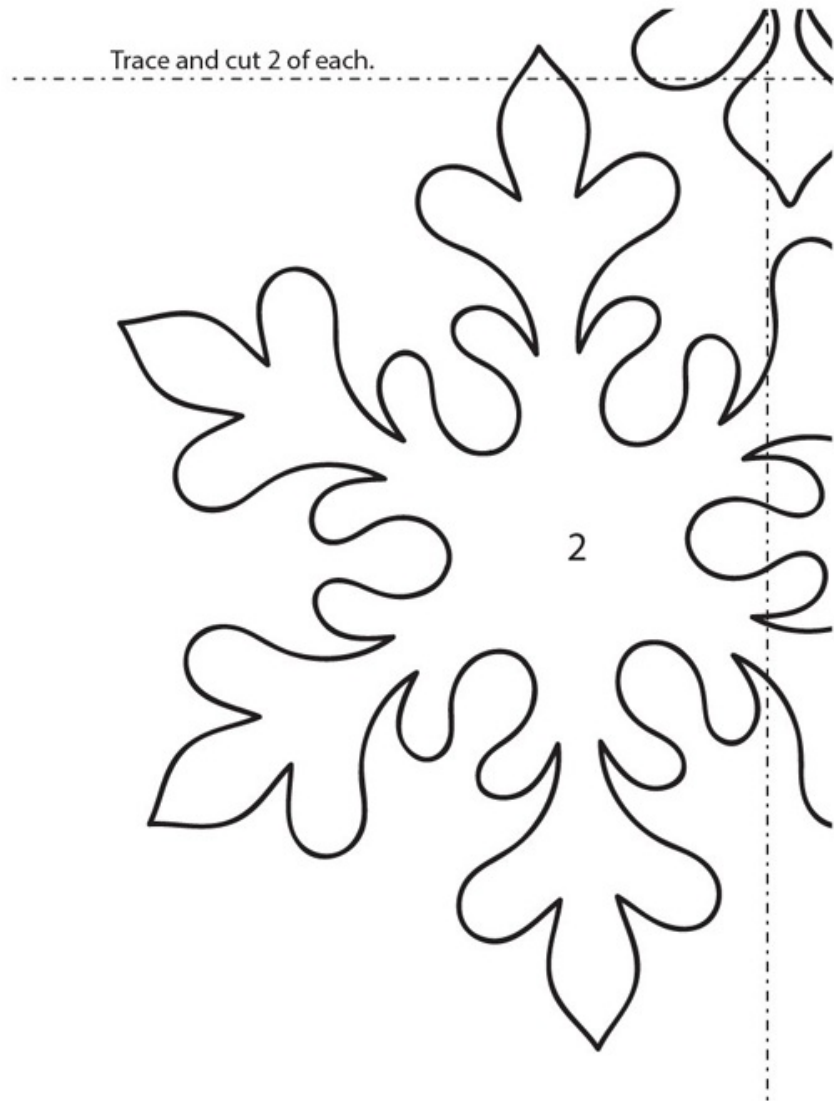
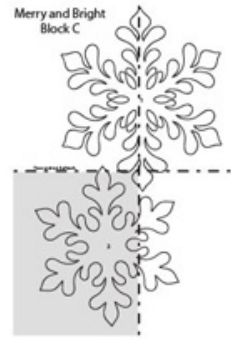
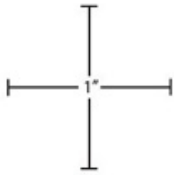

For all printable patterns or digital content: <http://tinyurl.com/11106->

patterns-download

### Merry and Bright: block C

*Note: Patterns are also printed in reverse for fusible appliqué.*

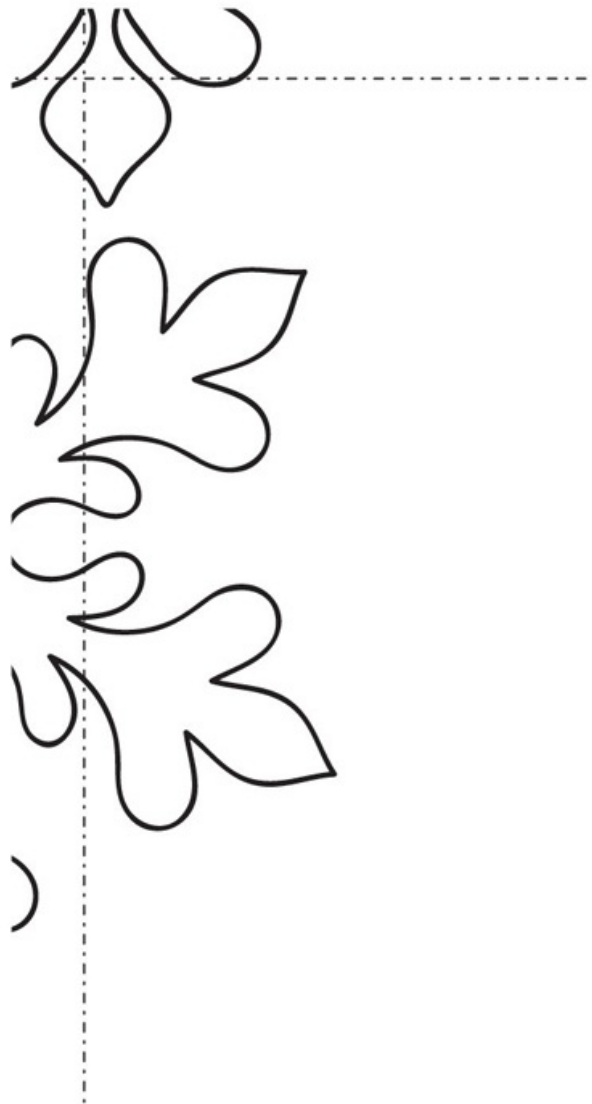
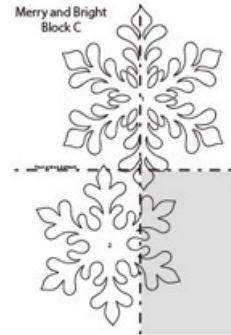
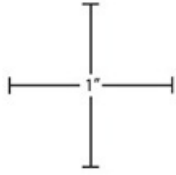

For all printable patterns or digital content: <http://tinyurl.com/11106->

patterns-download

## Merry and Bright: block D

Note: Patterns are also printed in reverse for fusible appliqué.

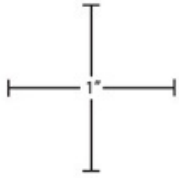

To make complete pattern, join the following pages, following the diagram for reference.

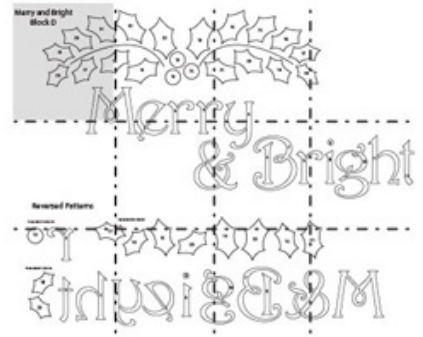

## Merry and Bright Block D

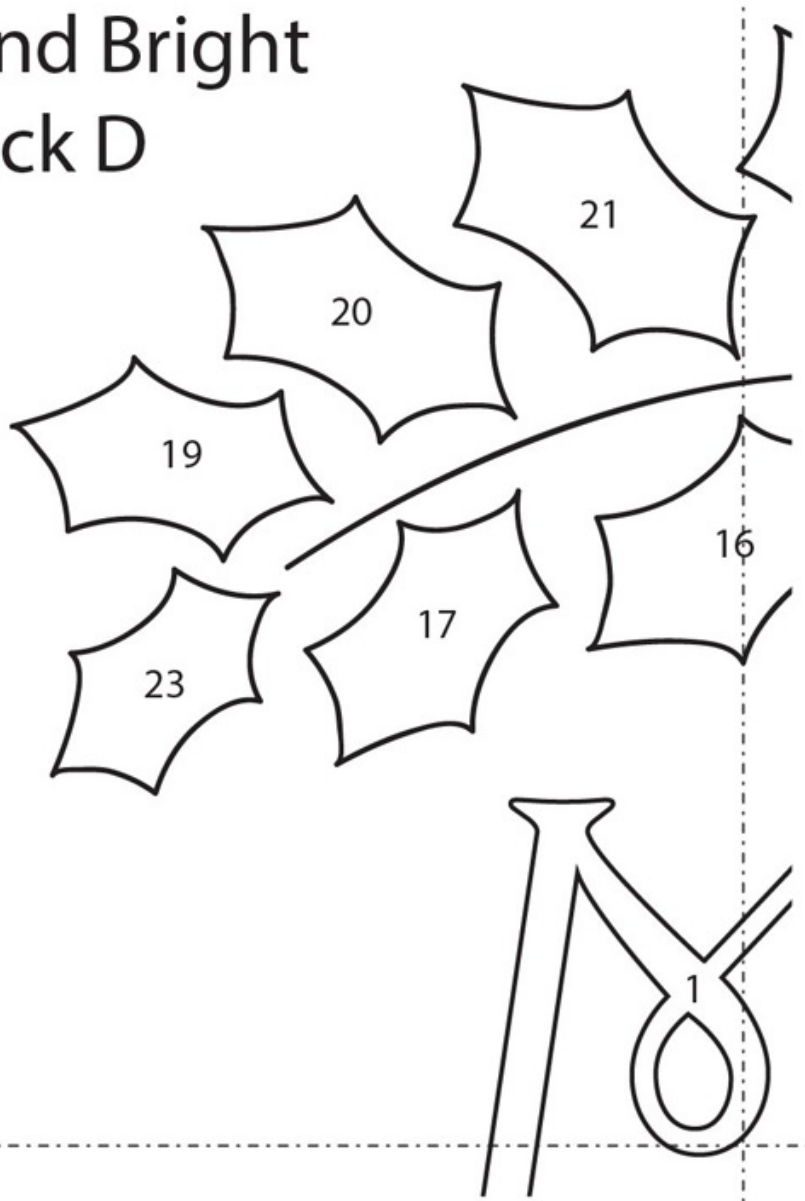



For all printable patterns or digital content: <http://tinyurl.com/11106-patterns-download>

# Merry and Bright: block D

Note: Patterns are also printed in reverse for fusible appliqué.

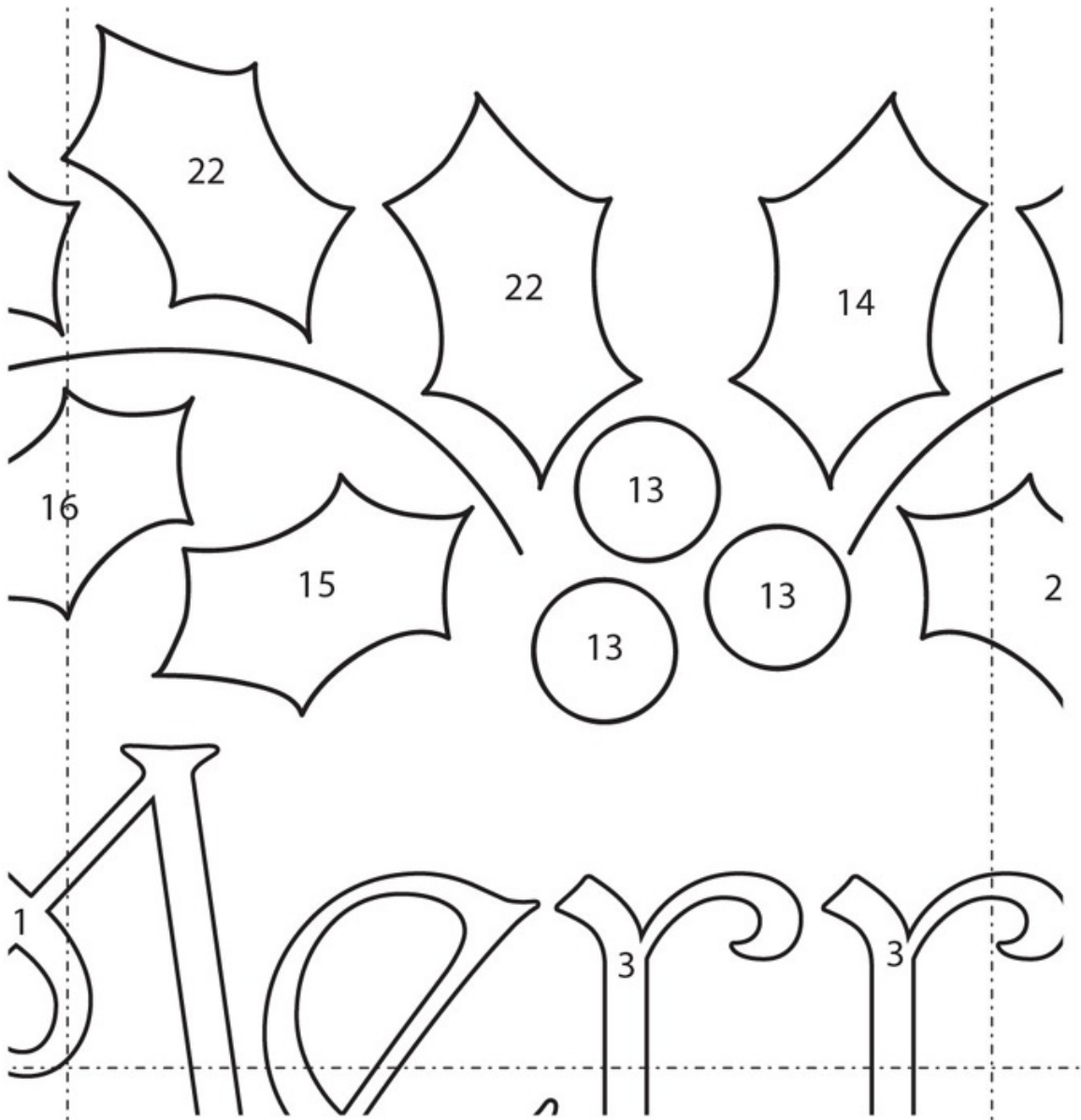
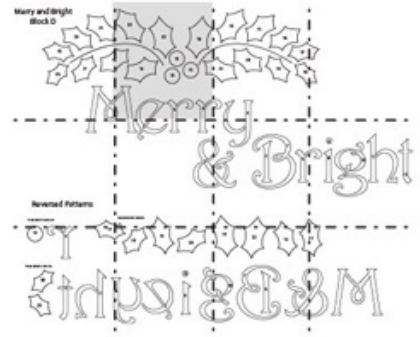
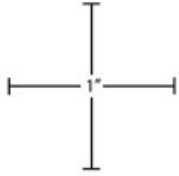

For all printable patterns or digital content: <http://tinyurl.com/11106-patterns-download>

# Merry and Bright: block D

Note: Patterns are also printed in reverse for fusible appliqué.

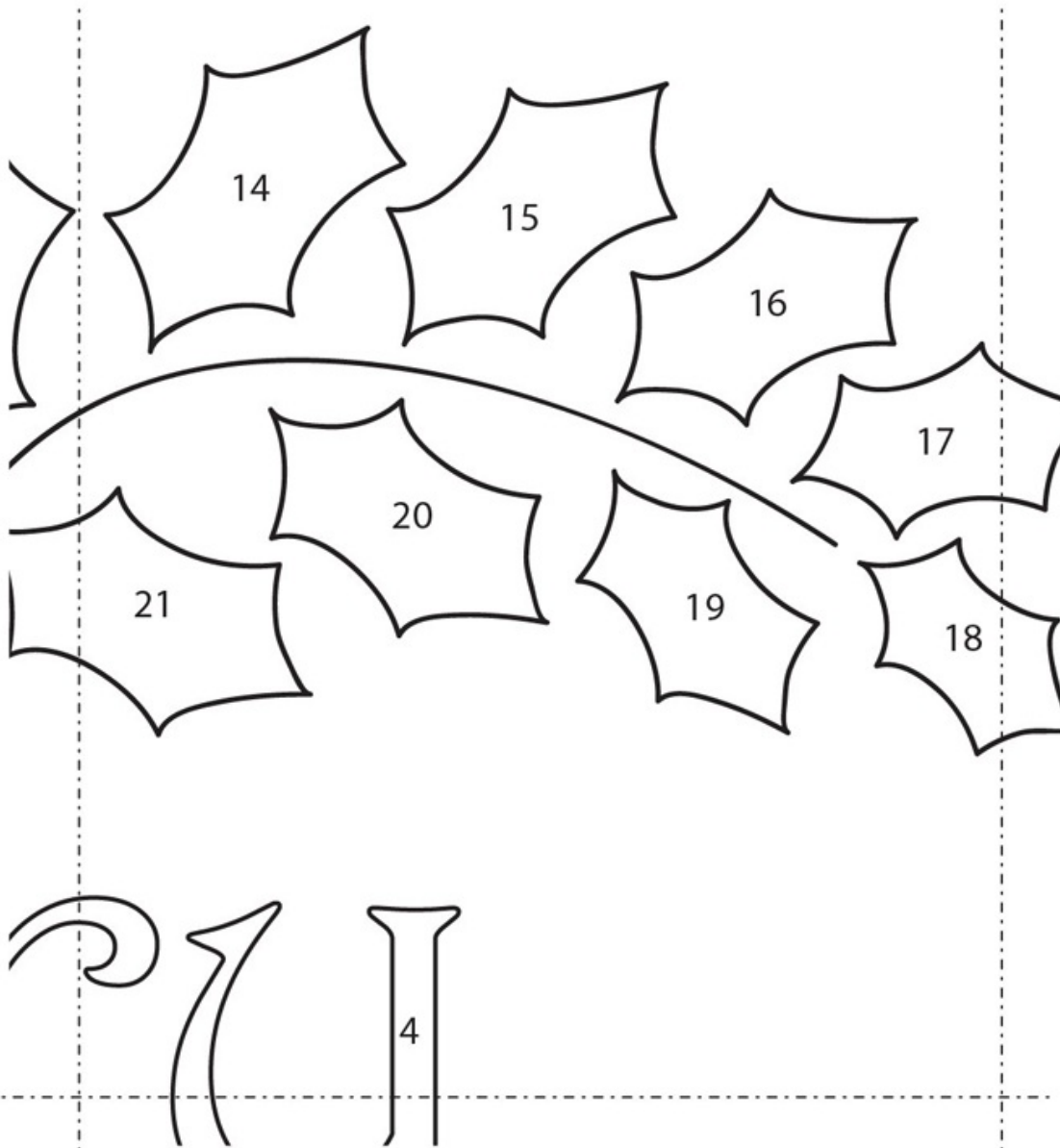
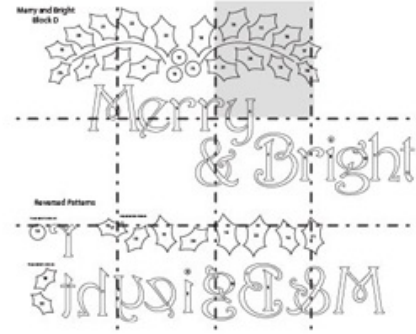
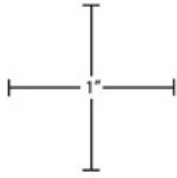

For all printable patterns or digital content: <http://tinyurl.com/11106->

patterns-download

## Merry and Bright: block D

Note: Patterns are also printed in reverse for fusible appliqué.

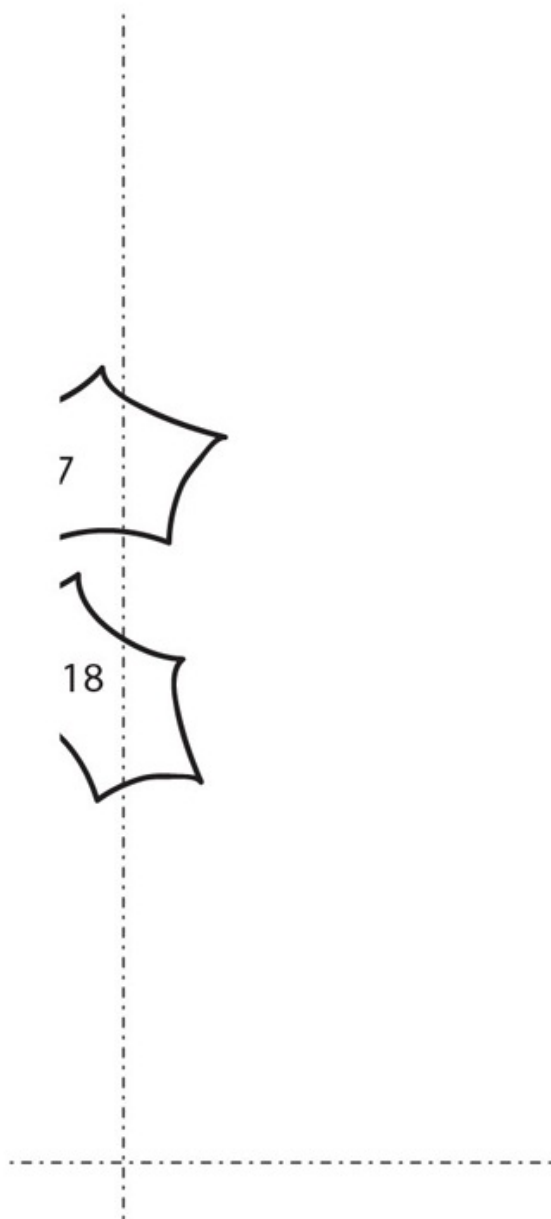
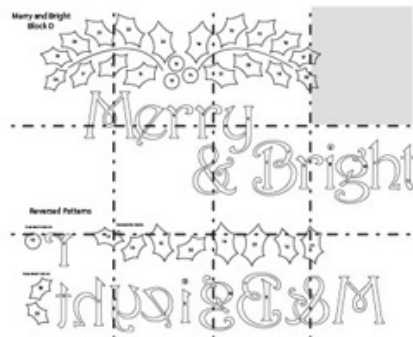
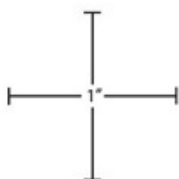

For all printable patterns or digital content: <http://tinyurl.com/11106-patterns-download>

# Merry and Bright: block D

Note: Patterns are also printed in reverse for fusible appliqué.

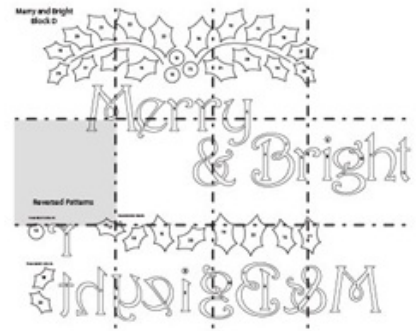
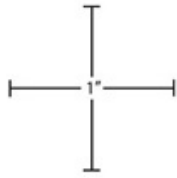

## Reversed Patterns

Trace and cut 3 of each.





For all printable patterns or digital content: <http://tinyurl.com/11106-patterns-download>

# Merry and Bright: block D

Note: Patterns are also printed in reverse for fusible appliqué.

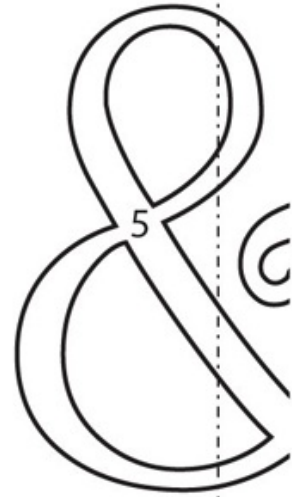
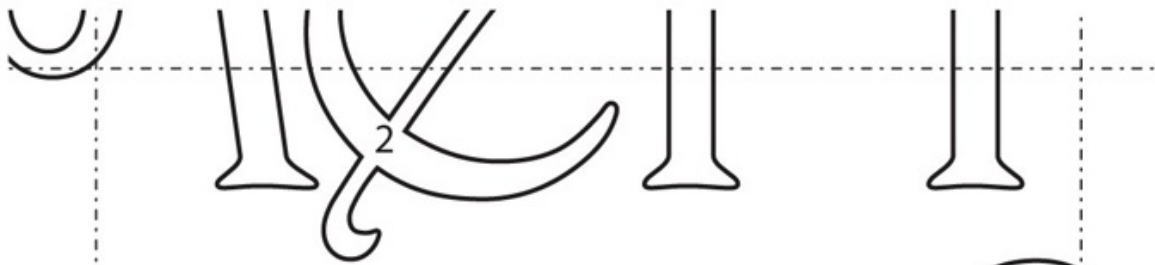
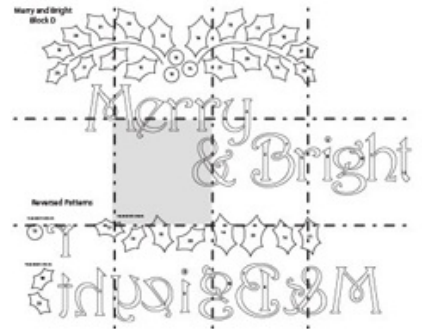
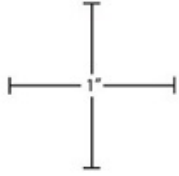

Trace and cut 2 of each.

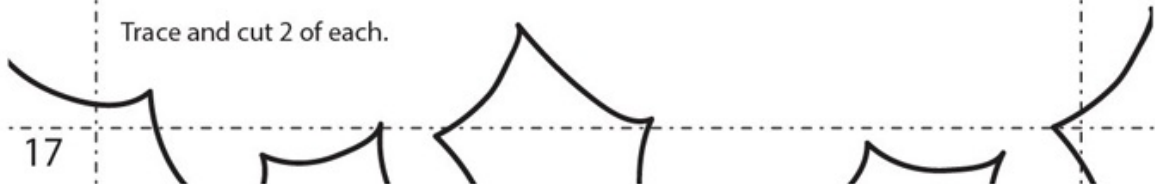

For all printable patterns or digital content: <http://tinyurl.com/11106-patterns-download>

# Merry and Bright: block D

Note: Patterns are also printed in reverse for fusible appliqué.

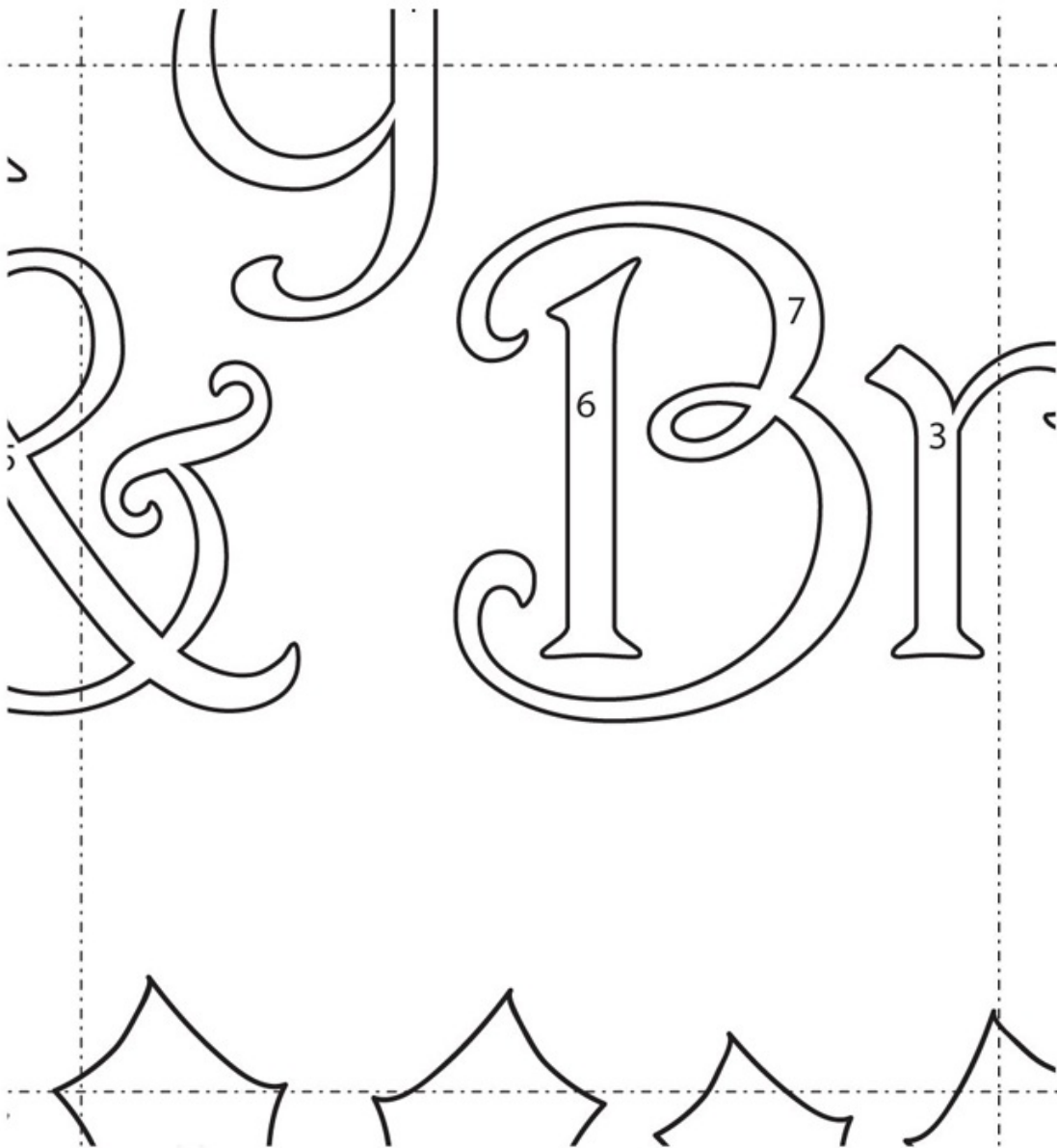
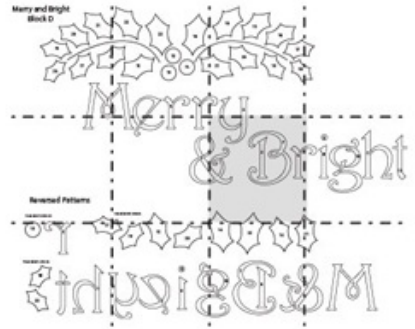
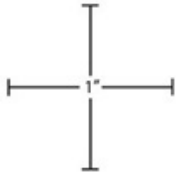

For all printable patterns or digital content: <http://tinyurl.com/11106-patterns-download>

# Merry and Bright: block D

Note: Patterns are also printed in reverse for fusible appliqué.

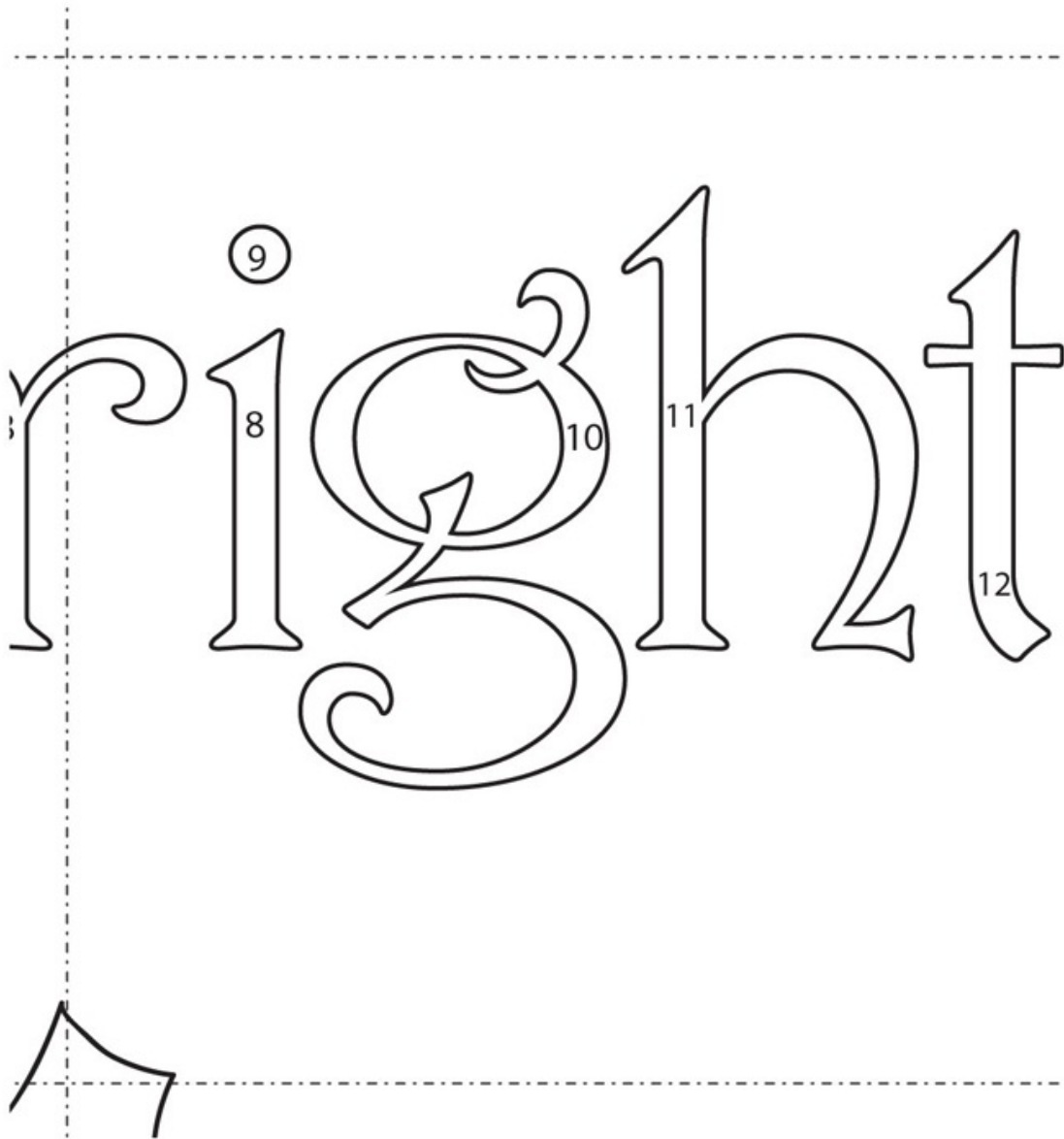
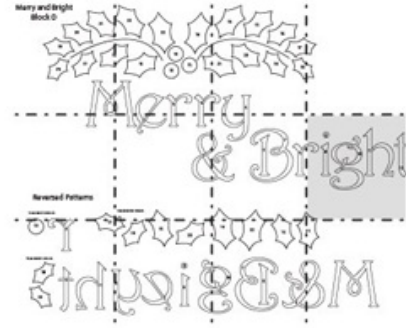
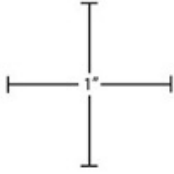

For all printable patterns or digital content: <http://tinyurl.com/11106-patterns-download>

# Merry and Bright: block D

Note: Patterns are also printed in reverse for fusible appliqué.

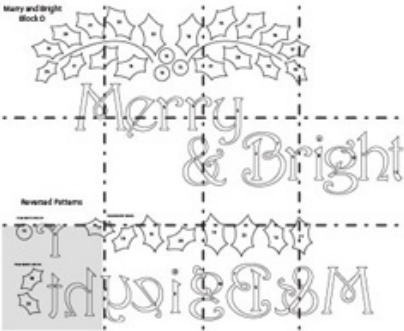
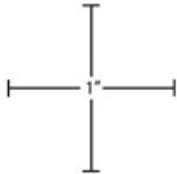

Trace and cut 3 of each.

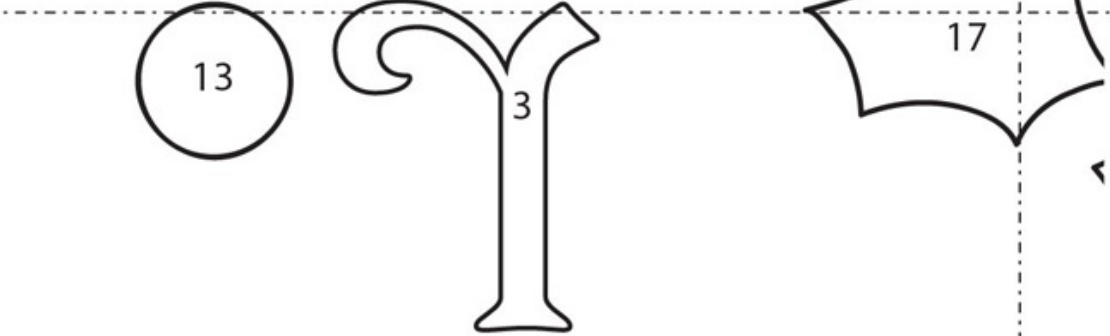

Trace and cut 1 of each.

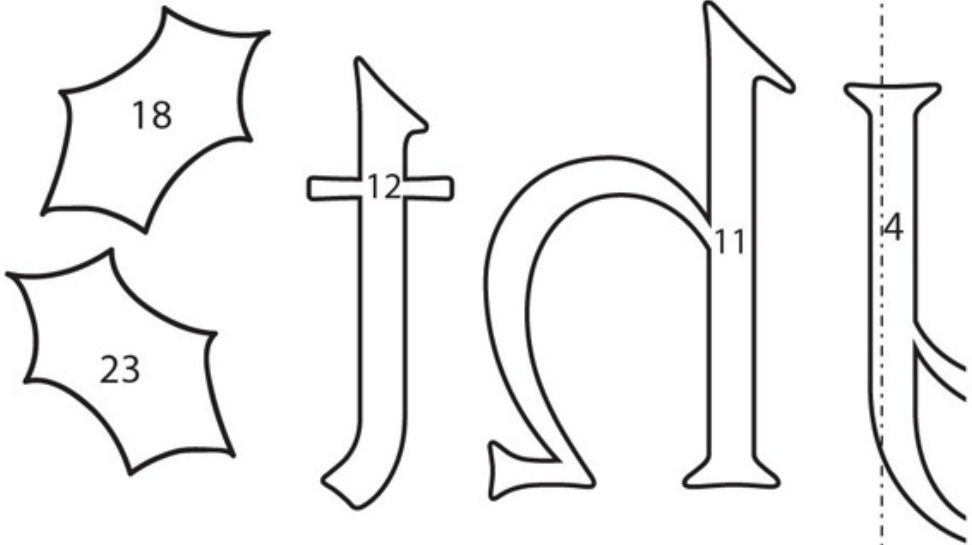



For all printable patterns or digital content: <http://tinyurl.com/11106-patterns-download>

# Merry and Bright: block D

Note: Patterns are also printed in reverse for fusible appliqué.

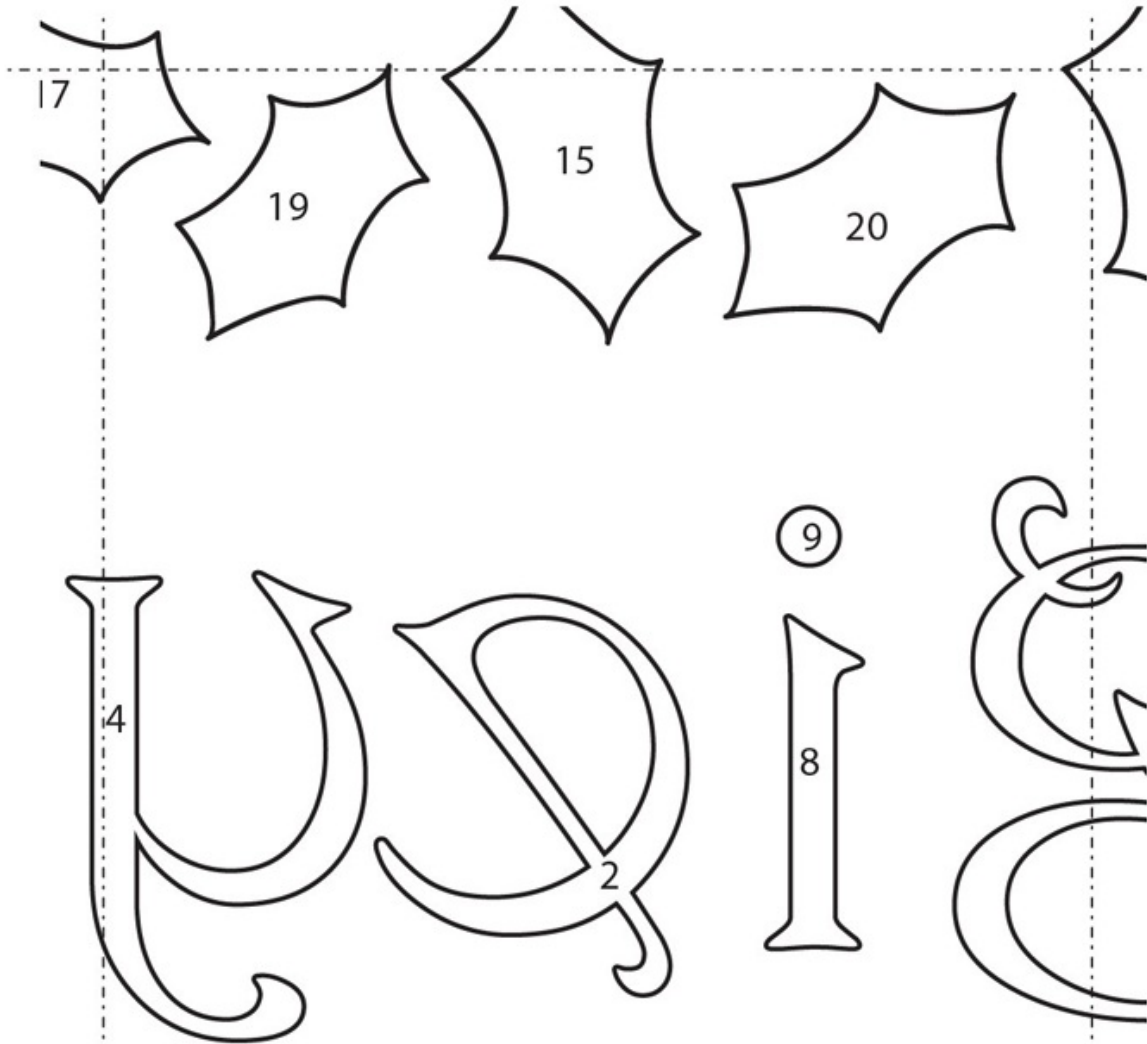
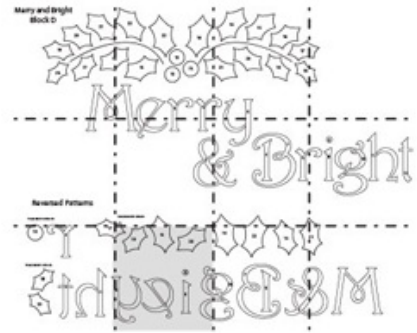
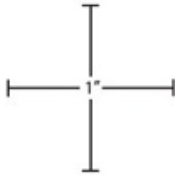

For all printable patterns or digital content: <http://tinyurl.com/11106-patterns-download>

# Merry and Bright: block D

Note: Patterns are also printed in reverse for fusible appliqué.

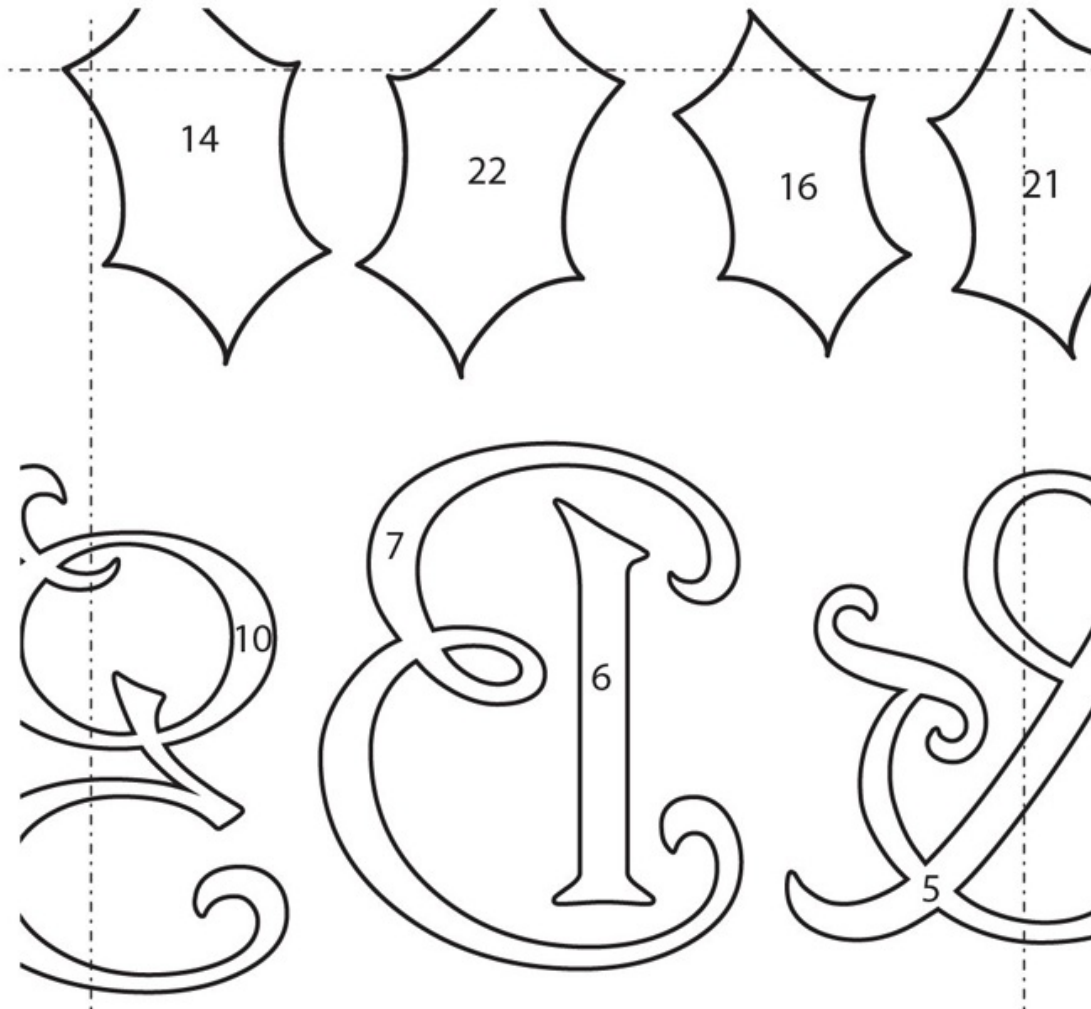
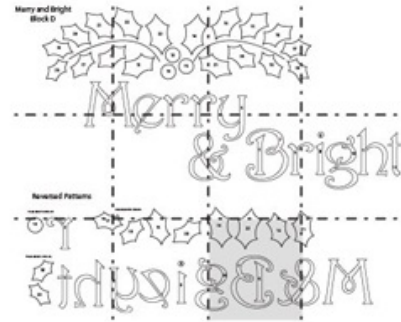
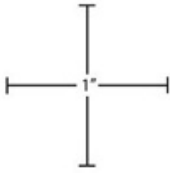

For all printable patterns or digital content: <http://tinyurl.com/11106->

patterns-download

# Merry and Bright: block D

Note: Patterns are also printed in reverse for fusible appliqué.

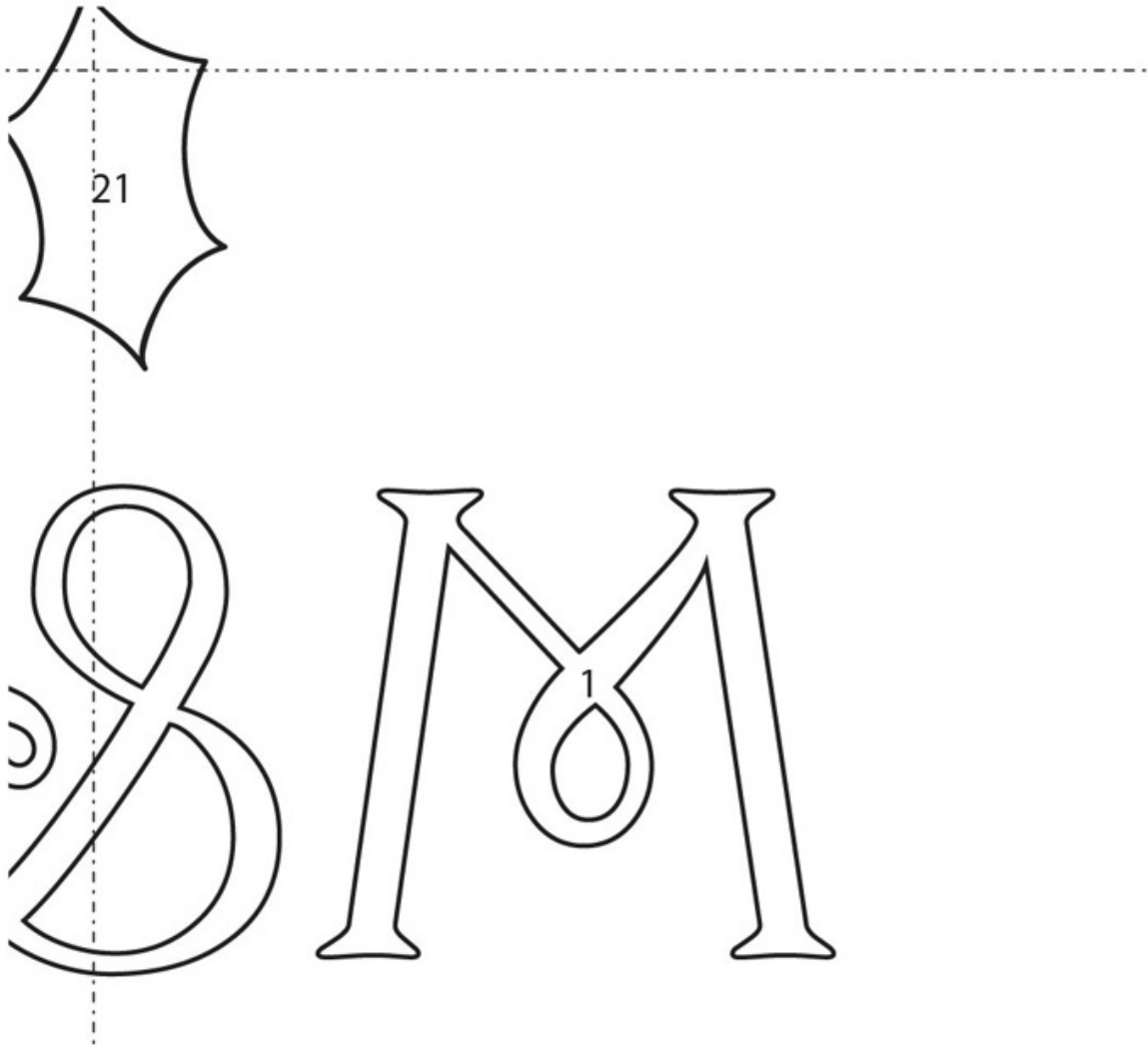
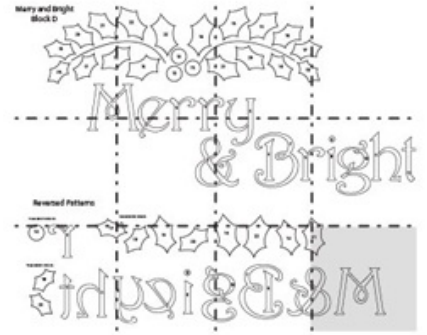
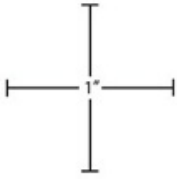

For all printable patterns or digital content: <http://tinyurl.com/11106-patterns-download>

Celebrate the Seasons Download

Copyright © 2014 by C&T Publishing, Inc.

ISBN 978-1-61745-039-6

Published by C&T Publishing, Inc., PO Box 1456, Lafayette, CA 94549. [www.ctpub.com](http://www.ctpub.com)

All rights reserved. No part of this work covered by the copyright hereon may be used in any form or reproduced by any means—graphic, electronic, or mechanical, including photocopying, recording, taping, or information storage and retrieval systems—without written permission from the Publisher.

Acceptable uses of this ELECTRONIC PRODUCT:

1. Purchaser is entitled to print out as many copies of this ELECTRONIC PRODUCT as they wish for personal use. Photocopying, digitizing, and all other forms of copying to “share” or “distribute” the ELECTRONIC PRODUCT, whether for profit or not, is strictly prohibited.
2. Purchaser may not transfer the ELECTRONIC PRODUCT to any other person, via the Internet, email, on disk, in electronic or printed form or any other form without the written permission of C&T Publishing. Purchaser may not make the ELECTRONIC PRODUCT available over a network where it could be used by multiple computers at the same time.
3. Purchaser may not rent, lease, transfer, lend, or share the ELECTRONIC PRODUCT.

Limited Warranty: Limited Warranty on this ELECTRONIC PRODUCT. C&T Publishing, Inc. warrants the ELECTRONIC PRODUCT will be delivered by C&T Publishing, Inc. free from defects in materials and workmanship under normal use for a period of ninety (90) days from the date of original purchase. C&T Publishing, Inc. will not replace the ELECTRONIC PRODUCT due to Purchaser changing computers or accidentally deleting ELECTRONIC PRODUCT or for any other loss of the file that is considered out of the control of C&T Publishing, Inc. Your exclusive remedy under this Section shall be, at C&T Publishing, Inc.’s option, a refund of the purchase price of the ELECTRONIC PRODUCT.

Contact us at 800-284-1114 or [www.ctpub.com](http://www.ctpub.com) for more information about the C&T Teachers Program.

We take great care to ensure that the information included in our products is accurate and presented in good faith, but no warranty is provided nor are results guaranteed. Having no control over the choices of materials or procedures used, neither the author nor C&T Publishing, Inc., shall have any liability to any person or entity with respect to any loss or damage caused directly or indirectly by the information contained in this book. For your convenience, we post an up-to-date listing of corrections on our website ([www.ctpub.com](http://www.ctpub.com)). If a correction is not already noted, please contact our customer service department at [ctinfo@ctpub.com](mailto:ctinfo@ctpub.com) or at P.O. Box 1456, Lafayette, CA 94549.

Trademark (™) and registered trademark (®) names are used throughout this ELECTRONIC PRODUCT. Rather than use the symbols with every occurrence of a trademark or registered trademark name, we are using the names only in the editorial fashion and to the benefit of the owner, with no intention of infringement.

**Pattern Note:** This digital file contains patterns that may not print true to size and may require sizing



adjustments (inchmarks are included on patterns for reference). Depending on your viewing application or device, printing desired page may result in multiple printed pages.



# C&T PUBLISHING

JOIN OUR E-FAMILY

**Pattern  
Spot.com**  
*We get you sewing*

access 1000s of patterns ▶

Best-Selling  
Quilting and  
Stitching apps



now for Android and iPhone! ▶



**eBooks!**  
Instant, Easy,  
Portable & Affordable

go paperless! ▶



**eNewsletter**  
Get Weekly  
Deals!

sign up now ▶

## Join the Conversation

community • free projects • prize giveaways

[stashbooksblog.com](http://stashbooksblog.com)

[ctpubblog](http://ctpubblog.com)



WEB [www.ctpub.com](http://www.ctpub.com)  
EMAIL [ctinfo@ctpub.com](mailto:ctinfo@ctpub.com)

TOLL-FREE IN U.S. 800.284.1114  
INT'L 925.677.0377  
FAX 925.677.0373

For all printable patterns or digital content:  
<http://tinyurl.com/11106-patterns-download>